

# 16 W 12 V 5 V SMPS demo board with ICE5QR4780AZ

AN-DEMO\_5QR4780AZ\_16W1

## About this document

### Scope and purpose

This document is an engineering report that describes a universal input 16 W 12 V and 5 V off-line flyback converter using the latest 5<sup>th</sup> generation Infineon QR CoolSET™ ICE5QR4780AZ which offers high efficiency, low standby power with selectable entry and exit standby power option, wide  $V_{CC}$  operating range with fast start up, robust line protection with input Over Voltage Protection (OVP) and brownout and various other protections for a highly reliable system. This demo board is designed for users who wish to evaluate the performance of ICE5QR4780AZ, especially with regard to ease of use.

### Intended audience

This document is intended for power supply design/application engineers, students, etc. who wish to design low cost and highly reliable off-line Switched Mode Power Supply (SMPS). These can be auxiliary power supplies for white goods, PCs, servers and TVs or enclosed adapters, Blu-ray players, set-top boxes, game consoles, etc.

## Table of contents

<b>About this document</b> .....	<b>1</b>
<b>Table of contents</b> .....	<b>1</b>
<b>1 Abstract</b> .....	<b>3</b>
<b>2 Demo board</b> .....	<b>4</b>
<b>3 Specifications of demo board</b> .....	<b>5</b>
<b>4 Circuit description</b> .....	<b>6</b>
4.1 Line input.....	6
4.2 Start-up.....	6
4.3 Integrated MOSFET and PWM control .....	6
4.4 RCD clamper circuit.....	6
4.5 Output stage.....	6
4.6 Feedback loop .....	6
4.7 Primary side peak current control.....	6
4.8 Digital frequency reduction .....	7
4.9 Active burst mode .....	7
<b>5 Protection features</b> .....	<b>8</b>
<b>6 Circuit diagram</b> .....	<b>9</b>
<b>7 PCB layout</b> .....	<b>11</b>
7.1 Top side .....	11
7.2 Bottom side .....	11
<b>8 BOM</b> .....	<b>12</b>
<b>9 Transformer construction</b> .....	<b>14</b>

**Abstract**

<b>10</b>	<b>Test results .....</b>	<b>15</b>
10.1	Efficiency, regulation and output ripple .....	15
10.2	Standby power .....	16
10.3	Line regulation .....	17
10.4	Load regulation .....	18
10.5	Maximum input power .....	19
10.6	ESD immunity (EN61000-4-2).....	19
10.7	Surge immunity (EN61000-4-5).....	19
10.8	Conducted emissions (EN55022 class B).....	19
10.9	Thermal measurement .....	22
<b>11</b>	<b>Waveforms and scope plots .....</b>	<b>23</b>
11.1	Startup at low/high AC line input voltage with maximum load .....	23
11.2	Soft start .....	23
11.3	Drain and current sense voltage at maximum load.....	24
11.4	Zero crossing point during normal operation.....	24
11.5	Load transient response (dynamic load from 10% to 100%) .....	25
11.6	Output ripple voltage at maximum load.....	25
11.7	Output ripple voltage in active burst mode 1 W load .....	26
11.8	Entering active burst mode.....	26
11.9	During active burst mode.....	27
11.10	Leaving active burst mode.....	27
11.11	Line over voltage protection (non switch auto restart) .....	28
11.12	Brownout protection (non switch auto restart).....	28
11.13	V <sub>CC</sub> over voltage protection (odd skip auto restart) .....	29
11.14	V <sub>CC</sub> under voltage protection (auto restart).....	29
11.15	Over load protection (odd skip auto restart) .....	30
11.16	Output over voltage protection (odd skip auto restart) .....	30
11.17	V <sub>CC</sub> short to GND protection .....	31
<b>12</b>	<b>References .....</b>	<b>32</b>
	<b>Revision history .....</b>	<b>32</b>

### Abstract

## 1 Abstract

This application note is an engineering report for a 16 W 12 V and 5 V demo board designed in a QR flyback converter topology using the 5<sup>th</sup> generation QR CoolSET™ ICE5QR4780AZ. The target applications for the ICE5QR4780AZ are either power supplies from white goods, PCs, servers and TVs or enclosed adapters, Blu-ray players, set-top boxes, game consoles, etc.

With the CoolMOS™ integrated in this IC, it greatly simplifies the design and layout of the PCB. The novel and improved digital frequency reduction with proprietary QR operation offers lower EMI and higher efficiency for a wide AC range by reducing the switching frequency difference between low- and high-line. The enhanced active burst mode power enables flexibility in standby power operation range selection and QR operation during active burst mode. As a result, the system efficiency over the entire load range is significantly improved compared to conventional free running QR converters implemented with only maximum switching frequency limitation at light load.

In addition, numerous adjustable protection functions have been implemented in the ICE5QR4780AZ to protect the system and customize the IC for the chosen application. In case of failure modes such as brownout or line over voltage,  $V_{CC}$  over/under voltage, open control loop or overload, output overvoltage, over temperature,  $V_{CC}$  short to ground or CS short to ground, the device enters a protection mode.

Due to the cycle-by-cycle peak current limitation, the dimensions of the transformer and current rating of the secondary diode can both be optimized. Thus, a cost effective solution can easily be achieved.

## 2 Demo board

This document contains a list of features, the power supply specification, schematic, Bill of Material (BOM) and the transformer construction documentation. Typical operating characteristics such as performance curves and oscilloscope waveforms are shown at the end of the report.

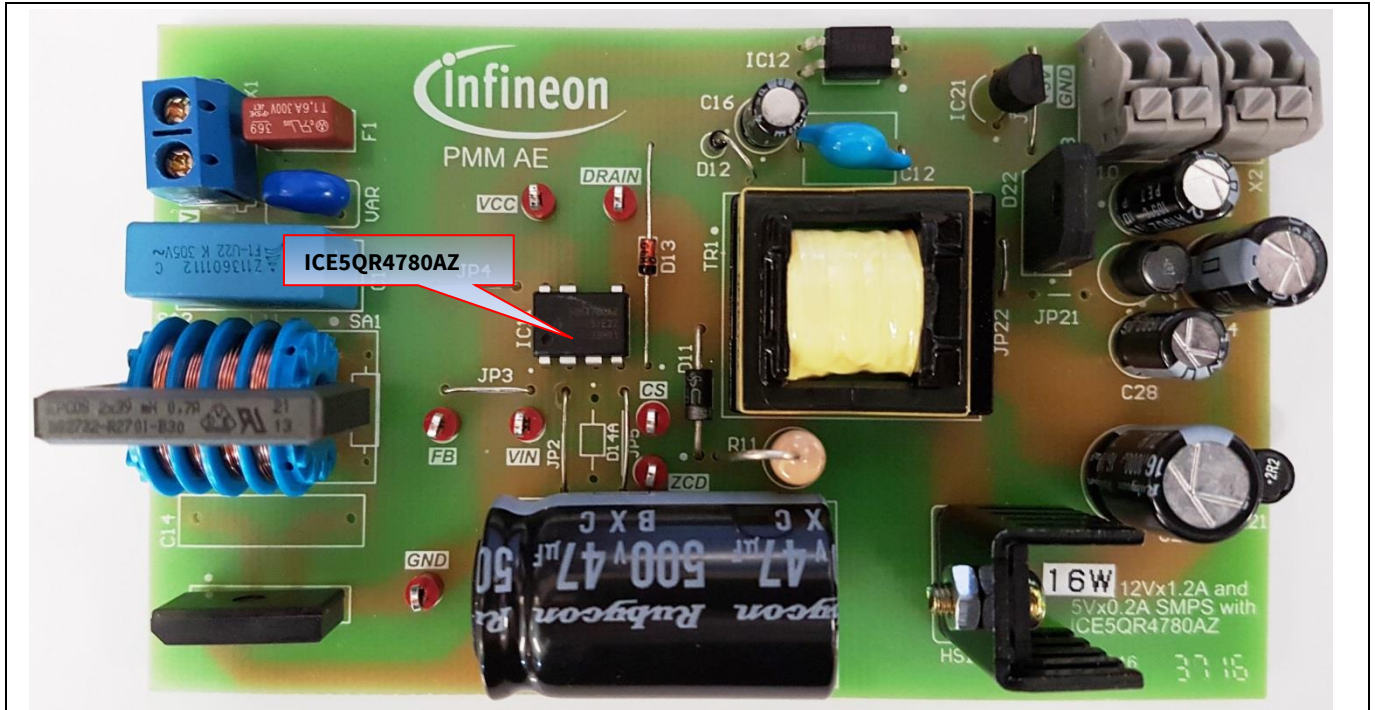

Figure 1 DEMO\_5QR4780AZ\_16W1

### 3 Specifications of demo board

**Table 1 Specifications of DEMO\_5QR4780AZ\_16W1**

Input voltage and frequency	85 V AC (60 Hz) ~ 300 V AC (50Hz)
Output voltage, current and power	(12 V x 1.25 A) +(5 V x 0.2 A) = 16 W
Dynamic load response (5 V at 0.2 A and 12 V load change from 10% to 100%, slew rate at 0.4 A/μs, 100 Hz)	±5% of nominal output voltage
Output ripple voltage (full load, 85 V AC ~ 300 V AC)	5 V <sub>ripple_p_p</sub> < 100 mV 12 V <sub>ripple_p_p</sub> < 100 mV
Active mode four point average efficiency (25%, 50%, 75%, 100% load)	> 84% at 115 V AC and 230 V AC
No load power consumption	< 100 mW at 230 V AC
Conducted emissions (EN55022 class B)	Pass with 8 dB margin for 115 V AC and 6 dB margin for 230 V AC
ESD immunity (EN61000-4-2)	Special Level (±14 kV for contact and ±16 kV air discharge)
Surge immunity (EN61000-4-5)	Installation class 4 (±2 kV for line to line and ±4 kV for line to earth)
Form factor case size (L x W x H)	(110 x 66 x 27) mm <sup>3</sup>

Note: *“The demo board is designed for dual outputs with cross regulated loop feedback. It may not regulate properly if loading is applied only to a single output. If the user wants to evaluate for a single output (12 V only) condition, the following changes are necessary on the board.*

1. Remove D22, L22, C28, C210, R25A (to disable 5 V output)
2. Change R26 to 10 kΩ and R25 to 38 kΩ (to disable 5 V feedback and enable 100% weighted factor on 12 V output)

*Since the board (especially the transformer) is designed for dual output with optimized cross regulation, single output efficiency might not be optimized. It is only intended for IC functional evaluation under single output conditions.”*

**Circuit description**

## **4 Circuit description**

### **4.1 Line input**

The AC line input side comprises the input fuse F1 as over current protection. The choke L11, X-capacitor C11 and Y-capacitor C12 act as EMI suppressors. Optional spark gap devices SA1, SA2 and varistor VAR can absorb high voltage stress during lightning surge test. A rectified DC voltage (120~424 V DC) is obtained through the bridge rectifier BR1 together with the bulk capacitor C13.

### **4.2 Start-up**

To achieve fast and safe start-up, ICE5QR4780AZ has a startup resistor and  $V_{CC}$  short to GND protection. When  $V_{CC}$  reaches the turn-on voltage threshold of 16 V, the IC begins with a soft-start. The soft-start implemented in ICE5QR4780AZ is a digital time-based function. The preset soft-start time is 12 ms with 4 steps. If not limited by other functions, the peak voltage on the CS pin will increase step by step from 0.3 V to 1 V finally. After the IC turns on,  $V_{CC}$  is supplied by the auxiliary windings of the transformer.  $V_{CC}$  short to GND protection is implemented during the startup time.

### **4.3 Integrated MOSFET and PWM control**

ICE5QR4780AZ is comprised of a power MOSFET and the novel, proprietary, QR controller that enables higher average efficiency and low EMI. This integrated solution greatly simplifies the circuit layout and reduces the cost of PCB manufacturing. The PWM switch-on is determined by the Zero Crossing Detection (ZCD) input signal and the value of the up/down counter. The PWM switch-off is determined by the feedback signal  $V_{FB}$  and the current sensing signal  $V_{CS}$ . ICE5QR4780AZ also performs all necessary protection functions in Flyback converters. Full details regarding this are contained in the product datasheet.

### **4.4 RCD clamper circuit**

A clamper network (R11, C15 and D11) dissipates the energy of the leakage inductance and suppresses ringing on the SMPS transformer.

### **4.5 Output stage**

There are two outputs on the secondary side, 12 V and 5 V. The power is coupled out via Schottky diodes D21 and D22. Capacitors C22 and C28 provide energy buffering followed by the L-C filters L21-C24 and L22-C210 to reduce the output ripple and prevent interference between the SMPS switching frequency and the line frequency. Storage capacitors C22 and C28 are designed to have an internal resistance (ESR) that is as small as possible to minimize the output voltage ripple caused by the triangular current.

### **4.6 Feedback loop**

For feedback, the output is sensed by the voltage divider of R26, R25, R25A and compared to IC21's (TL431) internal reference voltage. C25, C26 and R24 comprise the compensation network. The output voltage of IC21 (TL431) is converted to a current signal via optocoupler IC12 and two resistors R22 and R23 for regulation control.

### **4.7 Primary side peak current control**

The MOSFET drain source current is sensed via external resistors R14 and R14A. As ICE5QR4780AZ is a current mode controller, it has a cycle-by-cycle primary current and feedback voltage control that ensures that the maximum power of the converter is controlled during every switching cycle.

**Circuit description**

For a QR Flyback converter, the maximum possible output power is increased when a constant current limit value is used for the entire line input voltage range. This is usually not desired, as this will increase the cost of the transformer and output diode in the case of output over power conditions.

Internal current limitation with line dependent  $V_{CS}$  curve and the proprietary novel QR switching that reduces the switching frequency difference between minimum and maximum line are implemented in the ICE5QR4780AZ. As a result, the maximum output power can be effectively limited against the input voltage.

## 4.8 Digital frequency reduction

During normal operation, the switching frequency for ICE5QR4780AZ is digitally reduced with decreasing load. At light load, the MOSFET will not be turned at the first minimum drain-source voltage time, but on the  $n^{\text{th}}$ . The counter is in the range of 1 to 8 for low line and 3 to 10 for high line, which depends on the feedback voltage in a time-base. The feedback voltage decreases when the output power requirement decreases, and vice versa. Therefore, the counter is set by monitoring voltage  $V_{FB}$ . The counter will be increased with low  $V_{FB}$  and decreased with high  $V_{FB}$ . The thresholds are preset inside the IC.

## 4.9 Active burst mode

Active burst mode entry and exit power (2 levels) can be selected in the ICE5QR4780AZ. Details of this are shown in the product datasheet. Active burst mode power level 1 is used in this demo board (R17=open). At light load conditions, the SMPS enters into active burst mode with QR switching. At this stage, the controller is always active but  $V_{CC}$  must be kept above the switch-off threshold. During active burst mode, the efficiency increases significantly and simultaneously supports low ripple on  $V_{out}$  and fast response on load jump.

For determination of entering active burst mode operation, three conditions apply:

1. the feedback voltage is lower than the threshold of  $V_{FB\_EBLX}$
2. the up/down counter is 8 for low line and 10 for high line and
3. a certain blanking time ( $t_{FB\_BEB} = 20$  ms).

Once all of these conditions are fulfilled, the active burst mode flip-flop is set and the controller enters active burst mode operation. This multi condition determination for entering active burst mode operation prevents mis-triggering, so that the controller enters active burst mode operation only when the output power is actually low during the preset blanking time.

During active burst mode, the maximum current sense voltage is reduced from  $V_{CS\_N}$  to  $V_{CS\_BLX}$  so as to reduce conduction loss and audible noise. At burst mode, the feedback voltage is a sawtooth between  $V_{FB\_BOFF}$  and  $V_{FB\_BON}$ .

The feedback voltage immediately increases if there is a significant load jump. This is observed by one comparator. As the current limit is 31/35% during active burst mode a certain load is needed so that the feedback voltage can exceed  $V_{FB\_LB}$ . After leaving active burst mode, maximum current can now be provided to stabilize  $V_{out}$ . In addition, the up/down counter will be set to 1 (low line) or 3 (high line) immediately after leaving active burst mode. This is helpful to decrease the output voltage undershoot.

## Protection features

## 5 Protection features

Protection is one of the major factors to determine whether the system is safe and robust. Therefore, sufficient protection is necessary. ICE5QR4780AZ provides comprehensive protection to ensure that the system is operating safely. The protections include line over voltage, brownout,  $V_{CC}$  over voltage and under voltage, overload, output over voltage, over temperature (controller junction), CS short to GND and  $V_{CC}$  short to GND. When those faults are found, the system will enter protection mode. When the fault is removed, the system resumes normal operation. A list of protections and the failure conditions are shown in the table below.

**Table 2 Protection function of ICE5QR4780AZ**

Protection function	Failure condition	Protection mode
Line over voltage	$V_{VIN} > 2.9 \text{ V}$	Non switch auto restart
Brownout	$V_{VIN} < 0.4 \text{ V}$	Non switch auto restart
$V_{CC}$ over voltage	$V_{VCC} > 25.5 \text{ V}$	Odd skip auto restart
$V_{CC}$ under voltage	$V_{VCC} < 10 \text{ V}$	Auto restart
Overload	$V_{FB} > 2.75 \text{ V}$ & last for 30 ms	Odd skip auto restart
Output over voltage	$V_{ZCD} > 2 \text{ V}$ & last for 10 consecutive pulses	Odd skip auto restart
Over temperature (Junction temperature of controller chip only)	$T_J > 140 \text{ }^\circ\text{C}$ with $40^\circ\text{C}$ hysteresis to reset	Non switch auto restart
CS short to GND	$V_{CS} < 0.1 \text{ V}$ , last for 5 $\mu\text{s}$ and 3 consecutive pulses	Odd skip auto restart
$V_{CC}$ short to GND ( $V_{VCC}=0 \text{ V}$ , $R_{StartUp}=50 \text{ M}\Omega$ and $V_{DRAIN}=90 \text{ V}$ )	$V_{VCC} < 1.1 \text{ V}$ , $I_{VCC\_Charge1} \approx 0.2 \text{ A}$	Cannot start up



6 Circuit diagram

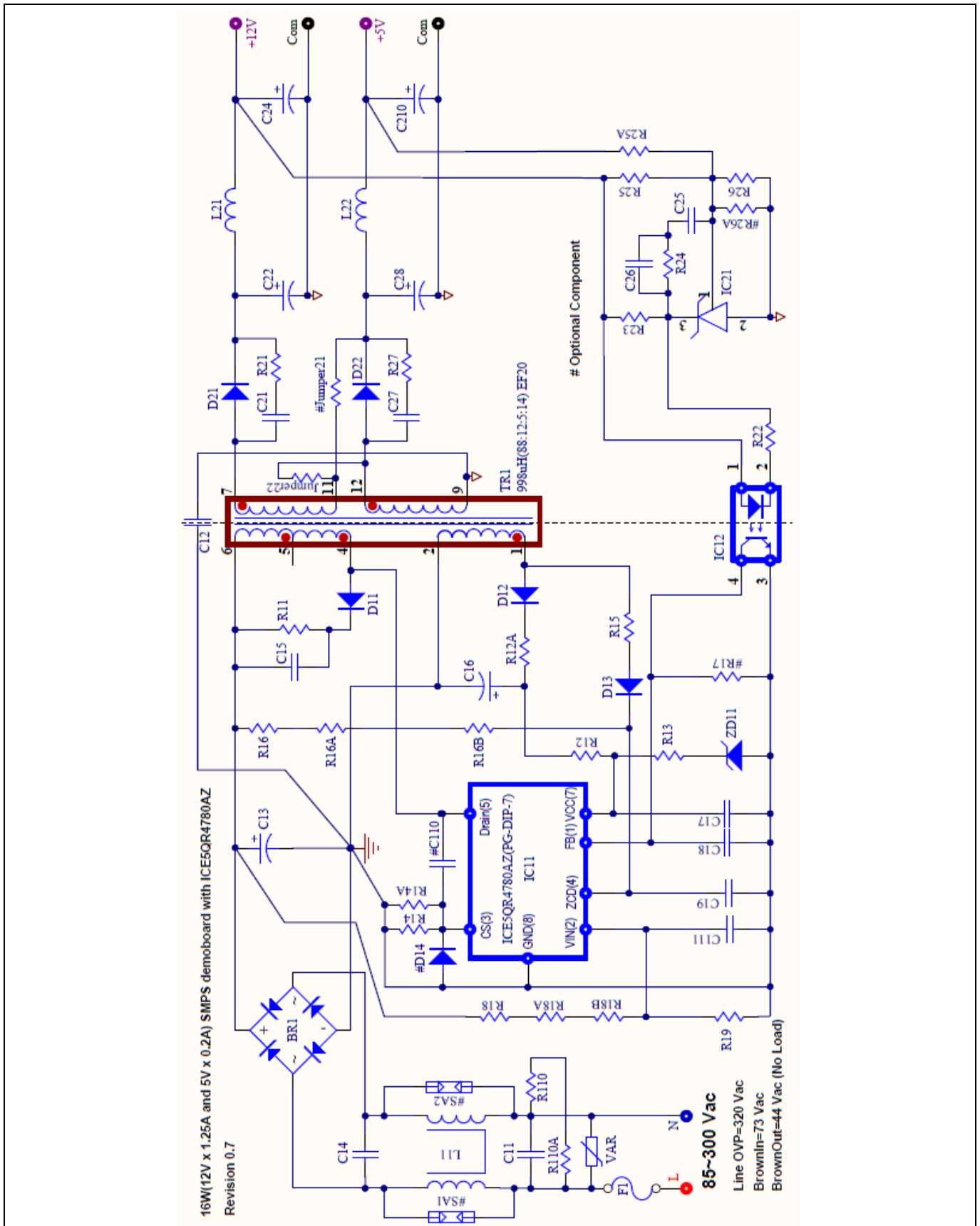

Figure 2 Schematic of DEMO\_5QR4780AZ\_16W1

### Circuit diagram

Note: *General guideline for the layout design of the PCB:*

1. *Star ground at bulk capacitor C13: all primary grounds should be connected to the ground of bulk capacitor C13 separately at one point. This can effectively reduce the switching noise entering the sensitive pins of the CoolSET™ device. The primary star ground can be split into four groups as follows,*
  - i. *Combine signal ground (all small signal grounds connecting to the CoolSET™ GND pin such as filter capacitor ground C17, C18, C19, C111 and optocoupler ground) and power ground (current sense resistor R14 and R14A).*
  - ii. *V<sub>CC</sub> ground includes the V<sub>CC</sub> capacitor ground C16 and the auxiliary winding ground, pin 2 of the power transformer.*
  - iii. *EMI return ground includes Y capacitor C12.*
  - iv. *DC ground from bridge rectifier, BR1*
2. *Filter capacitor close to the controller ground: Filter capacitors, C17, C18, C19 and C111 should be placed as close to the controller ground and the controller pin as possible so as to reduce the switching noise coupled into the controller.*
3. *High voltage traces clearance: High voltage traces should maintain sufficient spacing to the nearby traces. Otherwise, arcing will occur.*
  - i. *400 V traces (positive rail of bulk capacitor C13) to nearby trace: > 2.0 mm*
  - ii. *600V traces (drain voltage of CoolSET™ IC11) to nearby trace: > 2.5 mm*
4. *Recommended minimum 232 mm<sup>2</sup> copper area at drain pin to add on PCB for better thermal performance.*
5. *Power loop area (bulk capacitor C13, primary winding of the transformer TR1 (Pin 4 and 6), IC11 drain pin, IC11 CS pin and current sense resistor R14/R14A) should be as small as possible to minimize the switching emissions.*

PCB layout

# 7 PCB layout

## 7.1 Top side

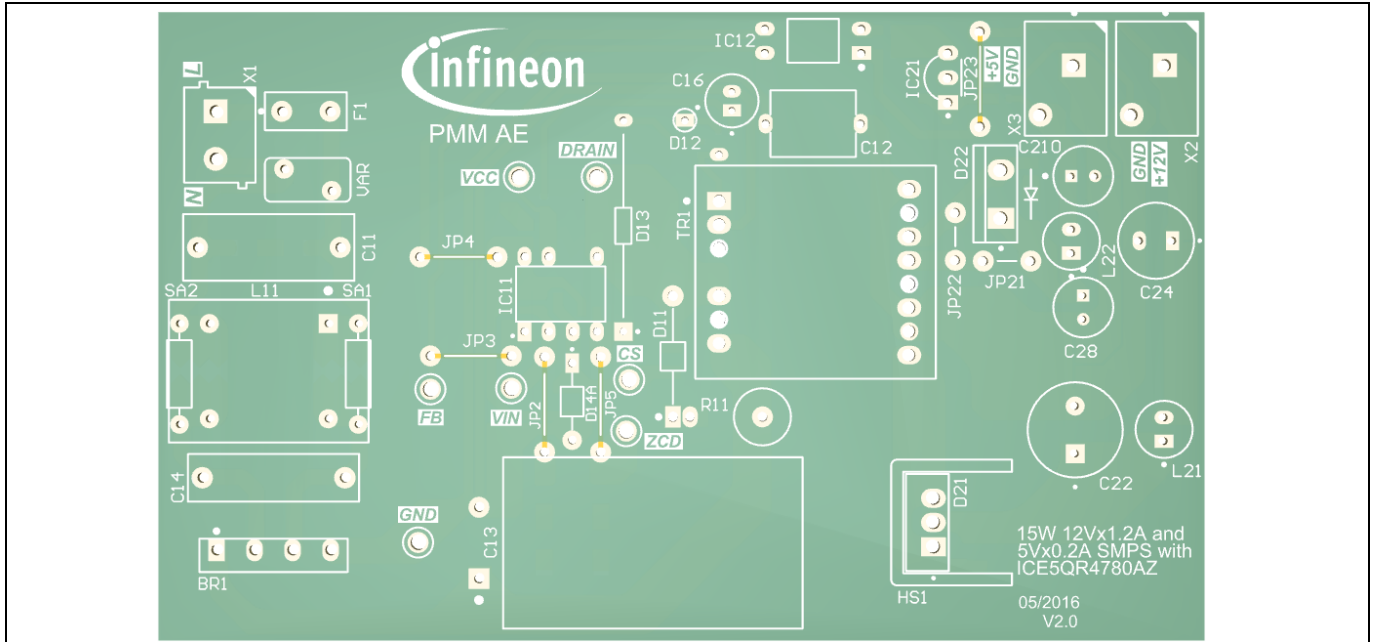

Figure 3 Top side component legend

## 7.2 Bottom side

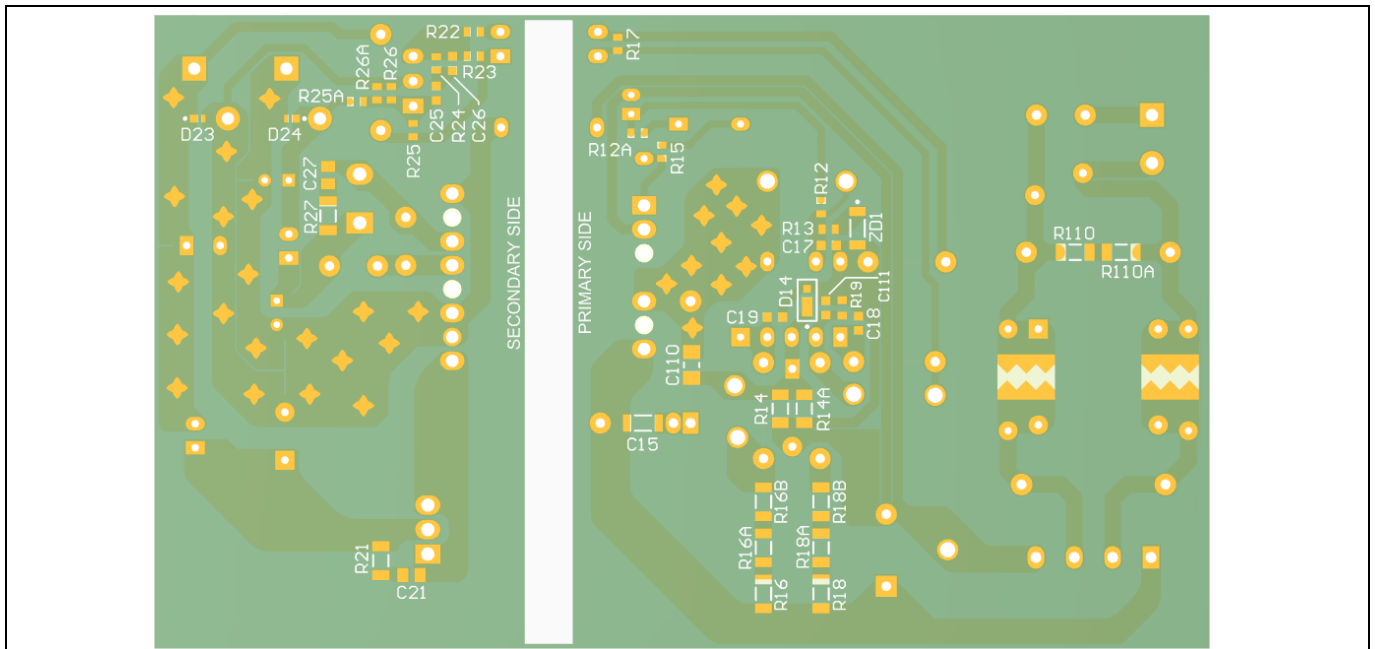

Figure 4 Bottom side copper and component legend

## BOM

## 8 BOM

Table 3 BOM (V0.8)

No.	Designator	Description	Part Number	Manufacturer	Quantity
1	BR1	600 V/1 A	S1VBA60	Shindengen	1
2	C11	0.22 $\mu$ F/305 V	B32922C3224	Epcos	1
3	C12	1 nF/500 V	DE1E3RA102MA4BQ	Murata	1
4	C13	47 $\mu$ F/500 V	500BXC47MEFC18X31.5	Rubycon	1
5	C15	1 nF/1000 V	GRM31BR73A102KW01#	Murata	1
6	C16	22 $\mu$ F/50 V	50PX22MEFC5X11	Rubycon	1
7	C17	100 nF/50 V	GRM188R71H104KA93D	Murata	1
8	C18, C26	1 nF/50 V	GRM1885C1H102GA01D	Murata	2
9	C19	120 pF/50 V	GRM1885C1H121GA01D	Murata	1
10	C111	22 nF/50 V	GCM188R71H223KA37D	Murata	1
11	C21, C27	1 nF/100 V	GRM2162C2A102JA01#	Murata	2
12	C22	1000 $\mu$ F/16 V	16ZLH1000MEFC10X16	Rubycon	1
13	C24	470 $\mu$ F/16 V	16ZLH470MEFC8X11.5	Rubycon	1
14	C25	220 nF/50 V	GRM188R71H224KAC4D	Murata	1
15	C28	330 $\mu$ F/10 V	10ZLH330MEFC6.3X11	Rubycon	1
16	C210	330 $\mu$ F/10 V	10ZLH330MEFC6.3X11	Rubycon	1
17	D11	1 A/800 V	UF4006	1.	1
18	D12	0.2 A/200 V	1N485B	2.	1
19	D13	0.2 A/150 V/50 ns	FDH400	3.	1
20	D21	20 A/100 V	STPS20M100SFP	4.	1
21	D22	10 A/45 V	VFT1045BP	5.	1
22	F1	1.6 A/300 V	36911600000	6.	1
23	HS21	Heatsink	577202B00000G	7.	1
24	IC11	ICE5QR4770AZ	ICE5QR4770AZ	Infineon	1
25	IC12	Optocoupler	SFH617A-3	8.	2
26	IC21	Shunt regulator	TL431BVLPG	9.	1
27	JP2, JP3, JP4, JP5, JP22 and JP23	Jumper	10.	11.	6
28	L11	39 mH/0.7 A	B82732R2701B030	Epcos	1
29	L21	2.2 $\mu$ H/4.3 A	744 746 202 2	Würth Electronics	1
30	L22	4.7 $\mu$ H/4.2 A	744 746 204 7	Würth Electronics	1
31	R11	68 k $\Omega$ /2 W/350 V	ERG-2SJ683A	Panasonic	1
32	R12, R13	27 $\Omega$ (0603)	12.		2
33	R12A	0 $\Omega$ (0603)	13.		1
34	R14	2.2 $\Omega$ / 0.33 W/ $\pm$ 1%	ERJ8BQF2R2V	Panasonic	1
35	R14A	2 $\Omega$ / 0.33 W/ $\pm$ 1%	ERJ8BQF2R0V	Panasonic	1
36	R15	27 k $\Omega$ $\pm$ 1% (0603)	14.		1
37	R16, R16A, R16B	15 M $\Omega$ /0.25 W/5%	RC1206JR-0715ML	15.	3
38	R18, R18A, R18B	3 M $\Omega$ /0.25 W/1%	RC1206FR-073ML	16.	3
39	R19	58.3 k $\Omega$ /0.1 W/0.5%	RT0603DRE0758K3L	17.	1
40	R110, R110A	2 M $\Omega$ /5%/200 V	RC1206JR-072ML	18.	2

# 16 W 12 V 5 V SMPS demo board with ICE5QR4780AZ

## AN-DEMO\_5QR4780AZ\_16W1



### BOM

41	R21	51 $\Omega$ / 0.25 W/ $\pm 1\%$	ERJ8ENF51R0V	Panasonic	1
42	R22	820 $\Omega$ (0603)	19.		1
43	R23	1.2 k $\Omega$ (0603)	20.		1
44	R24	12 k $\Omega$ (0603)	21.		1
45	R25	16 k $\Omega$ (0603)	22.		1
46	R25A	6.2 k $\Omega$ (0603)	23.		1
47	R26	2.5 k $\Omega$ (0603)	24.		1
48	R27	13 $\Omega$ / 0.25 W/ $\pm 1\%$	ERJ8ENF13R0V	Panasonic	1
49	TR1	998 $\mu$ H	750343074(Rev 0.2)	Würth Electronics	1
50	Test point of FB, VIN, CS, ZCD, Drain, V <sub>cc</sub> , Gnd	Test point	5010	25.	7
51	VAR	0.3 W/320 V	ERZE07A511	Panasonic	1
52	ZD1	22 V Zener	26.		1
53	Con(L N)	Connector	691102710002	Würth Electronics	1
54	Con(+12 V Com), Con(+5 V Com)	Connector	691 412 120 002B	Würth Electronics	2

# 16 W 12 V 5 V SMPS demo board with ICE5QR4780AZ

## AN-DEMO\_5QR4780AZ\_16W1

### Transformer construction

## 9 Transformer construction

Core and material: EE20/10/6(EF20), TP4A (TDG)

Bobbin: 070-5643 (14 Pin, THT, horizontal version)

Primary inductance:  $L_p=998 \mu\text{H}$  ( $\pm 10\%$ ), measured between pin 4 and pin 6

Manufacturer and part number: Würth Electronics Midcom (750343074)

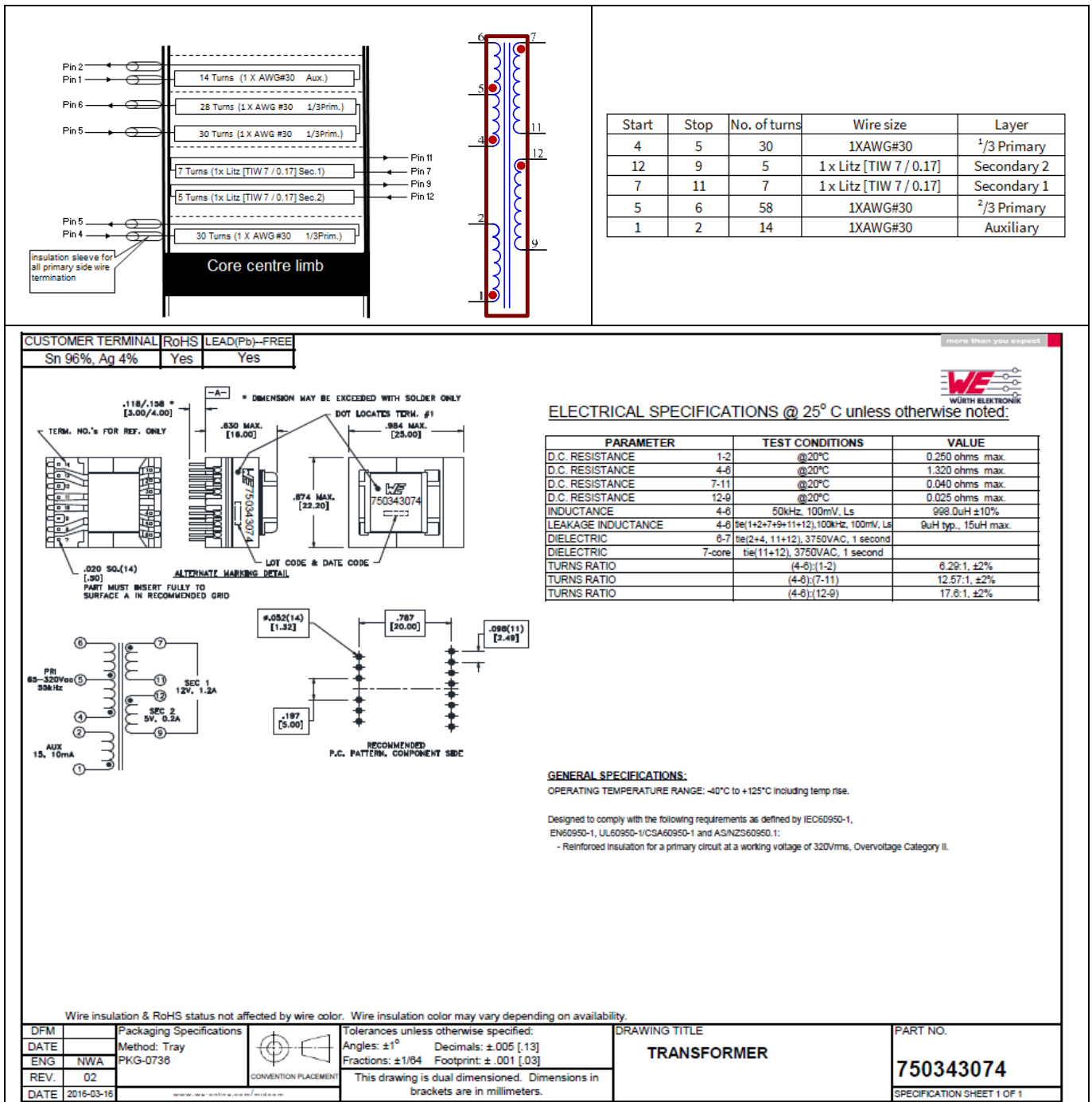

Figure 5 Transformer structure

Test results

## 10 Test results

### 10.1 Efficiency, regulation and output ripple

Table 4 Efficiency, regulation & output ripple

Input (V AC/Hz)	P <sub>in</sub> (W)	V <sub>out1</sub> (V DC)	I <sub>out1</sub> (A)	V <sub>ORPP1</sub> (mV)	V <sub>out2</sub> (V DC)	I <sub>out2</sub> (A)	V <sub>ORPP2</sub> (mV)	P <sub>out</sub> (W)	Efficiency η (%)	Average η (%)	OLP P <sub>in</sub> (W)	OLP I <sub>out2</sub> (Fixed 5 V at 0.2 A) (A)
85 V AC/ 60Hz	0.04156	4.90	0.00	20	12.17	0.00	36	/	/	/	25.12	1.55
	0.07992	4.76	0.006	56	12.52	0.00	18	0.03	35.74	/		
	9.01	4.93	0.06	19	12.11	0.60	20	7.56	83.93	83.03		
	4.67	4.90	0.05	15	12.17	0.30	15	3.90	83.43			
	9.27	4.91	0.10	19	12.16	0.60	18	7.79	84.00			
	14.09	4.90	0.15	22	12.18	0.90	19	11.70	83.02			
	19.84	4.90	0.20	25	12.18	1.25	24	16.21	81.68			
115 V AC/ 60Hz	0.04650	4.90	0.00	21	12.16	0.00	39	/	/	/	28.00	1.82
	0.08458	4.76	0.006	58	12.52	0.00	17	0.03	33.77	/		
	8.89	4.93	0.06	19	12.09	0.60	19	7.55	84.92	84.67		
	4.64	4.90	0.05	16	12.17	0.30	16	3.90	83.97			
	9.16	4.91	0.10	19	12.15	0.60	18	7.78	84.95			
	13.76	4.91	0.15	21	12.16	0.90	20	11.68	84.89			
	19.06	4.91	0.20	23	12.16	1.25	20	16.18	84.90			
230 V AC/ 50Hz	0.07107	4.90	0.00	22	12.17	0.00	38	/	/	/	28.40	1.90
	0.11151	4.75	0.006	59	12.54	0.00	18	0.03	25.56	/		
	8.94	4.93	0.06	20	12.09	0.60	19	7.55	84.45	84.05		
	4.78	4.90	0.05	18	12.16	0.30	17	3.89	81.44			
	9.22	4.91	0.10	21	12.15	0.60	19	7.78	84.39			
	13.71	4.93	0.15	21	12.12	0.90	20	11.65	84.96			
	18.92	4.92	0.20	23	12.14	1.25	21	16.16	85.41			
265 V AC/ 50Hz	0.08232	4.89	0.00	21	12.19	0.00	40	/	/	/	29.20	1.96
	0.12324	4.75	0.006	57	12.56	0.00	17	0.03	23.13	/		
	9.02	4.94	0.06	20	12.08	0.60	19	7.54	83.64	83.30		
	4.87	4.90	0.05	16	12.17	0.30	16	3.90	80.00			
	9.28	4.91	0.10	21	12.15	0.60	19	7.78	83.85			
	13.83	4.93	0.15	21	12.12	0.90	19	11.65	84.22			
	18.97	4.92	0.20	24	12.13	1.25	22	16.15	85.12			
300 V AC/ 50Hz	0.09631	4.89	0.00	22	12.18	0.00	39	/	/	/	30.13	2.03
	0.14497	4.76	0.006	56	12.54	0.00	17	0.03	19.70	/		
	9.12	4.94	0.06	20	12.08	0.60	19	7.54	82.72	82.48		
	4.96	4.90	0.05	15	12.18	0.30	14	3.90	78.61			
	9.39	4.91	0.10	21	12.15	0.60	19	7.78	82.86			
	13.91	4.92	0.15	22	12.13	0.90	21	11.66	83.79			
	19.06	4.93	0.20	25	12.12	1.25	23	16.14	84.66			

Minimum load condition : 5 V at 6 mA

Typical load condition : 5 V at 60 mA and 12 V at 0.6 A

Maximum load condition : 5 V at 200 mA and 12 V at 1.25 A

Test results

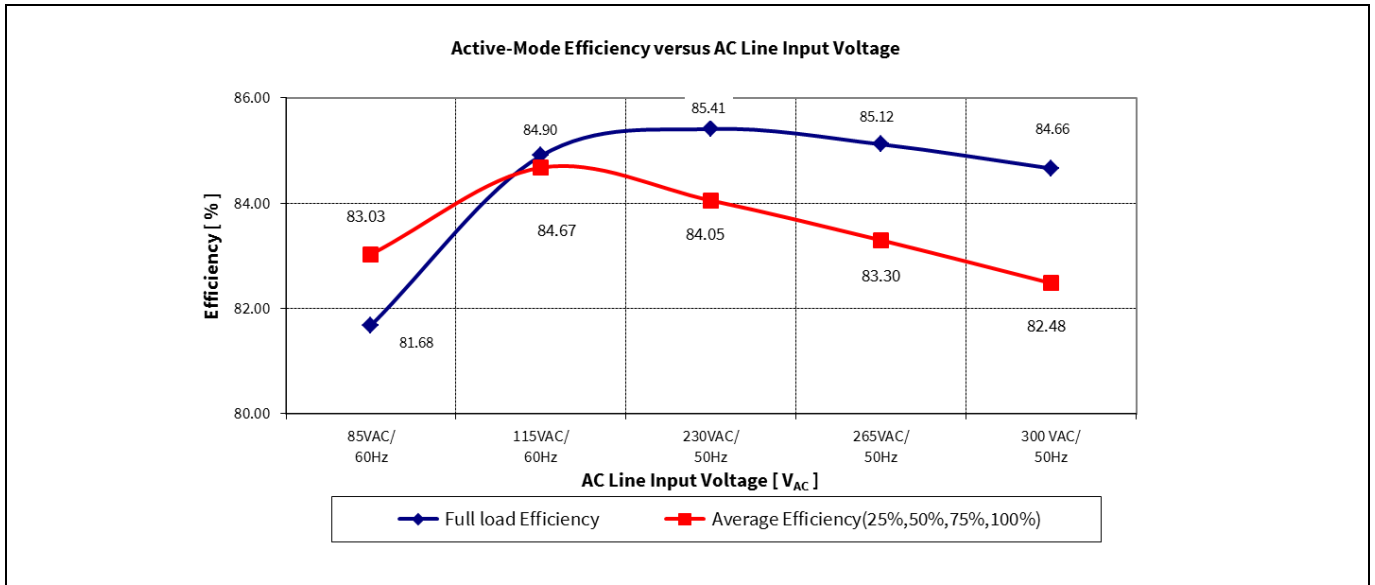

Figure 6 Efficiency vs. AC line input voltage

### 10.2 Standby power

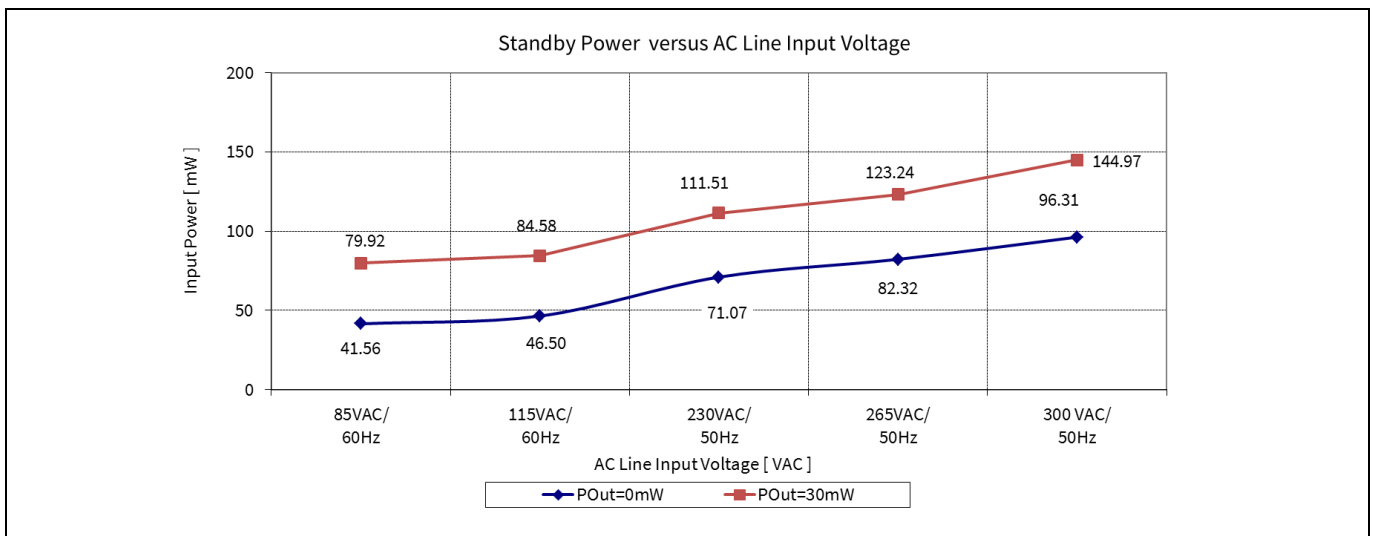

Figure 7 Standby power at no load and 30 mW load vs. AC line input voltage (measured by Yokogawa WT210 power meter - integration mode)



Test results

### 10.3 Line regulation

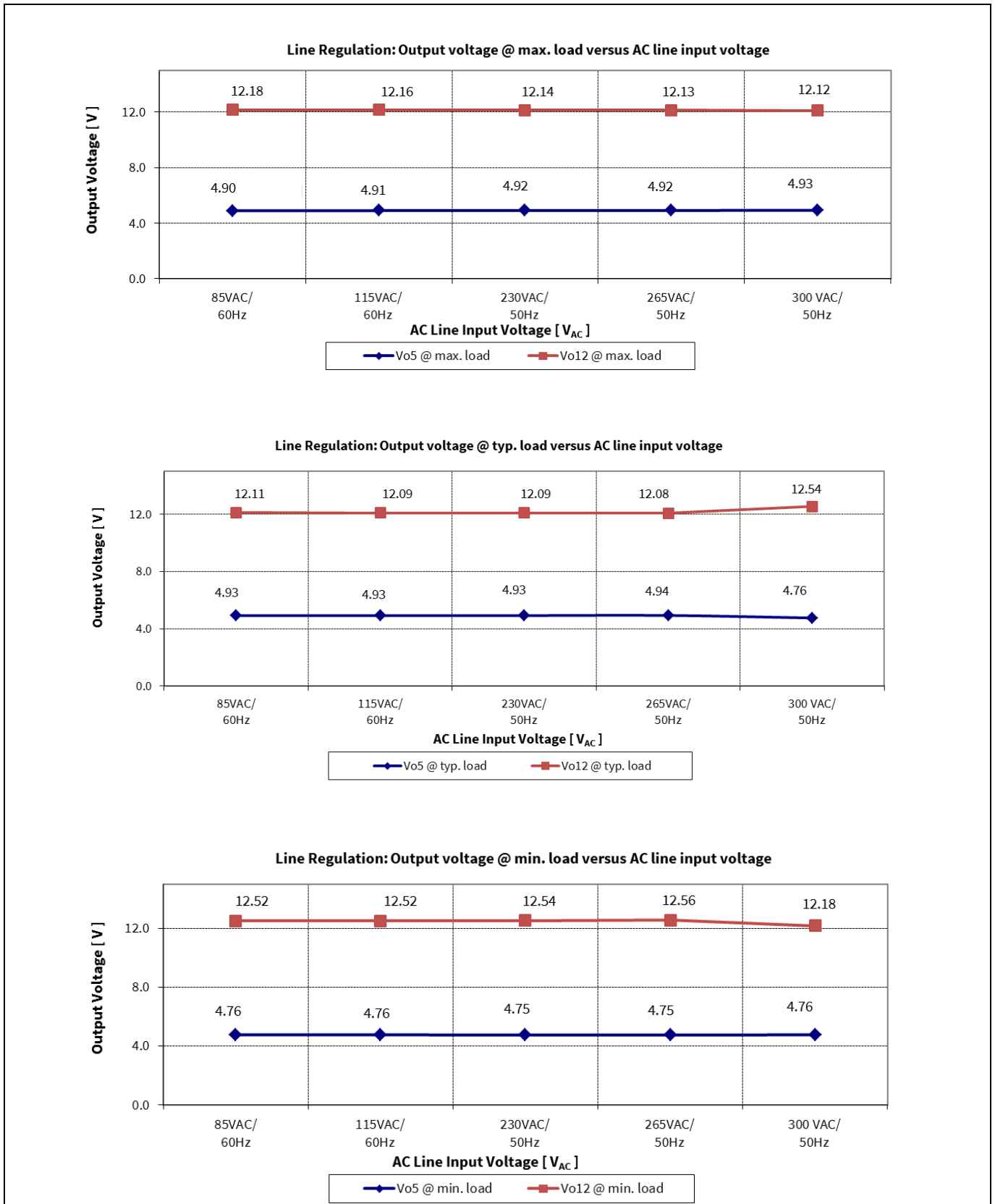

Figure 8 Line regulation V<sub>out</sub> at full load vs. AC line input voltage

Test results

10.4 Load regulation

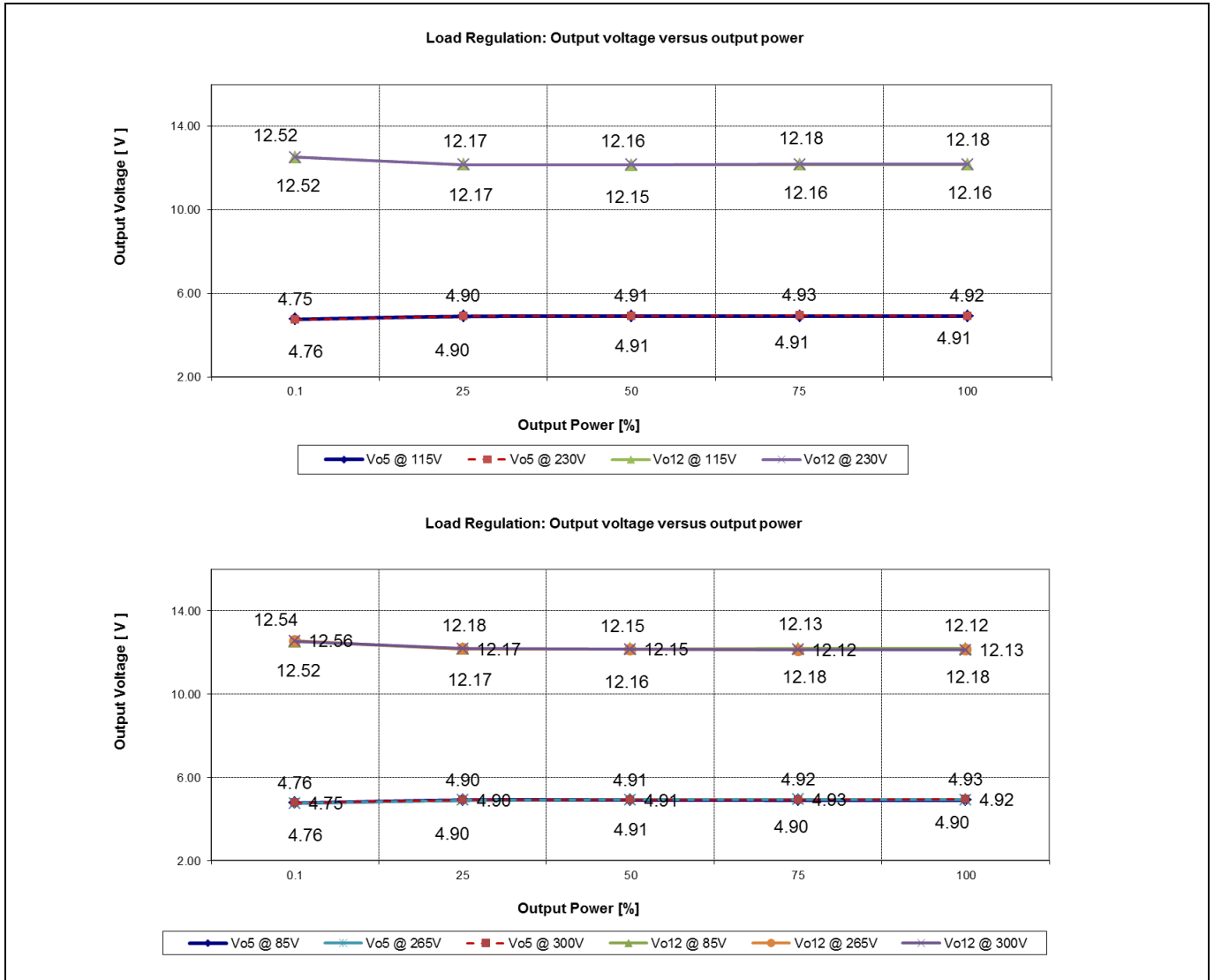

Figure 9 Load regulation  $V_{out}$  vs. output power

Test results

10.5 Maximum input power

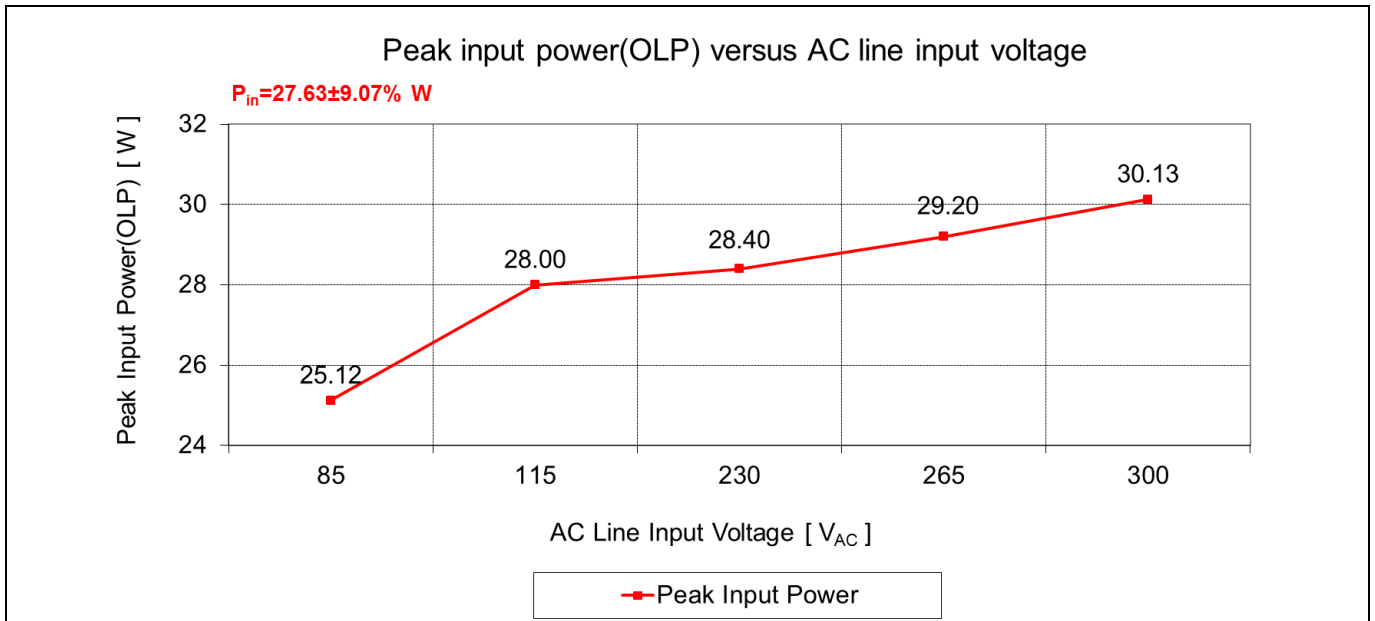

Figure 10 Maximum input power (before overload protection) vs. AC line input voltage

10.6 ESD immunity (EN61000-4-2)

Pass EN61000-4-2 Special Level ( $\pm 14 \text{ kV}$  for contact discharge and  $\pm 16 \text{ kV}$  air discharge).

10.7 Surge immunity (EN61000-4-5)

Pass EN61000-4-5 Installation class 4 ( $\pm 2 \text{ kV}$  for line to line and  $\pm 4 \text{ kV}$  for line to earth)<sup>1</sup>.

10.8 Conducted emissions (EN55022 class B)

The conducted EMI was measured with a Schaffner (SMR4503) in accordance with the test standard of EN55022 (CISPR 22) class B. The demo board was set up at maximum load (16 W) with input voltage of 115 V AC and 230 V AC.

<sup>1</sup> PCB spark gap distance needs to reduce to 0.5 mm and C13 change to 120  $\mu\text{F}$ .

Test results

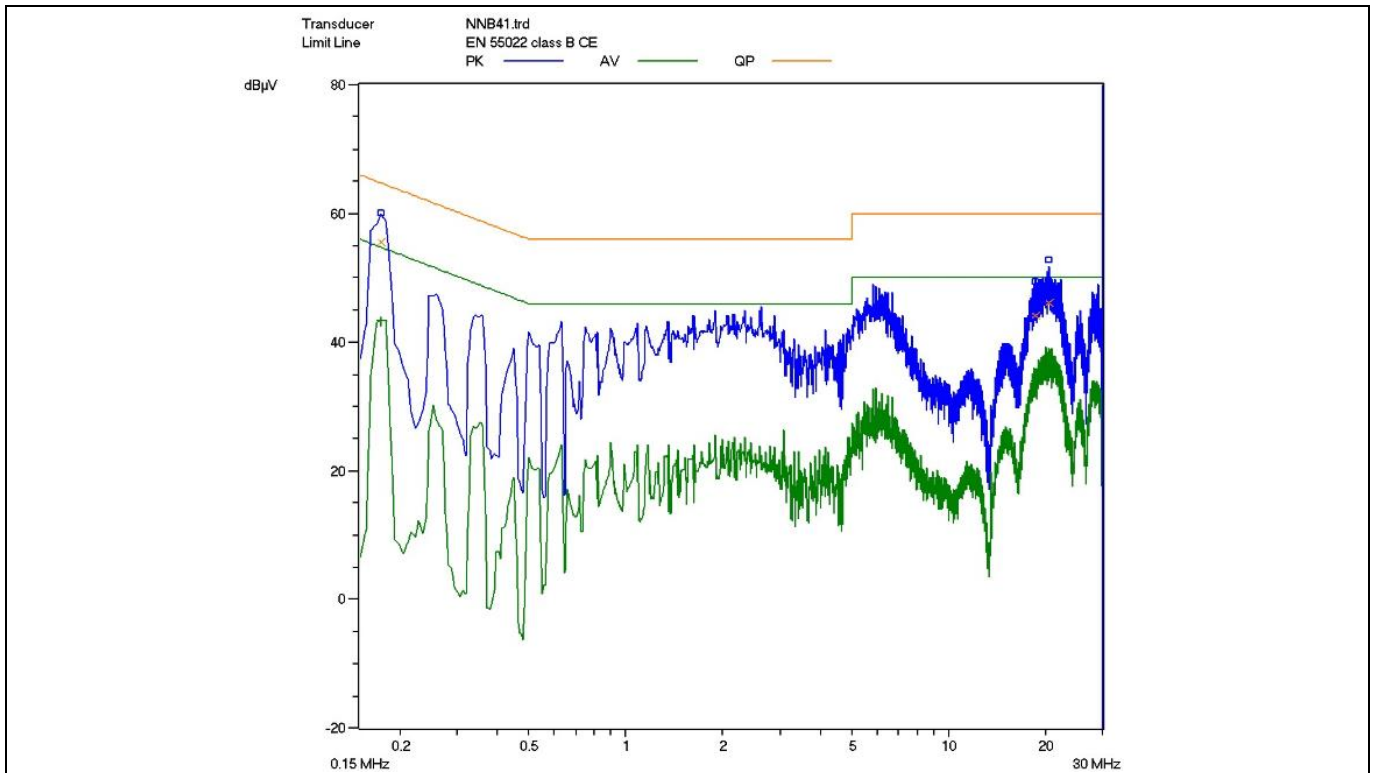

Figure 11 Conducted emissions (line) at 115 V AC and maximum load

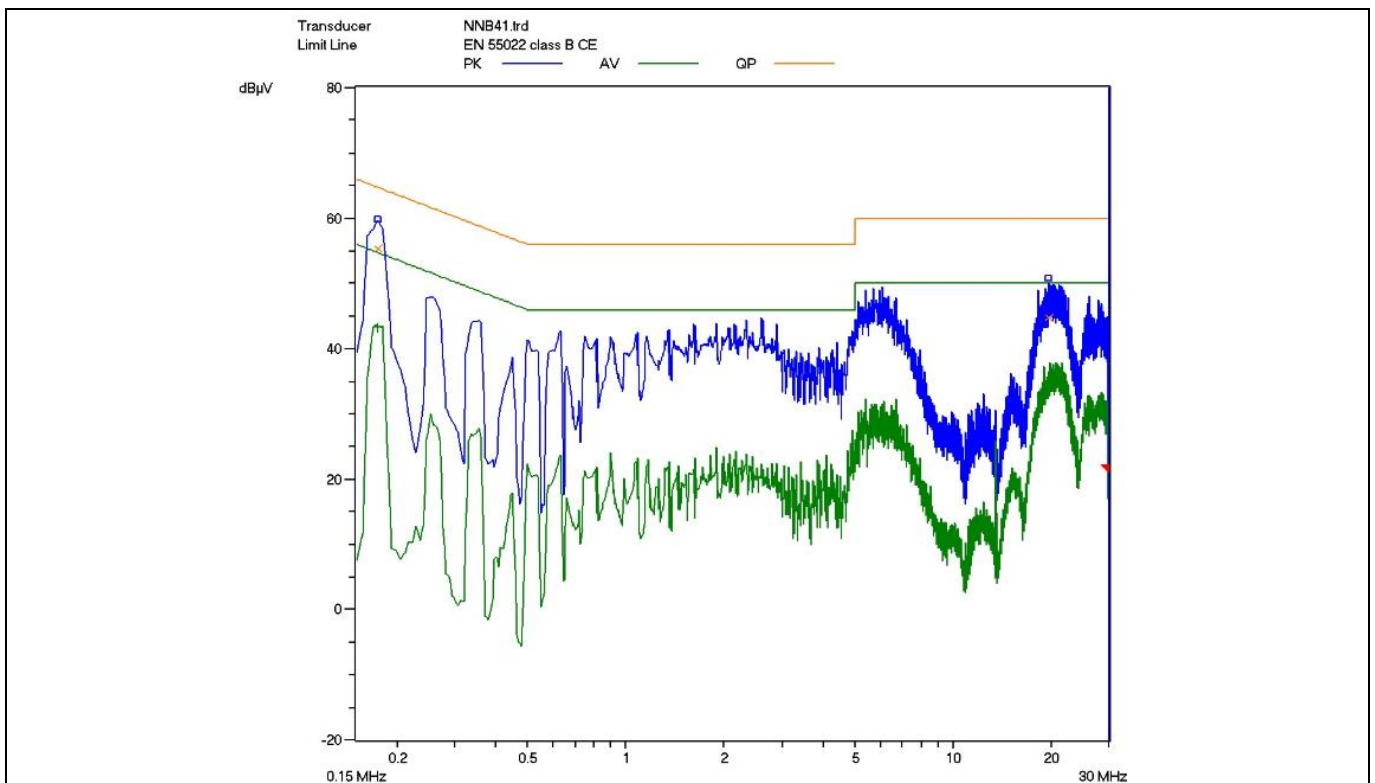

Figure 12 Conducted emissions (neutral) at 115 V AC and maximum load

Pass conducted emissions EN55022 (CISPR 22) class B with 8 dB margin for quasi-peak measurement at low line (115 V AC).

Test results

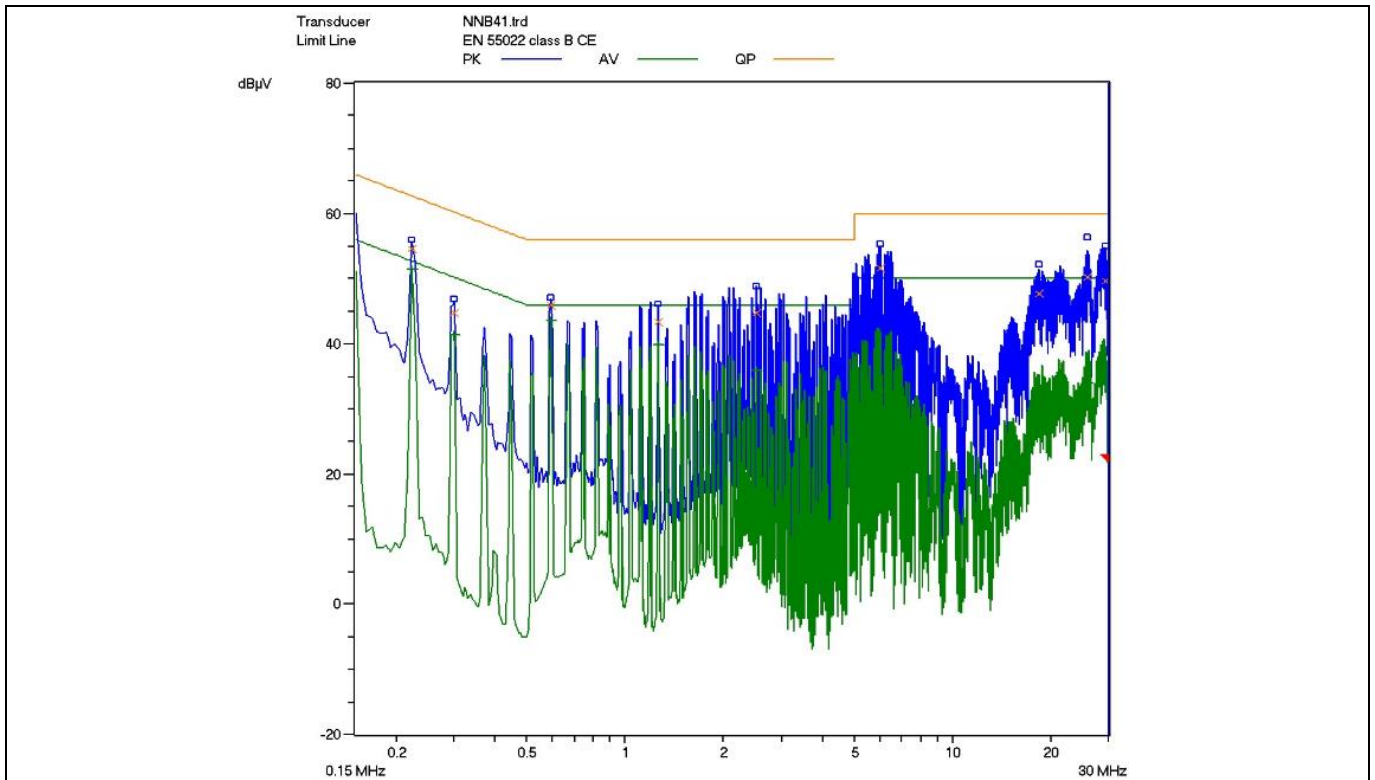

Figure 13 Conducted emissions(line) at 230 V AC and maximum load

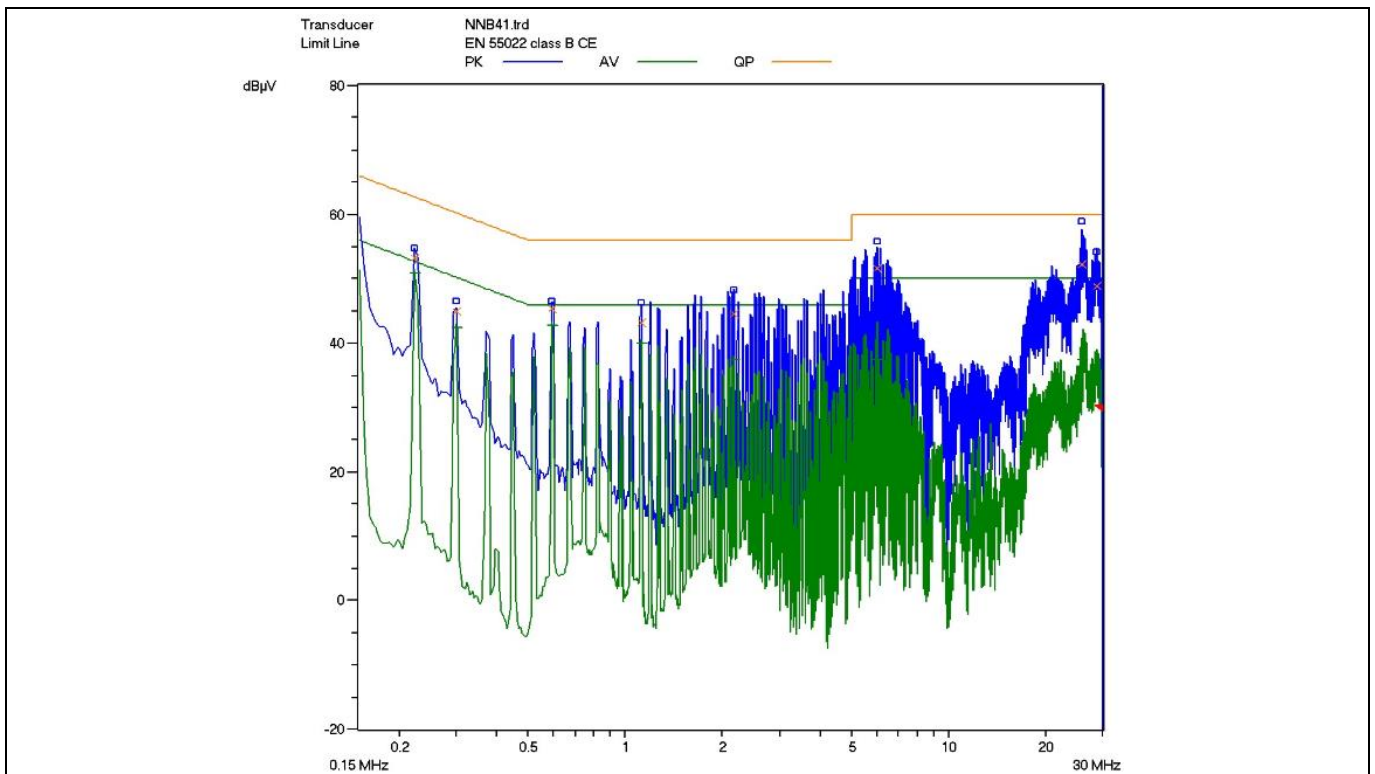

Figure 14 Conducted emissions (neutral) at 230 V AC and maximum load

Pass conducted emissions EN55022 (CISPR 22) class B with 6 dB margin for quasi-peak measurement at high line (230 V AC).

Test results

### 10.9 Thermal measurement

The thermal test of an open frame demo board was performed using an infrared thermography camera (TVS-500EX) at an ambient temperature of 25°C. The measurements were taken after one hour running at full load.

**Table 5 Hottest temperature of demo board**

No.	Major component	85 V AC (°C)	300 V AC (°C)
1	IC11 (ICE5QR4780AZ)	75.0	49.2
2	R14A (current sense resistor)	56.0	42.0
3	TR1 (transformer)	54.3	64.6
4	BR1 (bridge diode)	47.0	32.0
5	R11(clamper resistor)	57.5	52.6
6	L11 (choke)	48.8	30.4
7	D21 (Secondary diode)	47.5	52.2
8	D22 (Secondary diode)	37.5	43.6
9	Ambient	25.0	25.0

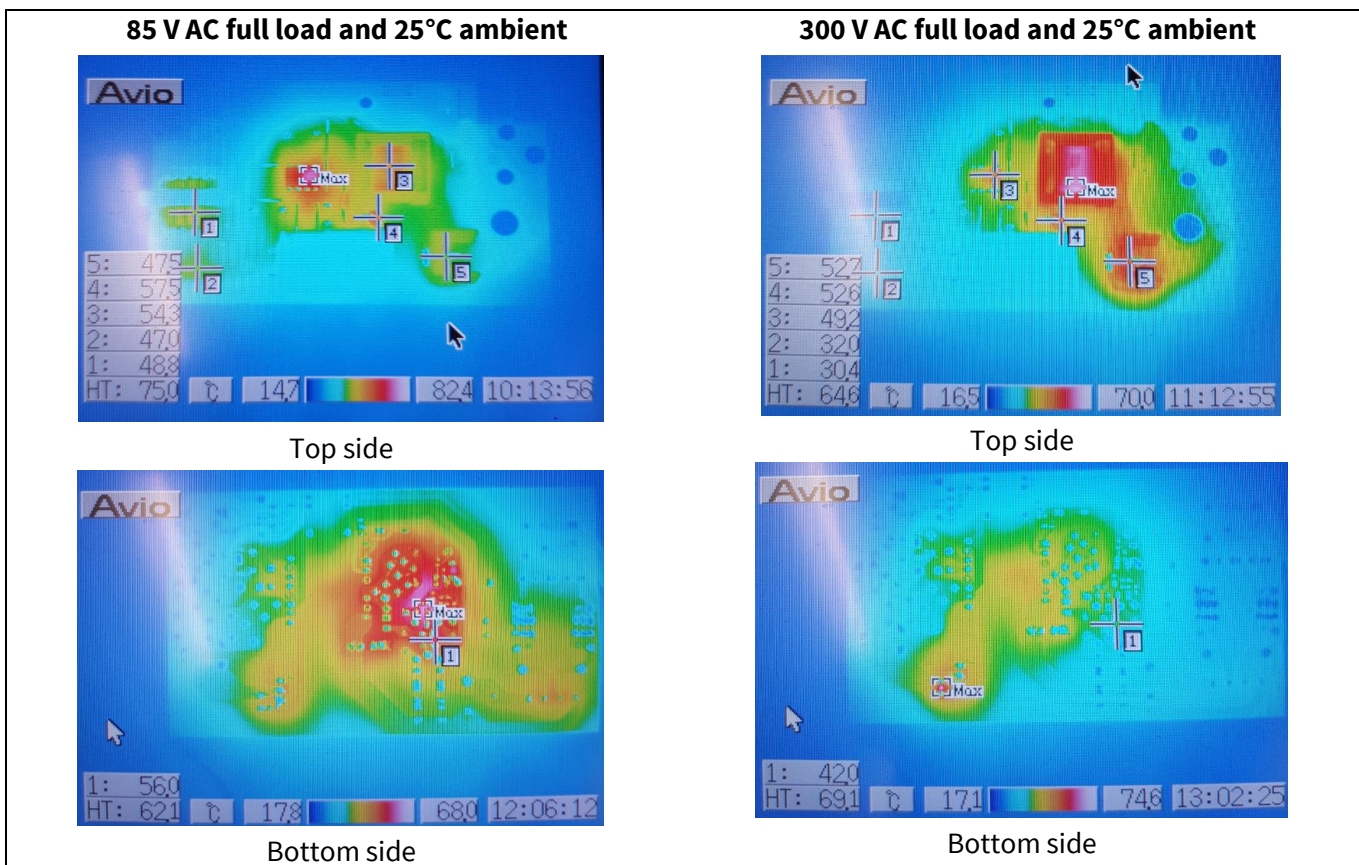

**Figure 15 Infrared thermal image of DEMO\_5QR4780AZ\_16W1**

# 16 W 12 V 5 V SMPS demo board with ICE5QR4780AZ

## AN-DEMO\_5QR4780AZ\_16W1

### Waveforms and scope plots

## 11 Waveforms and scope plots

All waveforms and scope plots were recorded with a TELEDYNE LEICROY 606Zi oscilloscope.

### 11.1 Startup at low/high AC line input voltage with maximum load

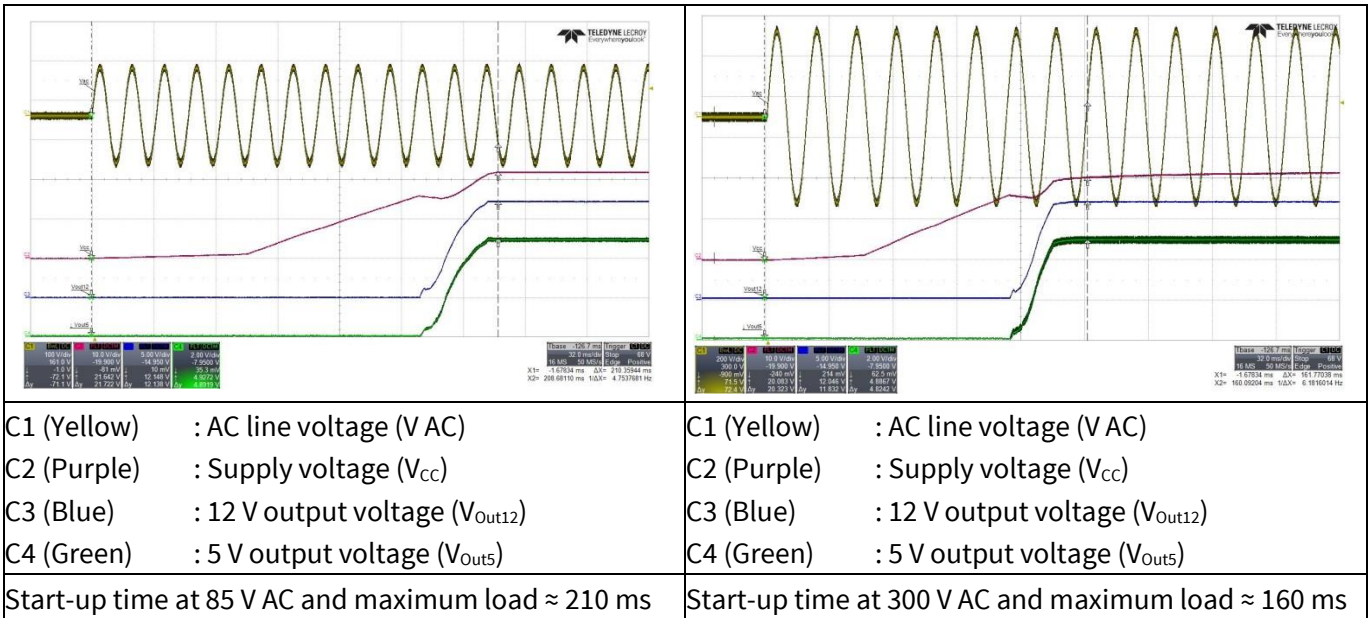

Figure 16 Start-up

### 11.2 Soft start

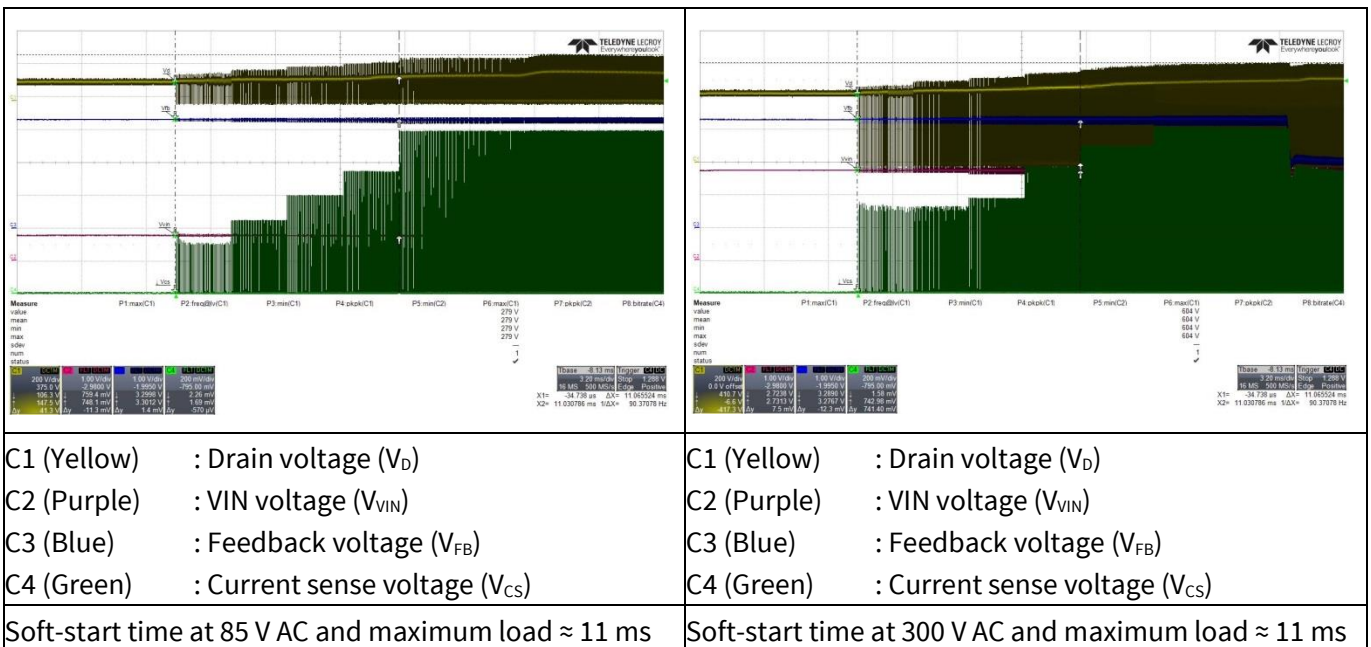

Figure 17 Soft start

Waveforms and scope plots

11.3 Drain and current sense voltage at maximum load

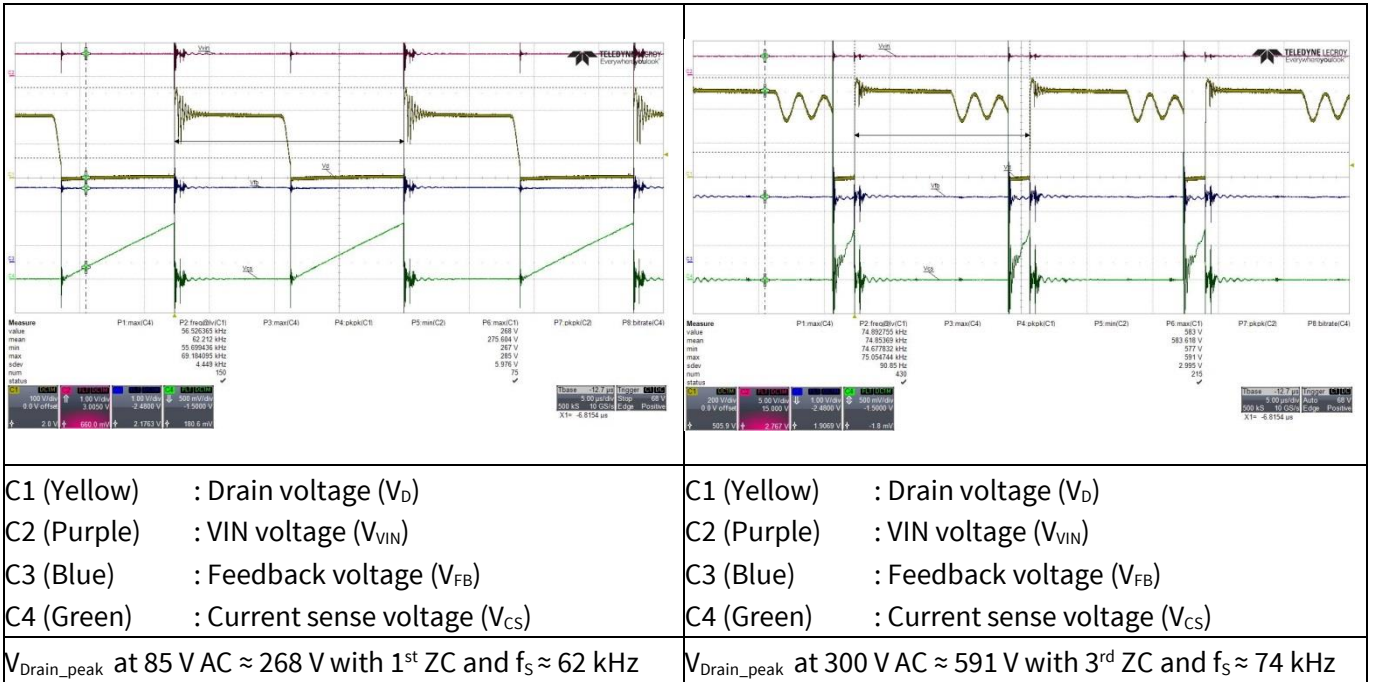

Figure 18 Drain and current sense voltage at maximum load

11.4 Zero crossing point during normal operation

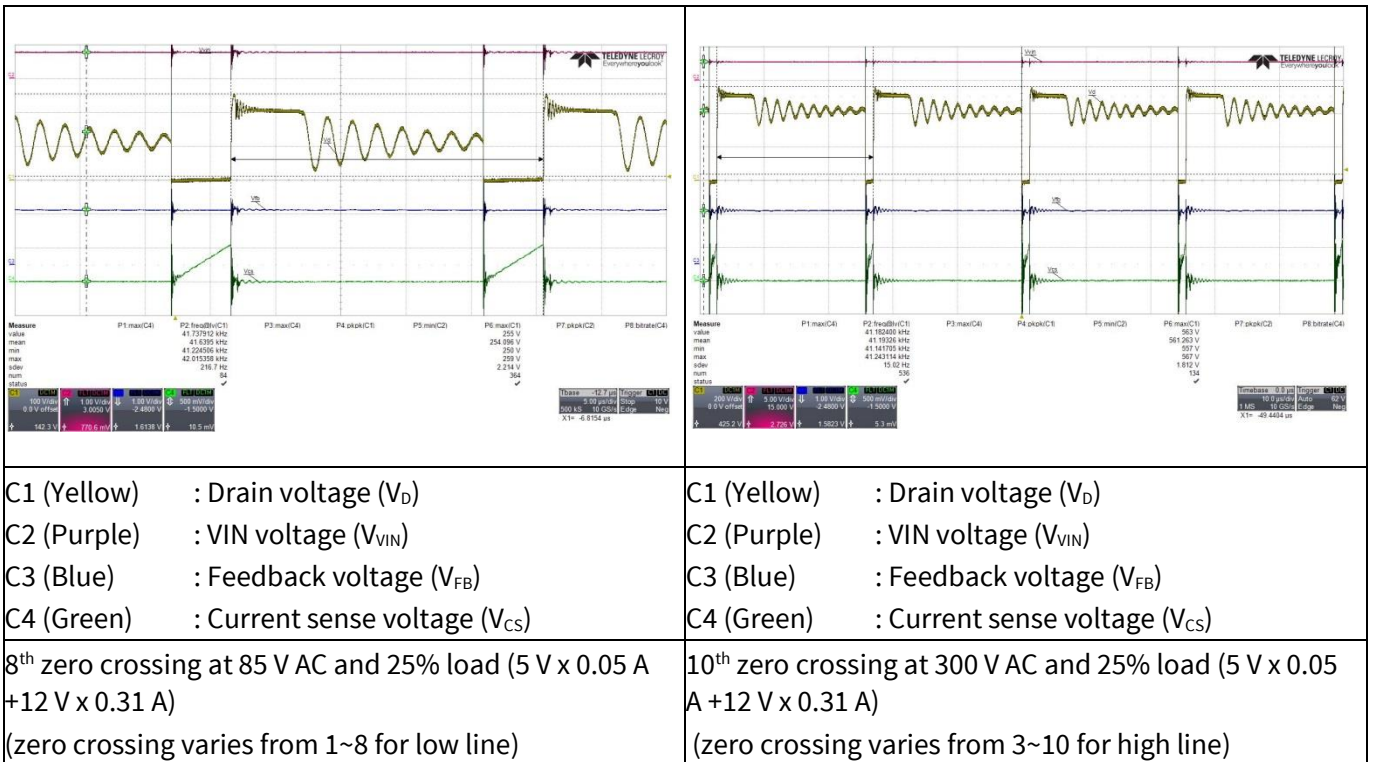

Figure 19 Zero crossing



Waveforms and scope plots

11.5 Load transient response (dynamic load from 10% to 100%)

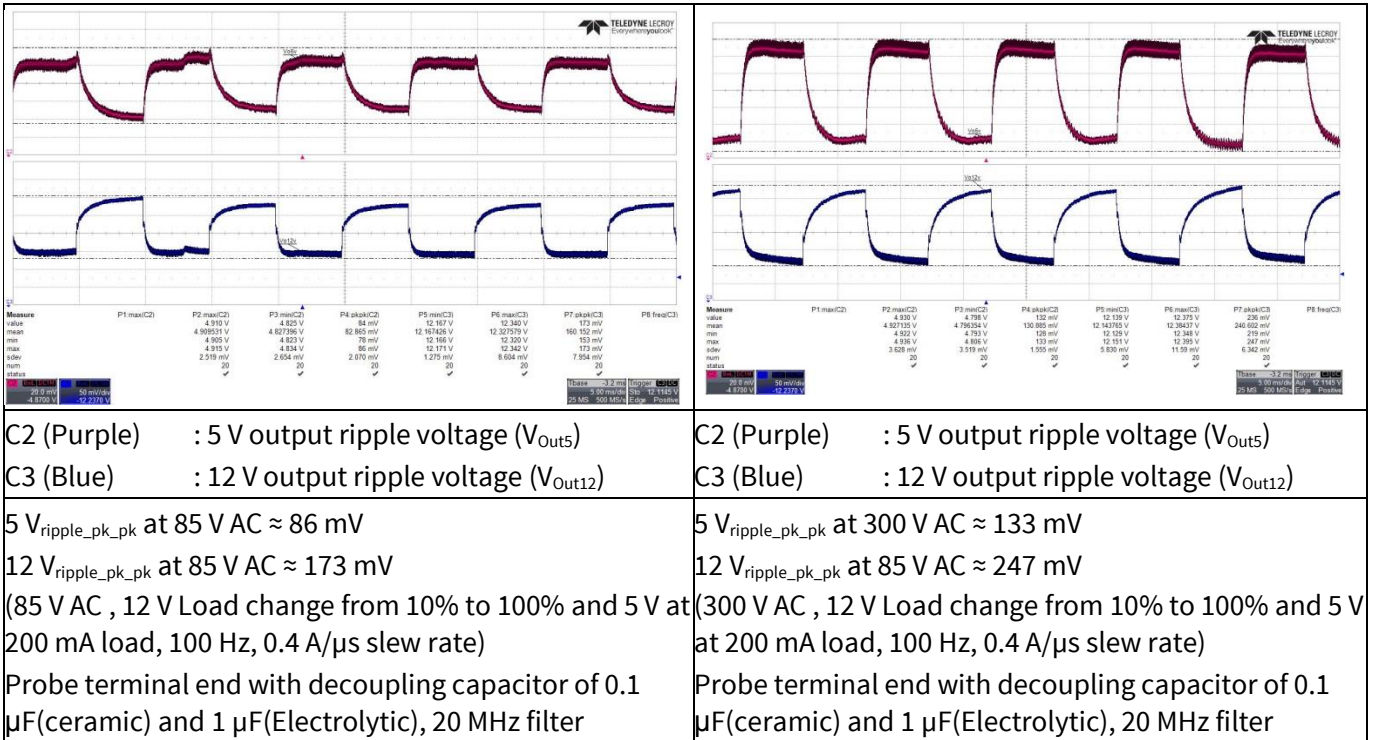

Figure 20 Load transient response

11.6 Output ripple voltage at maximum load

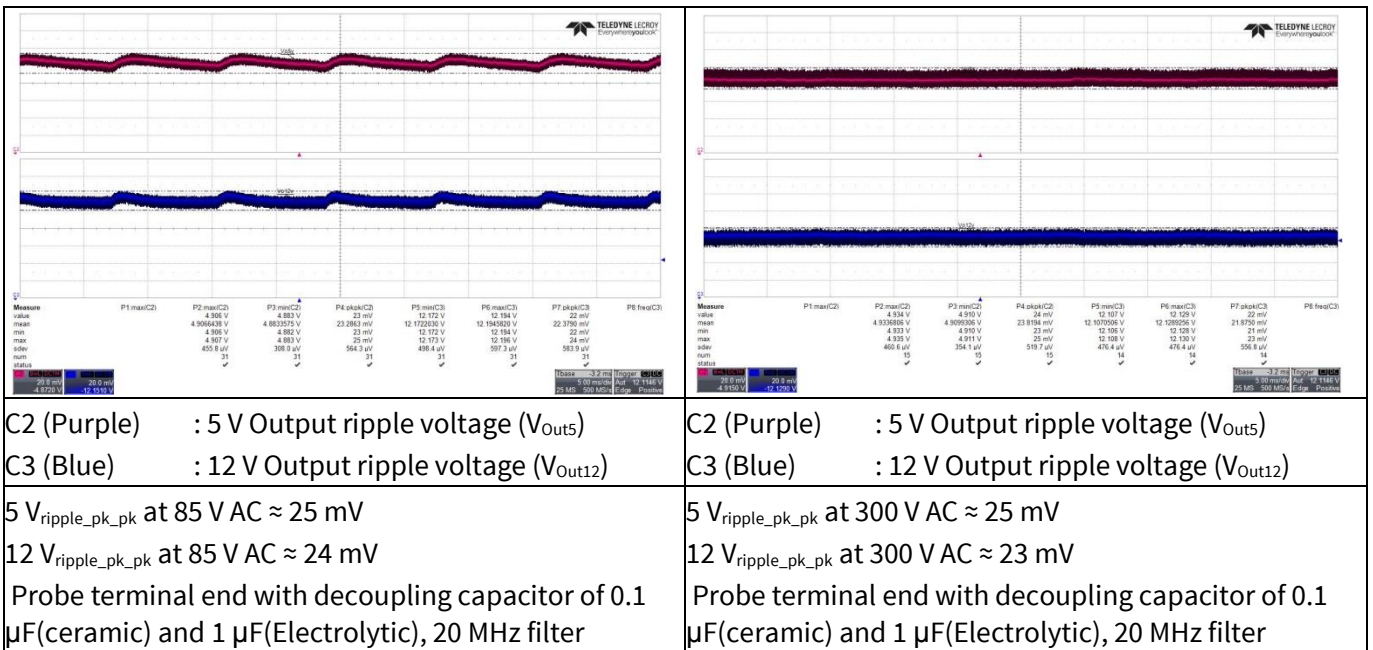
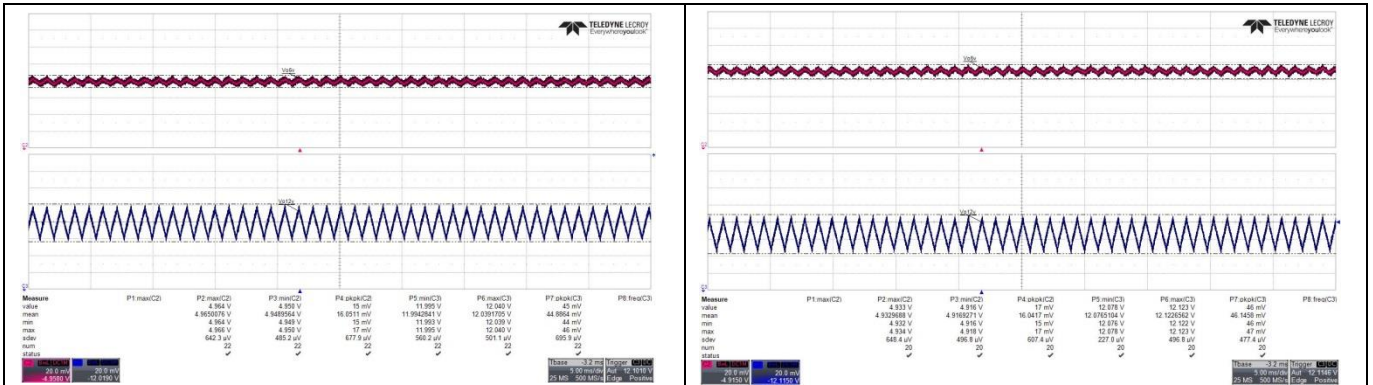

Figure 21 Output ripple voltage at maximum load

Waveforms and scope plots

11.7 Output ripple voltage in active burst mode 1 W load



C2 (Purple) : 5 V Output ripple voltage ( $V_{Out5}$ )  
 C3 (Blue) : 12 V Output ripple voltage ( $V_{Out12}$ )

5 V<sub>ripple\_pk\_pk</sub> at 85 V AC  $\approx$  17 mV  
 12 V<sub>ripple\_pk\_pk</sub> at 85 V AC  $\approx$  46 mV  
 Load: 5 V at 6 mA and 12 V at 80 mA  
 Probe terminal end with decoupling capacitor of 0.1  $\mu$ F(ceramic) and 1  $\mu$ F(Electrolytic), 20 MHz filter

C2 (Purple) : 5 V Output ripple voltage ( $V_{Out5}$ )  
 C3 (Blue) : 12 V Output ripple voltage ( $V_{Out12}$ )

5 V<sub>ripple\_pk\_pk</sub> at 300 V AC  $\approx$  17 mV  
 12 V<sub>ripple\_pk\_pk</sub> at 300 V AC  $\approx$  47 mV  
 Load: 5 V at 6 mA and 12 V at 80 mA  
 Probe terminal end with decoupling capacitor of 0.1  $\mu$ F(ceramic) and 1  $\mu$ F(Electrolytic), 20 MHz filter

Figure 22 Output ripple voltage at burst mode 1 W load

11.8 Entering active burst mode

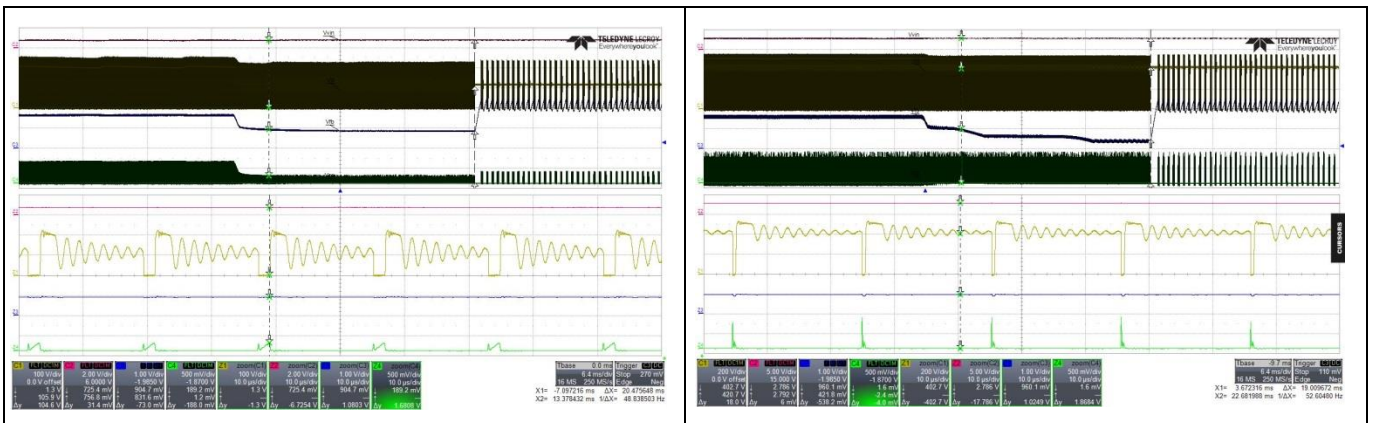

C1 (Yellow) : Drain voltage ( $V_D$ )  
 C2 (Purple) : VIN voltage ( $V_{VIN}$ )  
 C3 (Blue) : Feedback voltage ( $V_{FB}$ )  
 C4 (Green) : Current sense voltage ( $V_{CS}$ )

Condition to enter burst mode level 1 :  $V_{FB} < 0.9$  V,  $N_{ZC} = 8$  and  $t_{blanking} = 20$  ms  
 (load change form 5 W to 0.5 W at 85 V AC)

C1 (Yellow) : Drain voltage ( $V_D$ )  
 C2 (Purple) : VIN voltage ( $V_{VIN}$ )  
 C3 (Blue) : Feedback voltage ( $V_{FB}$ )  
 C4 (Green) : Current sense voltage ( $V_{CS}$ )

Condition to enter burst mode level 1 :  $V_{FB} < 0.9$  V,  $N_{ZC} = 10$  and  $t_{blanking} = 20$  ms  
 (load change form 5 W to 0.5 W at 300 V AC)

Figure 23 Entering active burst mode

Waveforms and scope plots

11.9 During active burst mode

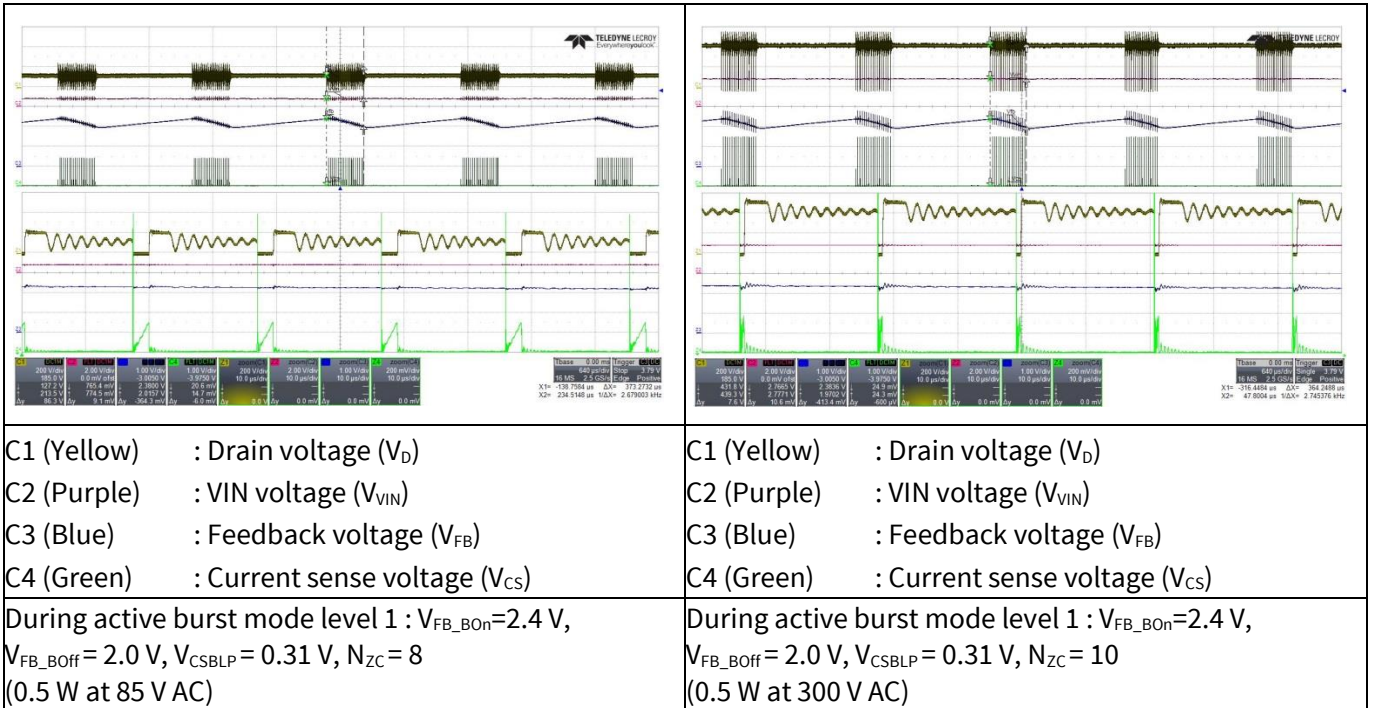

Figure 24 During active burst mode

11.10 Leaving active burst mode

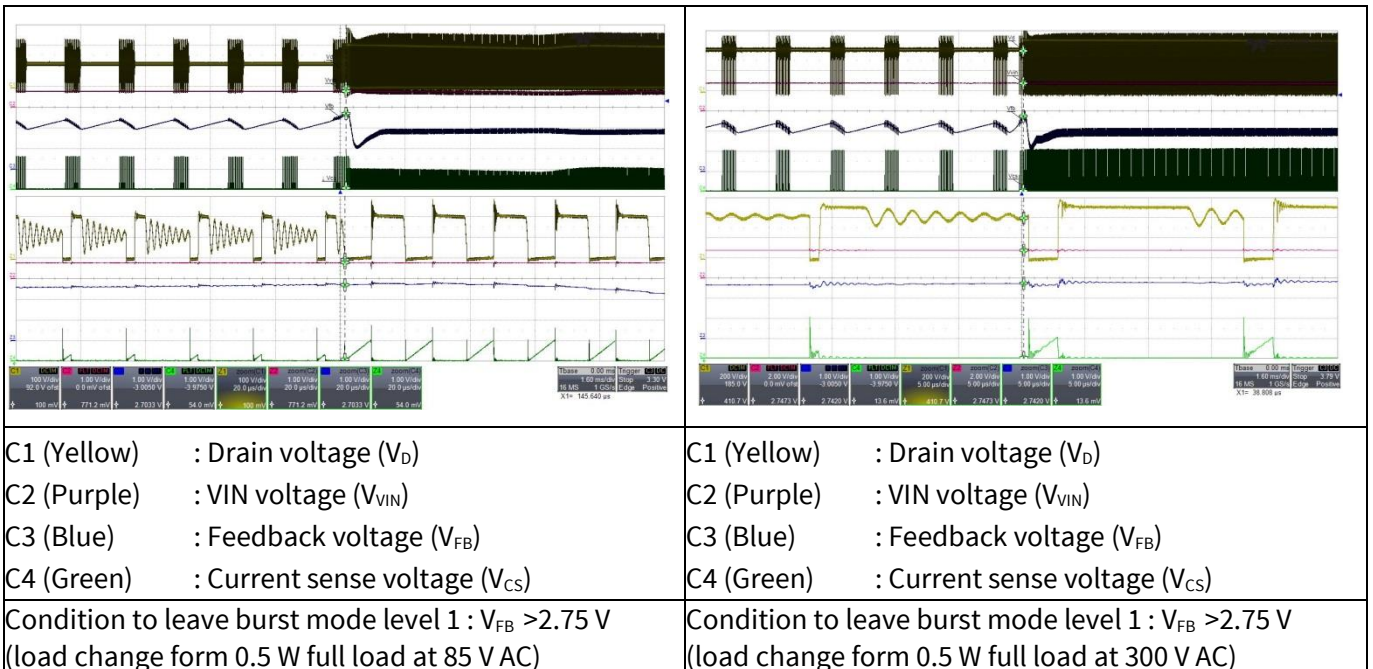

Figure 25 Leaving active burst mode

Waveforms and scope plots

11.11 Line over voltage protection (non switch auto restart)

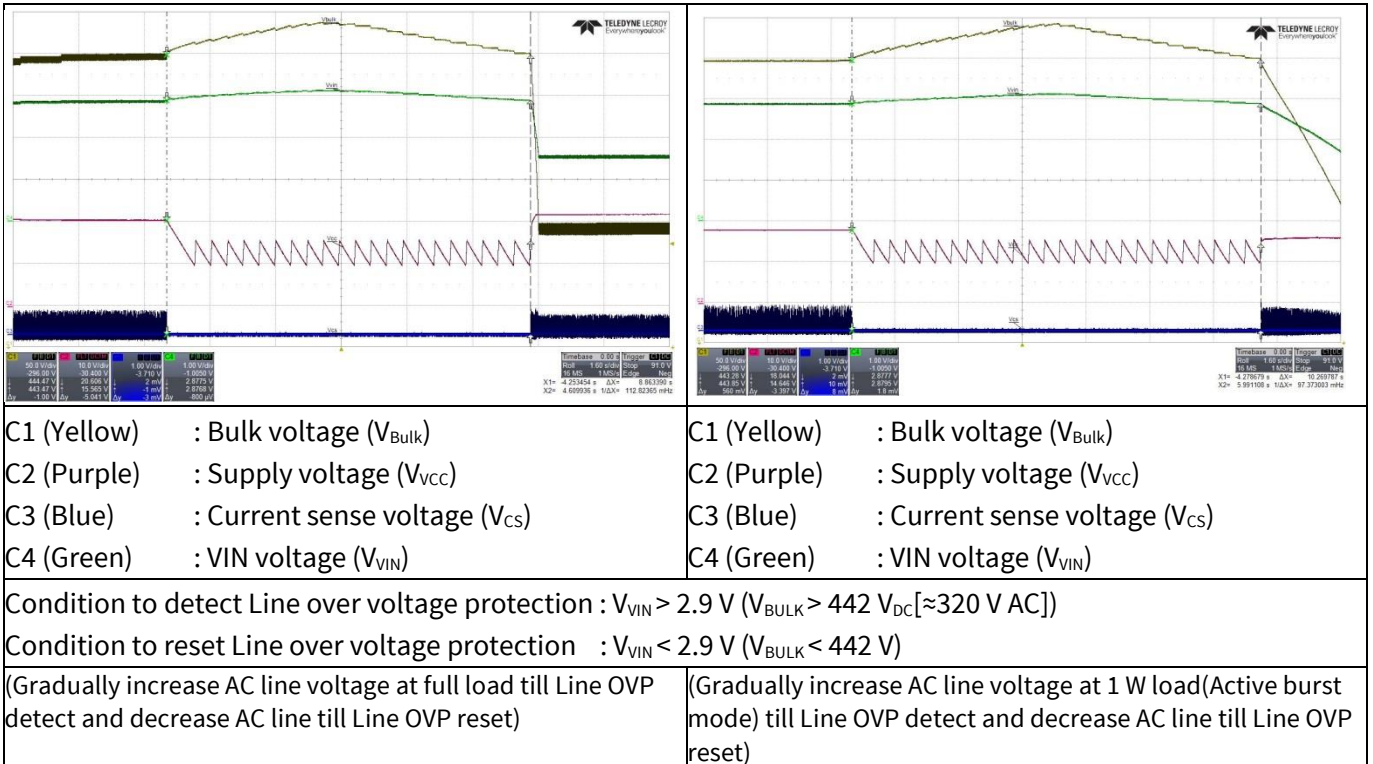

Figure 26 Line over voltage protection

11.12 Brownout protection (non switch auto restart)

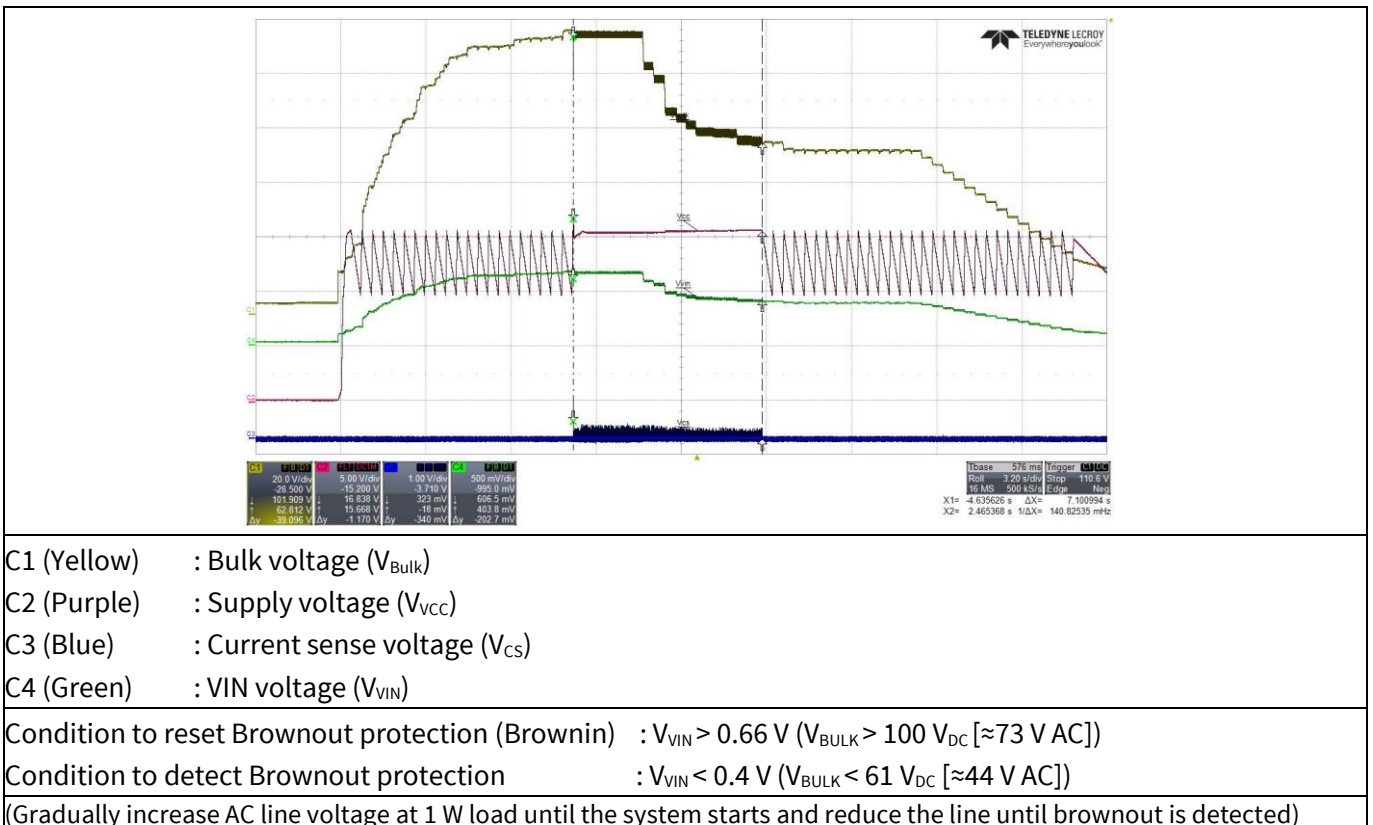
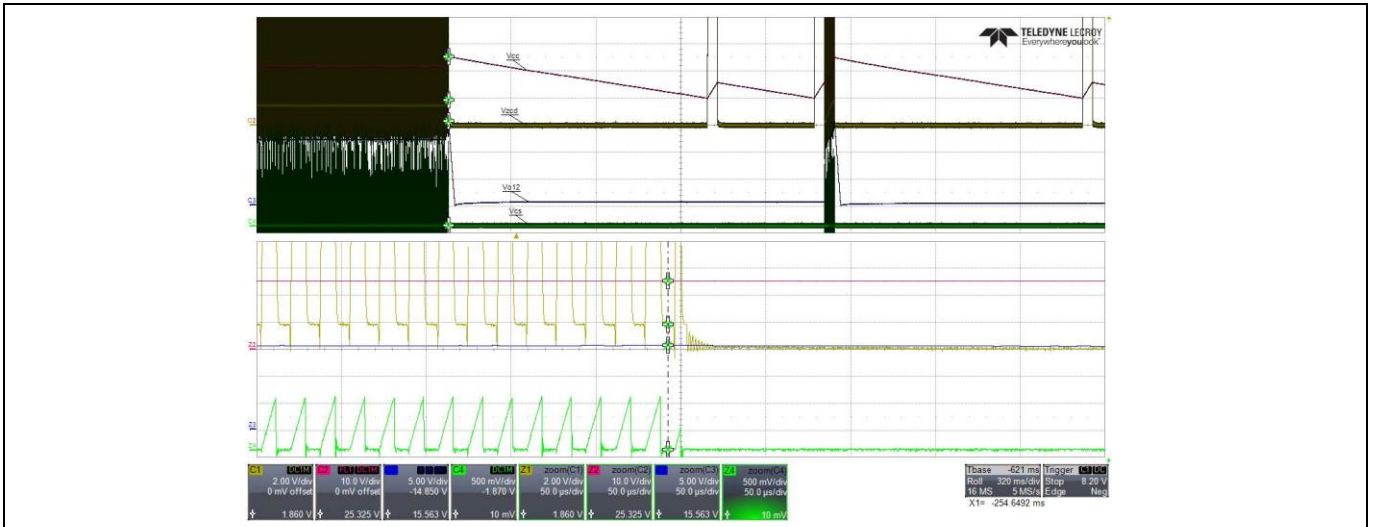

Figure 27 Brownout protection

### 11.13 $V_{CC}$ over voltage protection (odd skip auto restart)



- C1 (Yellow) : Zero crossing detection voltage ( $V_{ZCD}$ )
- C2 (Purple) : Supply voltage ( $V_{VCC}$ )
- C3 (Blue) : 12 V output voltage ( $V_{O12}$ )
- C4 (Green) : Current sense voltage ( $V_{CS}$ )

Condition to enter  $V_{VCC}$  over voltage protection:  $V_{VCC} > 25.5$  V  
 (85 V AC and remove R13, load change form 13 W to full load)

**Figure 28  $V_{CC}$  over voltage protection**

### 11.14 $V_{CC}$ under voltage protection (auto restart)

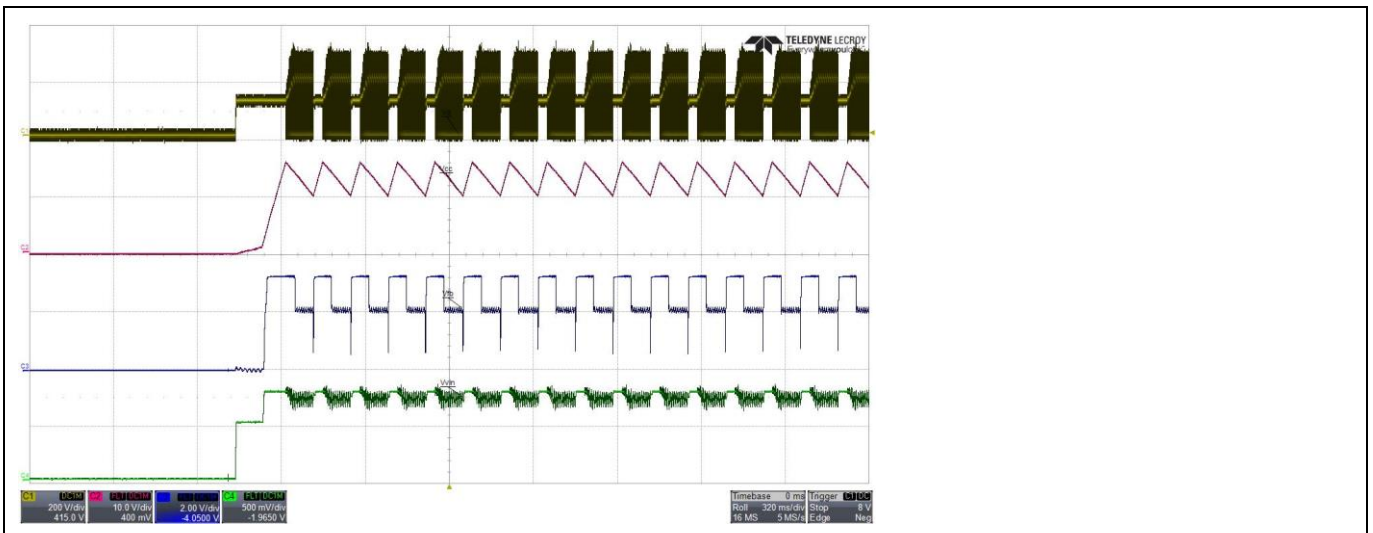

- C1 (Yellow) : Drain voltage ( $V_D$ )
- C2 (Purple) : Supply voltage ( $V_{VCC}$ )
- C3 (Blue) : Feedback voltage ( $V_{FB}$ )
- C4 (Green) : VIN voltage ( $V_{VIN}$ )

Condition to enter  $V_{CC}$  under voltage protection:  $V_{VCC} < 10$  V  
 (Remove R12A and power on the system with full load at 85 V AC)

**Figure 29  $V_{CC}$  under voltage protection**

Waveforms and scope plots

11.15 Over load protection (odd skip auto restart)

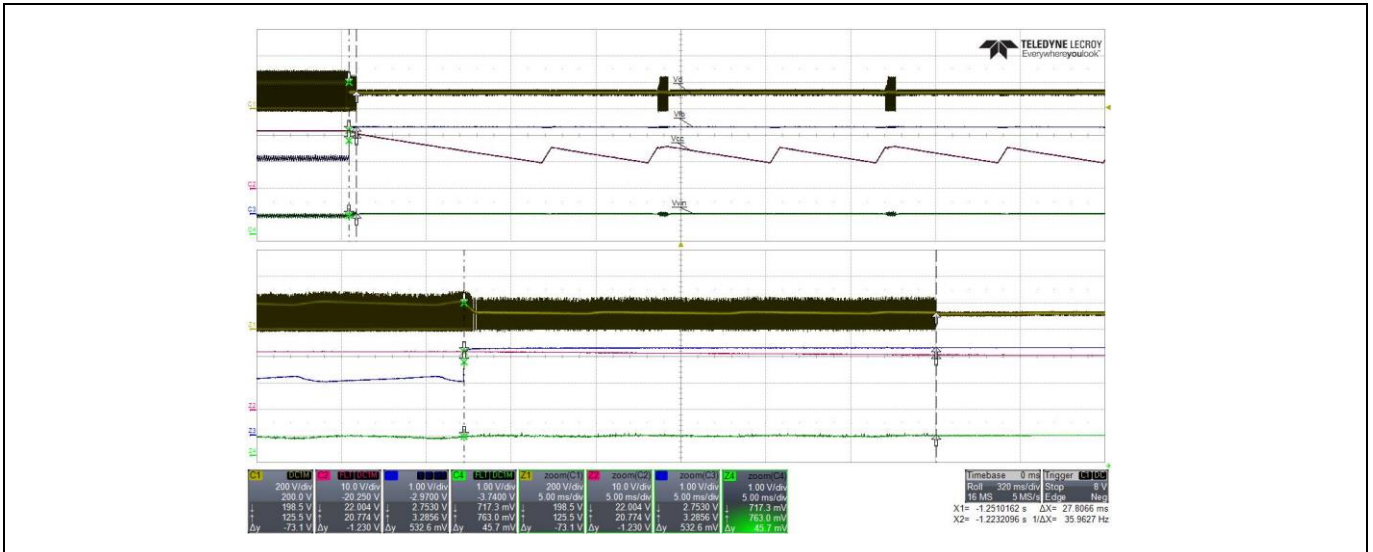

- C1 (Yellow) : Drain voltage ( $V_D$ )
- C2 (Purple) : Supply voltage ( $V_{VCC}$ )
- C3 (Blue) : Feedback voltage ( $V_{FB}$ )
- C4 (Green) : VIN voltage ( $V_{VIN}$ )

Condition to enter over load protection:  $V_{FB} > 2.75\text{ V}$  & last for 30ms blanking time  
(12 V output load change from full load to short at 85 V AC)

Figure 30 Over load protection

11.16 Output over voltage protection (odd skip auto restart)

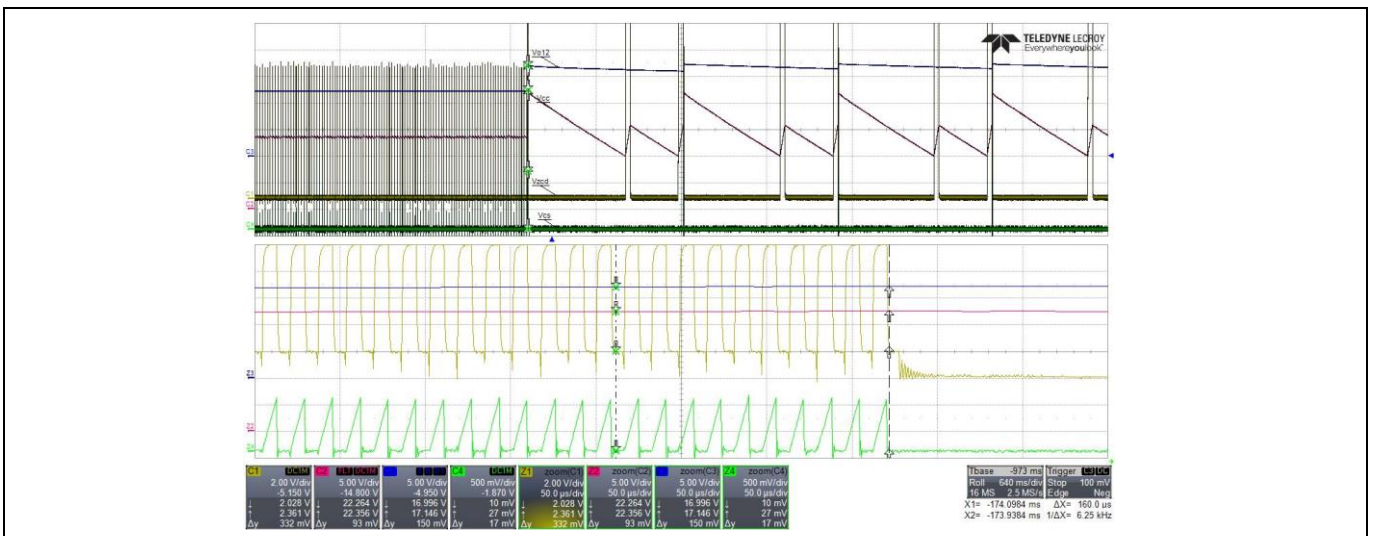

- C1 (Yellow) : Zero crossing detection voltage ( $V_{ZCD}$ )
- C2 (Purple) : Supply voltage ( $V_{VCC}$ )
- C3 (Blue) : 12 V output voltage ( $V_{O12}$ )
- C4 (Green) : Current sense voltage ( $V_{CS}$ )

Condition to enter output OVP:  $V_{O12} > 16.8\text{ V}$  ( $V_{ZCD} > 2\text{ V}$ )  
(85 V AC, short R26 during system operation at no load)

Figure 31 Output over voltage protection

Waveforms and scope plots

11.17 V<sub>CC</sub> short to GND protection

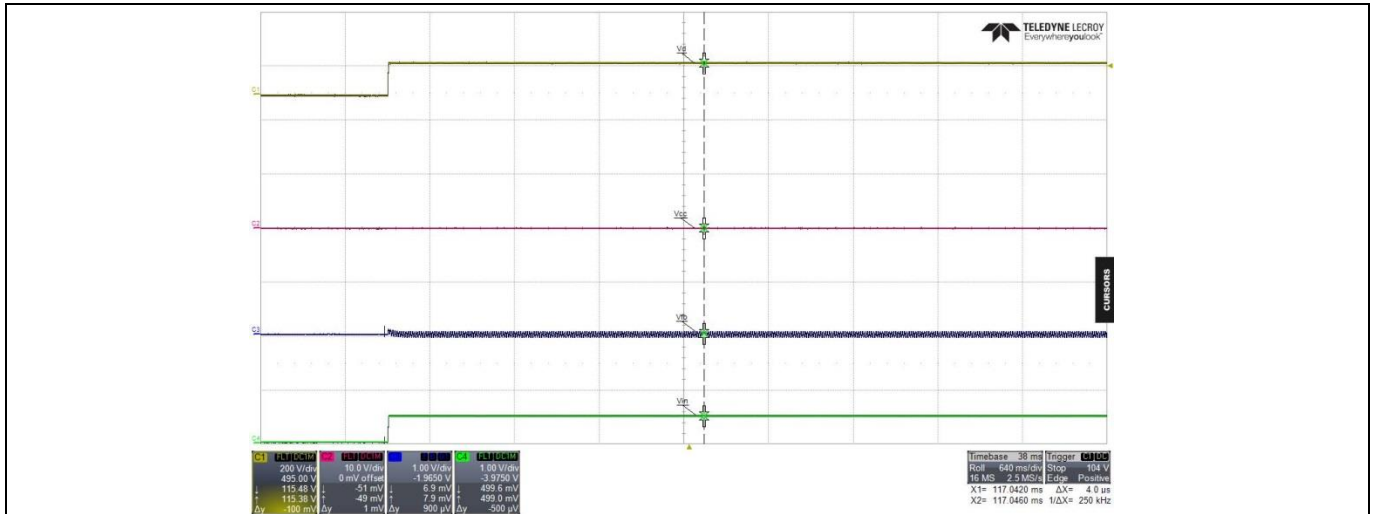

C1 (Yellow) : Drain voltage (V<sub>D</sub>)

C2 (Purple) : V<sub>CC</sub> voltage (V<sub>CC</sub>)

C3 (Blue) : Feedback voltage (V<sub>FB</sub>)

C4 (Green) : V<sub>IN</sub> voltage (V<sub>VIN</sub>)

Condition to enter V<sub>CC</sub> short to GND : if V<sub>CC</sub> < V<sub>VCC\_SCP</sub> → I<sub>VCC</sub> = I<sub>VCC\_Charge1</sub>

(Short V<sub>CC</sub> pin to Gnd by multi-metre and measure the current, I<sub>VCC</sub> ≈ 280 μA and input power is ≈ 50 mW at 85 V AC and full load)

Figure 32 V<sub>CC</sub> short to GND protection

## References

## 12 References

- [1] [ICE5QRxxxxAx datasheet, Infineon Technologies AG](#)
- [2] [AN-201609 PL83 026-5<sup>th</sup> Generation Quasi-Resonant Design Guide](#)

## Revision history

### Major changes since the last revision

Page or Reference	Description of change
--	First release.



#### Trademarks of Infineon Technologies AG

AURIX™, C166™, CanPAK™, CIPOS™, CoolGaN™, CoolMOS™, CoolSET™, CoolSiC™, CORECONTROL™, CROSSAVE™, DAVE™, DI-POL™, DrBlade™, EasyPIM™, EconoBRIDGE™, EconoDUAL™, EconoPACK™, EconoPIM™, EiceDRIVER™, eupec™, FCOS™, HITFET™, HybridPACK™, Infineon™, ISOFACE™, IsoPACK™, i-Wafer™, MIPAQ™, ModSTACK™, my-d™, NovalithIC™, OmniTune™, OPTIGA™, OptiMOS™, ORIGA™, POWERCODE™, PRIMARION™, PrimePACK™, PrimeSTACK™, PROFET™, PRO-SIL™, RASIC™, REAL3™, ReverSave™, SatRIC™, SiGET™, SiPMOS™, SmartLEWIS™, SOLID FLASH™, SPOC™, TEMPFET™, thinQ!™, TRENCHSTOP™, TriCore™.

Trademarks updated August 2015

#### Other Trademarks

All referenced product or service names and trademarks are the property of their respective owners.

**Edition 2017-03-10**

**Published by**

**Infineon Technologies AG**

**81726 Munich, Germany**

**© 2017 Infineon Technologies AG.**

**All Rights Reserved.**

**Do you have a question about this document?**

**Email: [erratum@infineon.com](mailto:erratum@infineon.com)**

**Document reference**

**AN\_201609\_PL83\_025**

#### IMPORTANT NOTICE

The information contained in this application note is given as a hint for the implementation of the product only and shall in no event be regarded as a description or warranty of a certain functionality, condition or quality of the product. Before implementation of the product, the recipient of this application note must verify any function and other technical information given herein in the real application. Infineon Technologies hereby disclaims any and all warranties and liabilities of any kind (including without limitation warranties of non-infringement of intellectual property rights of any third party) with respect to any and all information given in this application note.

The data contained in this document is exclusively intended for technically trained staff. It is the responsibility of customer's technical departments to evaluate the suitability of the product for the intended application and the completeness of the product information given in this document with respect to such application.

For further information on the product, technology, delivery terms and conditions and prices please contact your nearest Infineon Technologies office ([www.infineon.com](http://www.infineon.com)).

#### WARNINGS

Due to technical requirements products may contain dangerous substances. For information on the types in question please contact your nearest Infineon Technologies office.

Except as otherwise explicitly approved by Infineon Technologies in a written document signed by authorized representatives of Infineon Technologies, Infineon Technologies' products may not be used in any applications where a failure of the product or any consequences of the use thereof can reasonably be expected to result in personal injury.