

# 130 W PFC + LLC LED driver design based on ICL5102

## 1 percent dimming with wide LED voltage and an integrated LLC transformer

Board sales name: REF-ICL5102-U130W-CC

Author: Yi Wang



### About this document



#### Scope and purpose

**ICL5102** is an integrated combo controller IC aimed to control and drive the boost PFC + resonant half-bridge (HB) topology (LLC/LCC) combined. The superior performance of its THD optimizer makes it very suitable for applications with stringent requirements on the input power quality, such as LED lighting. Infineon's proprietary coreless transformer-based high-side (HS) MOSFET driver enables a robust and efficient HB drive at high operating frequency up to 500 kHz in the steady-state.

This work reports the experimental results of a 130 W PFC + LLC LED driver design based on our ICL5102 controller and cost-effective 650 V MOSFETs of the P7 series. Key performance of this board:

1. An integrated LLC transformer design
2. 93 percent system efficiency at full power, 230 V<sub>RMS</sub> and 50 Hz
3. 1 percent analog dimming in a wide LED voltage range (38~76 V)
4. Excellent power quality
  - a. THD < 10 percent for load > 10 percent power at 267 V<sub>RMS</sub> and 50 Hz
  - b. PF > 0.9 for load > 20 percent power at 267 V<sub>RMS</sub> and 50 Hz
  - c. Harmonics fulfilling IEC61000-3-2 class C edition 5.1 above 10 percent load

#### Intended audience

This document is intended for technical experts who intend to use this ICL5102 demonstration board, either for ICL5102 functional tests, or as a reference for an ICL5102-based product development.

**Table of contents**

**Table of contents**

<b>About this document.....</b>	<b>1</b>
<b>Table of contents.....</b>	<b>2</b>
<b>1 IC introduction.....</b>	<b>3</b>
<b>2 Board description.....</b>	<b>4</b>
2.1 Electrical specification .....	4
2.2 Schematics and layouts .....	6
2.3 Board setup .....	10
<b>3 Electrical performance .....</b>	<b>11</b>
3.1 System performance .....	11
3.2 Steady-state waveforms .....	13
3.3 Start-up behavior .....	14
3.4 Load transient .....	15
3.5 Protections .....	16
3.5.1 Brown-out protection .....	16
3.5.2 Open load protection.....	16
<b>4 Thermal performance .....</b>	<b>17</b>
<b>5 EMI performance.....</b>	<b>18</b>
<b>6 Datasheets of magnetic components.....</b>	<b>19</b>
<b>7 Bill of materials.....</b>	<b>23</b>
<b>Revision history.....</b>	<b>27</b>

### IC introduction

## 1 IC introduction

ICL5102 is an integrated combo IC designed to drive and control the boost PFC + resonant HB topology (LLC/LCC) in combination. The normal voltage version (650 V max.) can cover the applications with universal mains up to 305 V<sub>RMS</sub>, while its high-voltage version, ICL5102HV, can handle 980 V (max. value) on the HB driver part, which is suited to horticultural lighting applications and other industrial applications where the input mains voltage is up to 530 V<sub>RMS</sub>.

The pin maps of **ICL5102** and **ICL5102HV** are given in **Figure 1**. Thanks to Infineon's proprietary coreless transformer technology, ICL5102/HV's high-side MOSFET driver is very robust against dV/dt and negative voltage peak on the switch node of the half bridge, and it is very efficient at high operating frequency.

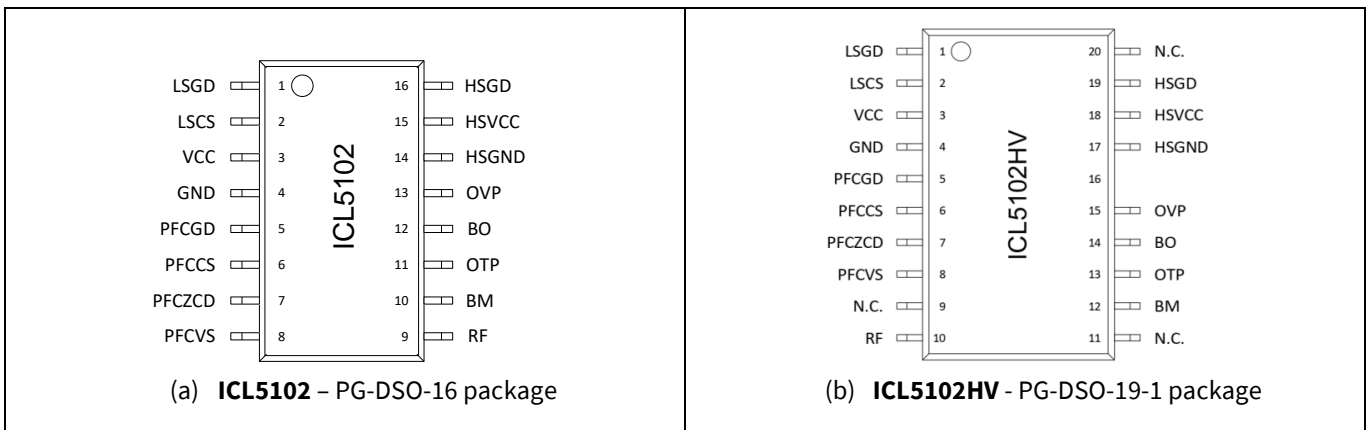

**Figure 1 Pin maps of (a) ICL5102 and (b) ICL5102HV**

The other key features of ICL5102 are summarized as follows:

### Key features:

- Integrated two-stage combo controller allowing for reduced number of external components, optimized bill of materials (BOM) and form factor.
- Maximum **500 kHz** HB switching frequency in continuous operation and soft-start frequency up to 1.3 MHz.
- THD optimization ensuring best-class THD performance and low harmonic distortion at light load. Easy to pass IEC61000-3-2 class C edition 5.1.
- PFC controller with critical conduction mode (CrCM) and discontinuous conduction mode (DCM).
- Resonant HB controller with fixed or variable switching frequency control.
- Burst mode supporting the standby mode with low power consumption (<500 mW, system level).
- Supports universal AC input voltage and excellent system efficiency.

### Protection coverage:

- Input brown-out protection
- PFC bus overvoltage protection (OVP)
- PFC overcurrent protection (OCP)
- Output OVP, OCP/short-circuit protection
- Output overpower/overload protection (OPP)
- Half-bridge capacitive mode protection
- Overtemperature protection (OTP)

**Board description**

## 2 Board description

This 130 W demonstration board has been designed to show the great power quality of an ICL5102-based PFC+LLC converter for LED lighting application. A possibility of 1 percent analog dimming of an LLC topology with a wide LED output range is also demonstrated with an integrated and compact LLC transformer. Here, the 1 percent dimming is realized without entering the burst mode and hence, a great light quality is guaranteed to fulfill the more and more stringent requirements of temporal light artifacts (TLA), such as LED current modulation limitation in IEEE1789 recommendation, and the stroboscopic visibility measure (SVM) and  $P_{st}^{LM}$  limitation in the EU single lighting regulation.

The main characteristics of this demonstration board are summarized below:

1. An integrated LLC transformer designed for size and cost reduction
2. 93 percent system efficiency at 130 W, 230 V<sub>RMS</sub>, 50 Hz
3. 1 percent analog dimming in a wide LED voltage range (38~76 V), without entering the burst mode
4. Excellent power quality
  - a. THD < 10 percent for load > 10 percent power at 267 V<sub>RMS</sub>, 50 Hz
  - b. PF > 0.9 for load > 20 percent power at 267 V<sub>RMS</sub>, 50 Hz
  - c. Harmonics fulfilling IEC61000-3-2 class C edition 5.1 above 10 percent load
5. Infineon’s cost-effective P7 series MOSFETs are used for both PFC and LLC stages.

### 2.1 Electrical specification

This LED driver is designed to have a rectangular output window, which is shown in **Figure 2**. The driver can be dimmed down via an easy-to-use 0-10 V analog dimming interface. At 10 V dimming voltage, the output is supposed to provide approximately 1.71 A within the given output LED voltage range. With 38 V LED voltage, the driver can generate 1.3 W output power at very low dimming voltage.

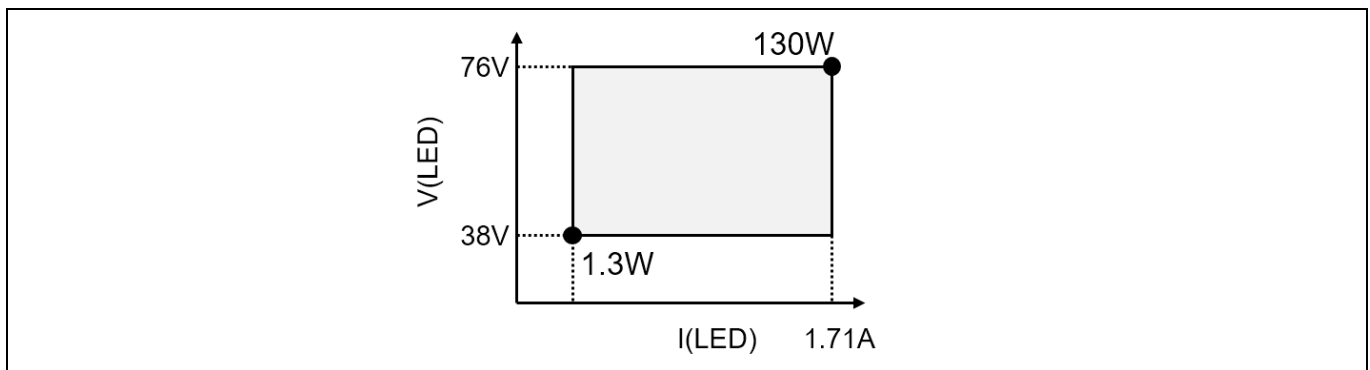

**Figure 2** Output operating window

**Table 1** lists the key electrical specifications of this demo board.

**Table 1** Key electrical specifications

Item	Symbol	Min.	Typ.	Max.	Unit	Remarks
AC input voltage	V <sub>in,ac</sub>	90	–	267	V <sub>RMS</sub>	
Brown-out voltage	V <sub>in,BO</sub>	–	83	–	V <sub>RMS</sub>	Tested 50 Hz mains
Brown-in voltage	V <sub>in,BI</sub>	–	90	–	V <sub>RMS</sub>	Tested 50 Hz mains
Input frequency	f <sub>in</sub>	47	–	63	Hz	
Efficiency	η	–	93 percent	–	–	100 percent load at 230 V <sub>RMS</sub> , 50 Hz

**130 W PFC + LLC LED driver design based on ICL5102**  
**1 percent dimming with wide LED voltage and an integrated LLC transformer**



**Board description**

Item	Symbol	Min.	Typ.	Max.	Unit	Remarks
Rated LED voltage	$V_{LED}$	38	–	76	V	
LED current range	$I_{LED}$	0.017	–	1.72	A	
LED power	$P_{LED}$	–	–	130	W	
Analog dimming voltage	$V_{DIM}$	0	–	10	V	
LLC frequency range	$f_{LLC}$	35*	–	65**	kHz	* $V_{LED} = 76\text{ V}$ , $V_{DIM} = 10\text{ V}$ ** $V_{LED} = 38\text{ V}$ , $V_{DIM} = 0.1\text{ V}$
Total harmonic distortion	THD	–	–	10	percent	Greater than 10 percent load at 267 $V_{RMS}$ , 50 Hz
Power factor	PF	0.9	–	–		Greater than 20 percent load
Time-to-light	T2L			0.5	s	
EMI	EN 55015					Tested at full load and half load
Harmonics	EN 61000-3-2 class C, edition 5.1					Greater than 10 percent load at 230 $V_{RMS}$ , 50 Hz

# 130 W PFC + LLC LED driver design based on ICL5102

## 1 percent dimming with wide LED voltage and an integrated LLC transformer

### Board description

## 2.2 Schematics and layouts

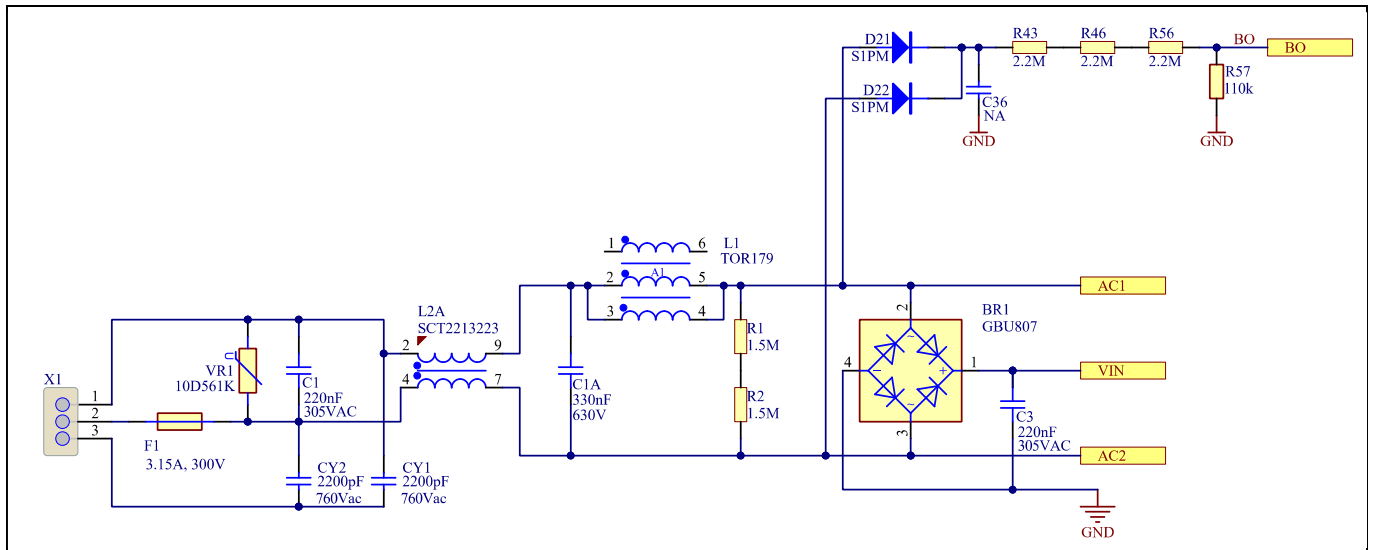

**Figure 3 Schematic of the input EMI filter and the brown-out sensing network**

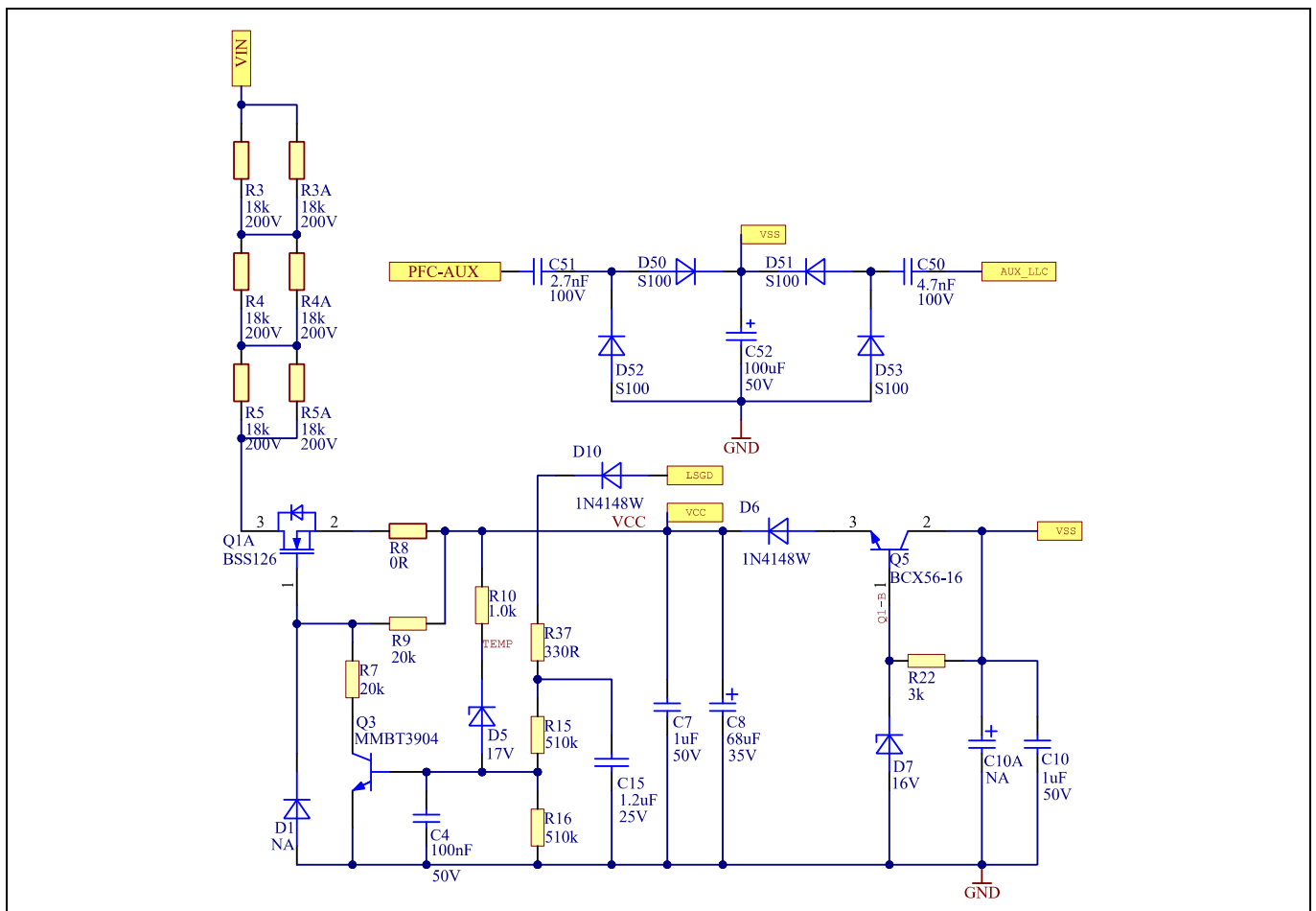

**Figure 4 Schematic of the start-up and V<sub>CC</sub> circuit**

# 130 W PFC + LLC LED driver design based on ICL5102

## 1 percent dimming with wide LED voltage and an integrated LLC transformer

### Board description

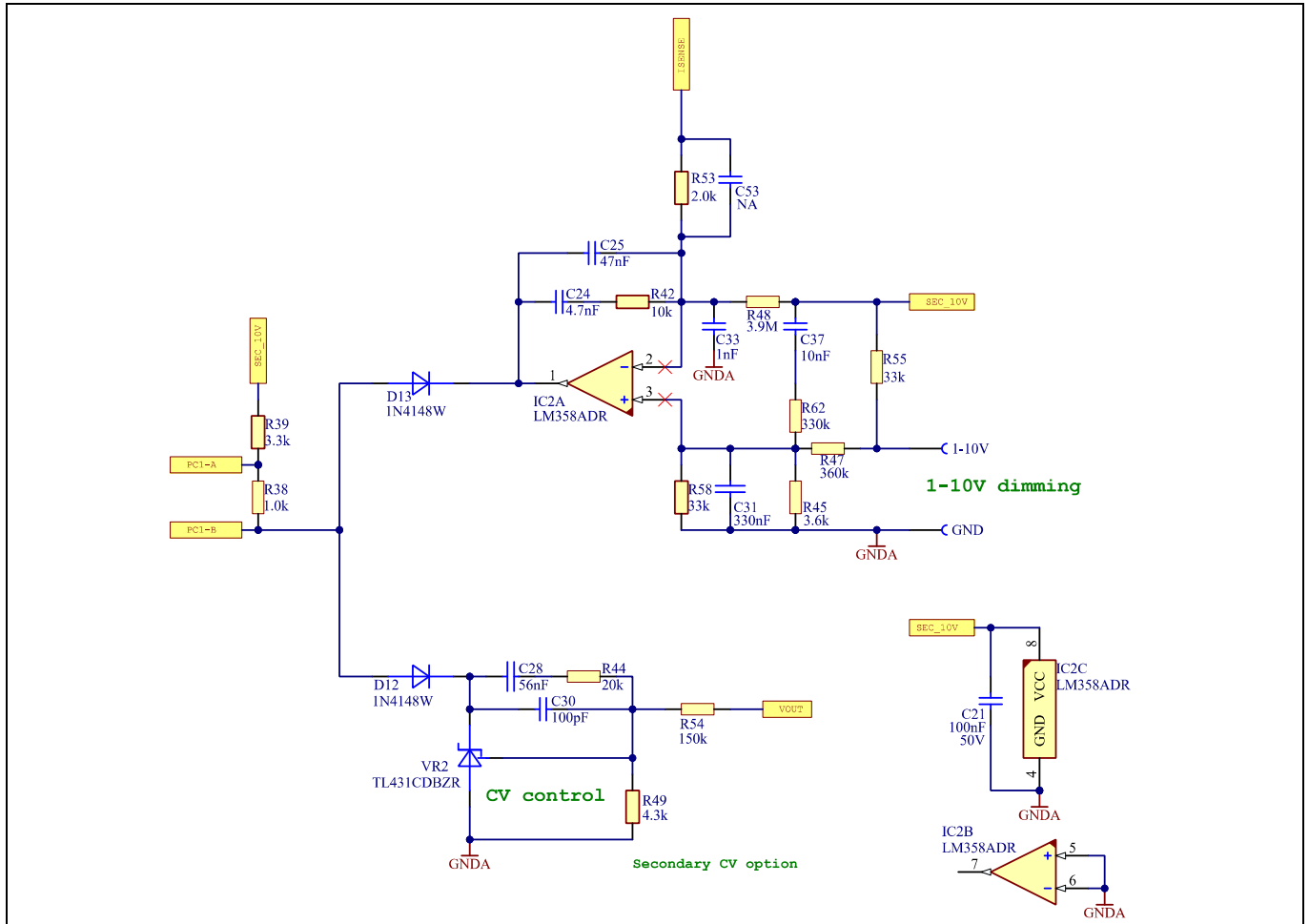
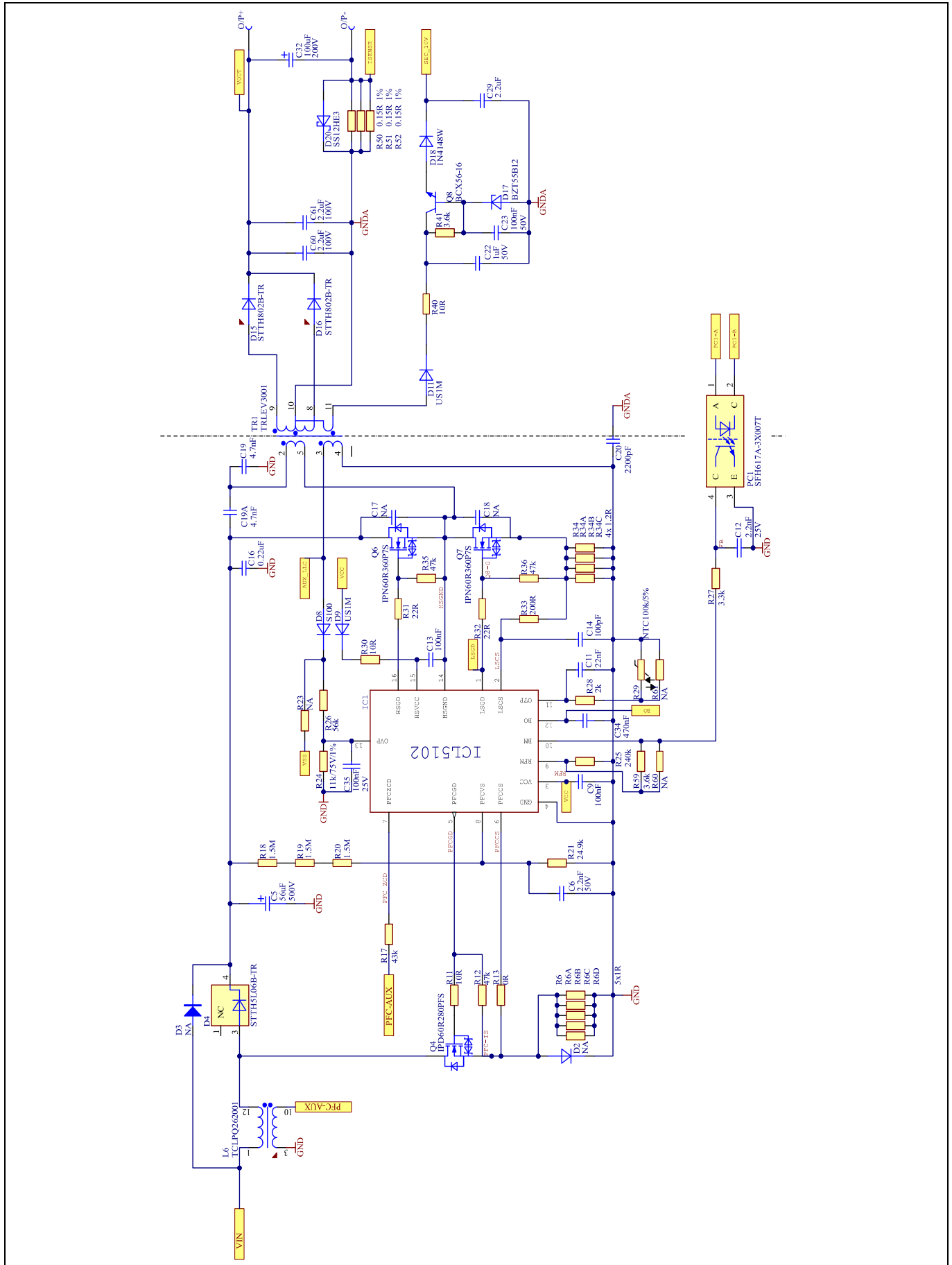

Figure 5 Schematic of the secondary-side control circuit

# 130 W PFC + LLC LED driver design based on ICL5102

## 1 percent dimming with wide LED voltage and an integrated LLC transformer

### Board description



**Figure 6 Schematic of the main power stage**



# 130 W PFC + LLC LED driver design based on ICL5102

## 1 percent dimming with wide LED voltage and an integrated LLC transformer



### Board description

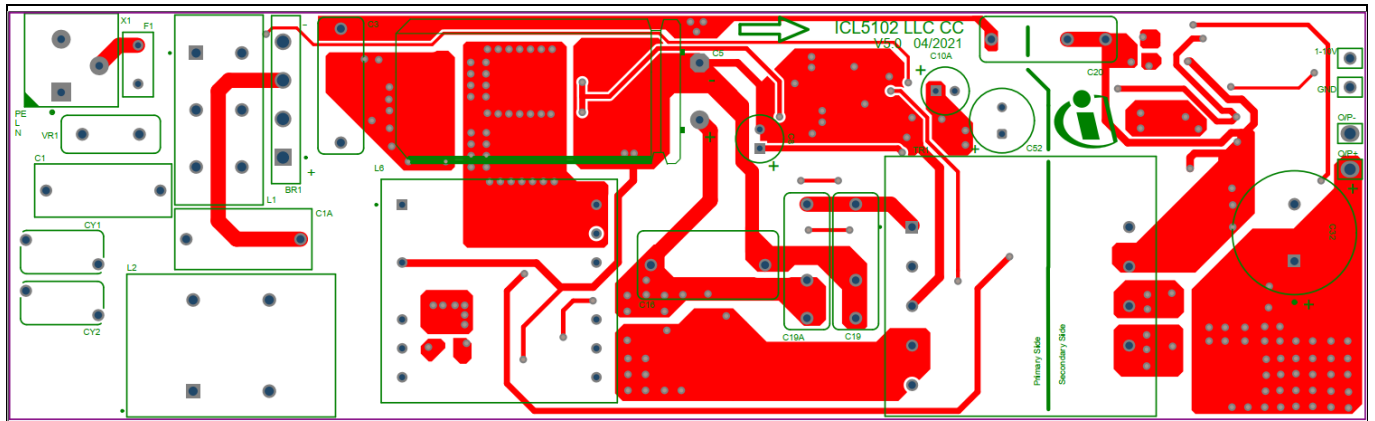

Figure 7 Layout of the through-hole component side

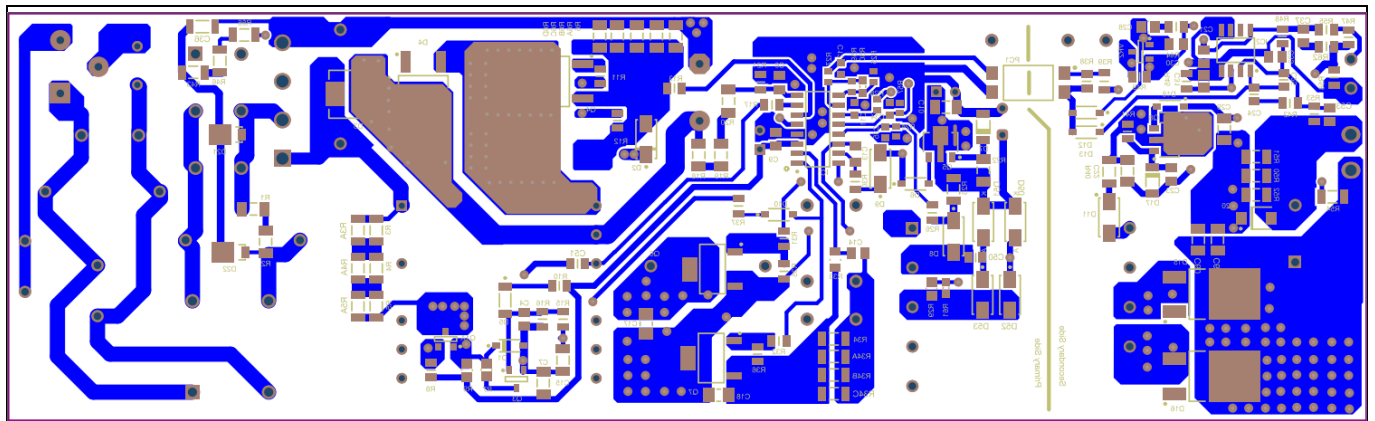

Figure 8 Layout of the SMD component side

# 130 W PFC + LLC LED driver design based on ICL5102

## 1 percent dimming with wide LED voltage and an integrated LLC transformer

### Board description

### 2.3 Board setup

This 18 cm long board has a two-sided PCB with 2 oz. (70  $\mu\text{m}$ ) copper thickness. An external DC voltage supply (the maximum output voltage is at least 10 V and output current rating is at least 100 mA) should be connected to the LED side for dimming.

Here, the PFC inductor is the size of a PQ2625 core set and the integrated LLC transformer uses a special EV30 core set, which is 5 mm longer in total than a standard EVD25 core.

The PCB and its connectors are indicated in **Figure 9a**. **Please pay attention to the connector polarities.**

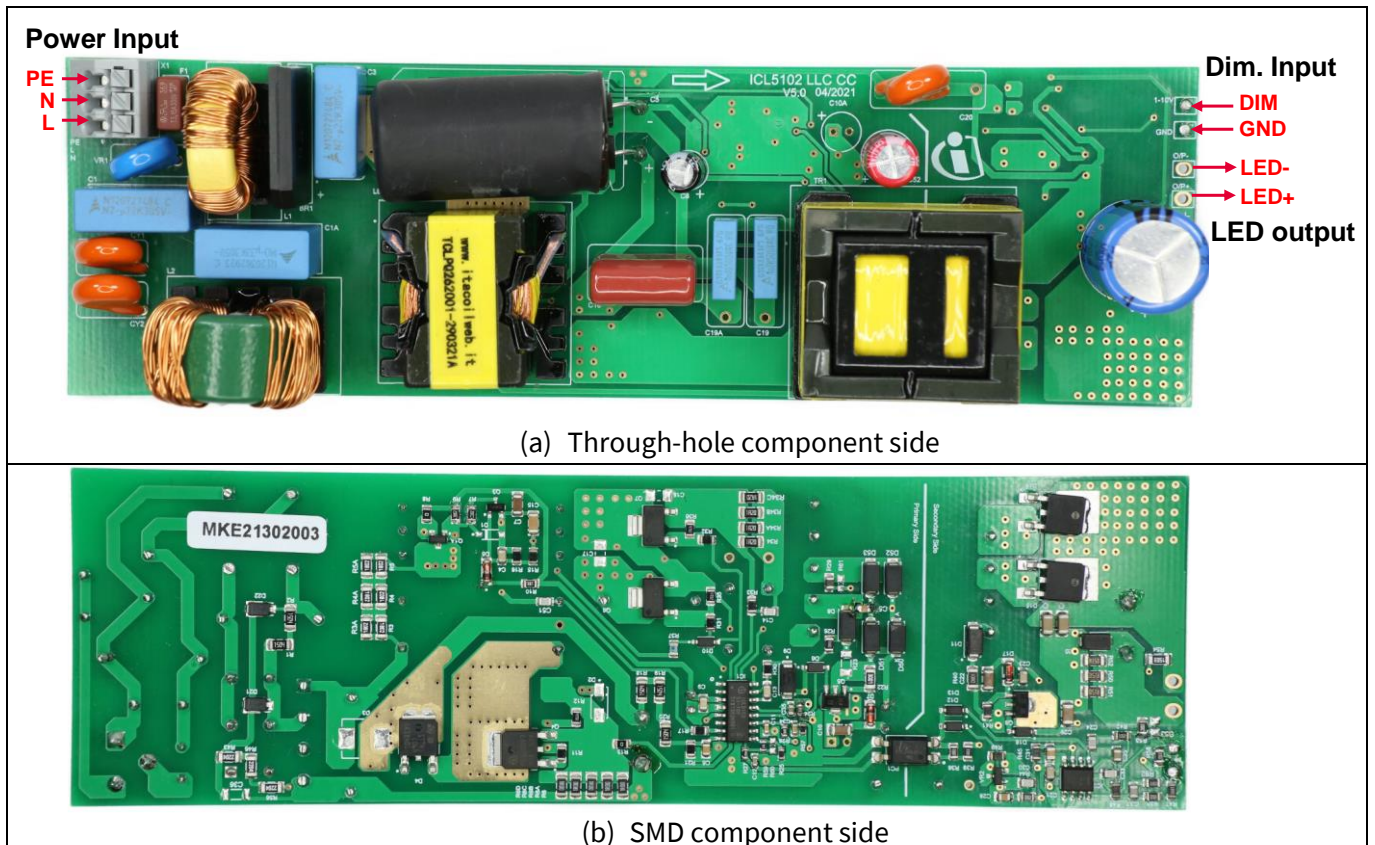

**Figure 9 Board images**

**Electrical performance**

### 3 Electrical performance

The electrical performance of this board is shown below, in the aspects of:

- System performance (LED current dimming curve, system efficiency, THD, power factor and input current harmonics)
- Steady-state waveforms
- Start-up behavior
- Load transient behavior
- Protection behavior (brown-out protection, output OVP)

#### 3.1 System performance

**Figure 10** shows the measured LED current curve with the dimming voltage. These curves are pretty linear all the way down to 0.1 V.

**Figure 11** illustrates the system efficiency from 100 percent to 1 percent load. At full load with 230 V<sub>RMS</sub> input, the efficiency is around 93 percent, and this value comes to about 91.4 percent when input is 120 V<sub>RMS</sub>. The efficiency measurement is done after the driver has been thermally stabilized.

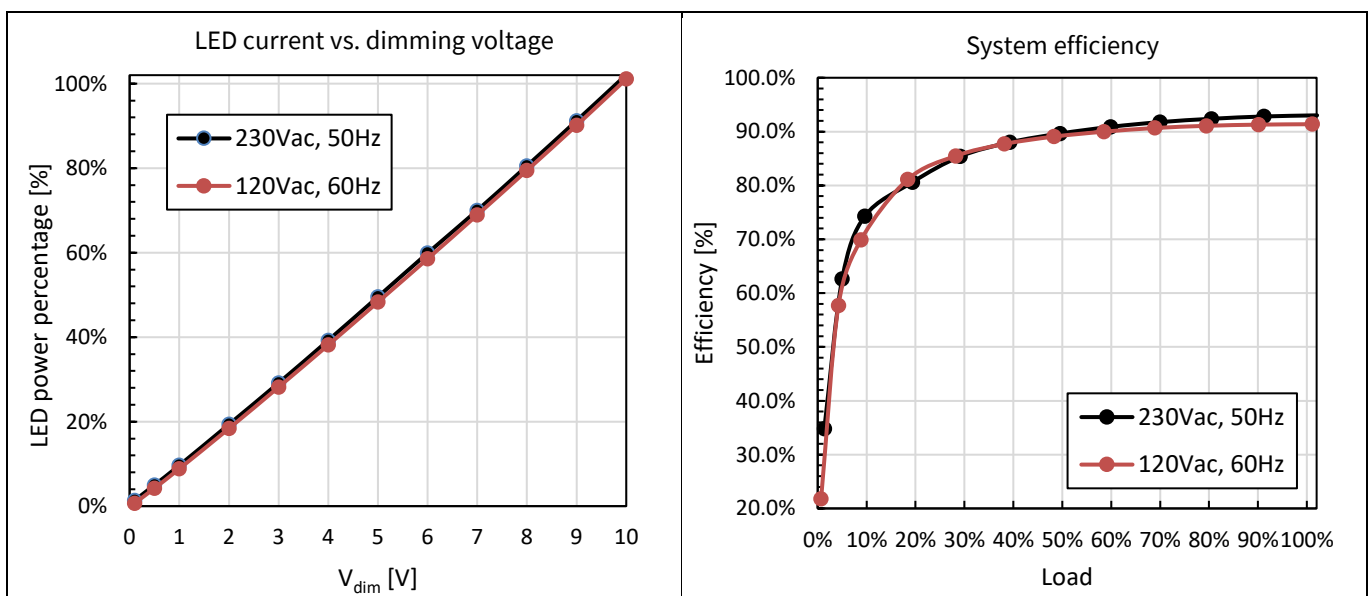

**Figure 10 LED current vs. dimming voltage**  
 (V<sub>LED</sub> = 76 V)

**Figure 11 System efficiency vs. load (V<sub>LED</sub> = 76 V)**

**Figure 12** presents the input power factor with the LED load. It shows that even at the mains conditions of 277 V AC, 60 Hz (which is beyond our board specification), the board can still achieve greater than 0.9 power factor above 30 percent load. At 267 V AC and 50 Hz, power factor of greater than 0.9 is possible for loads above 20 percent.

The excellent power quality of this board can also be seen from the THD performance. **Figure 13** provides the measured THD result at various load and input voltage conditions. It can be seen that the THD is smaller than 10 percent at load greater than 10 percent over the full input ranges.

**Figure 14** and **Figure 15** show the input current harmonics results at full load and 10 W load. Both fulfill the requirements of IEC61000-3-2 class C, edition 5.1.

# 130 W PFC + LLC LED driver design based on ICL5102

## 1 percent dimming with wide LED voltage and an integrated LLC transformer

### Electrical performance

The excellent input power quality is the result of the EMI filter and the THD optimizer function within ICL5102.

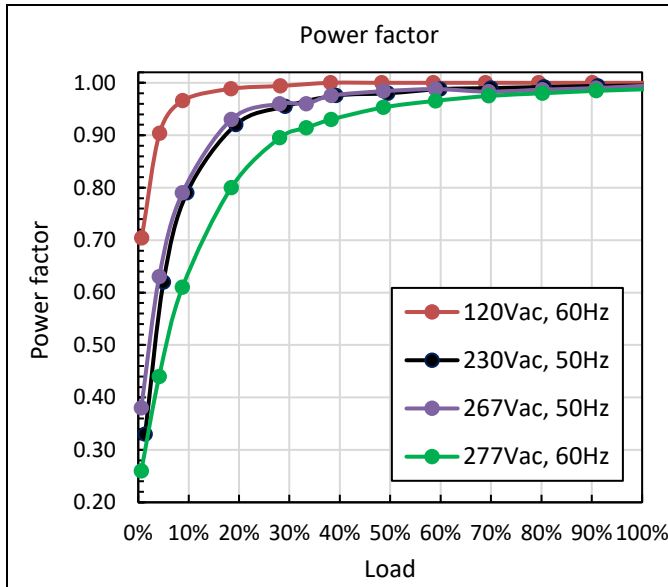

Figure 12 Power factor vs. load

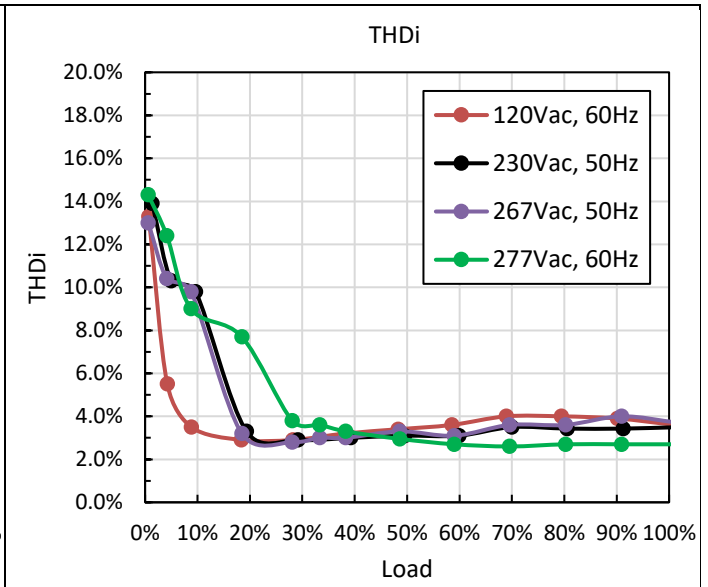

Figure 13 THD vs. load

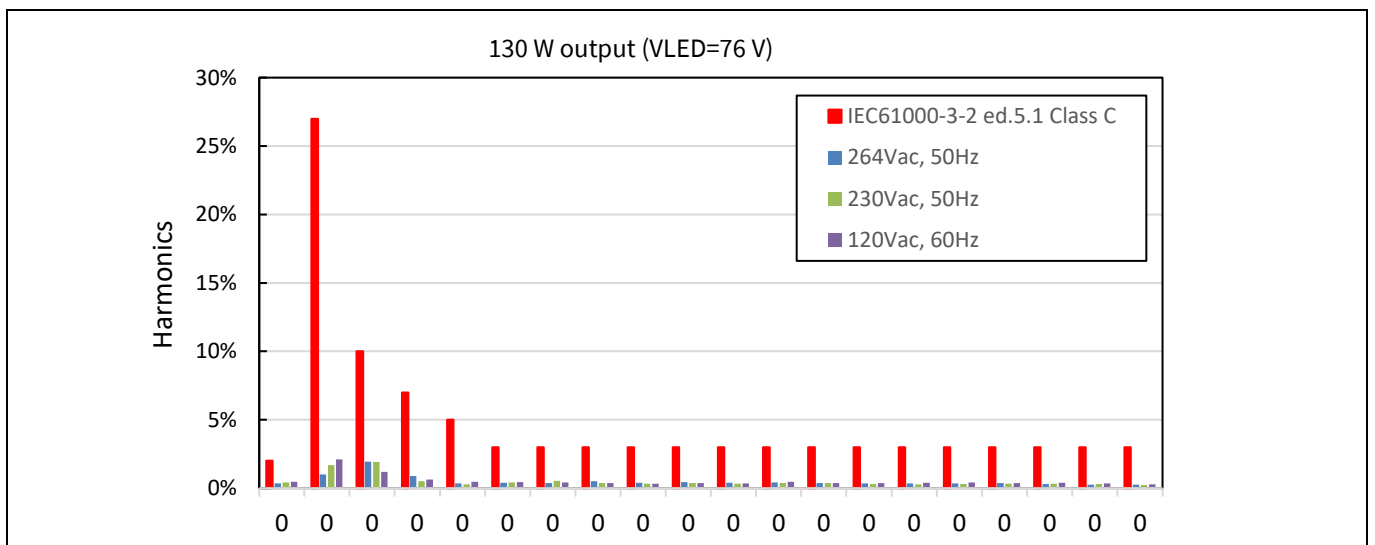
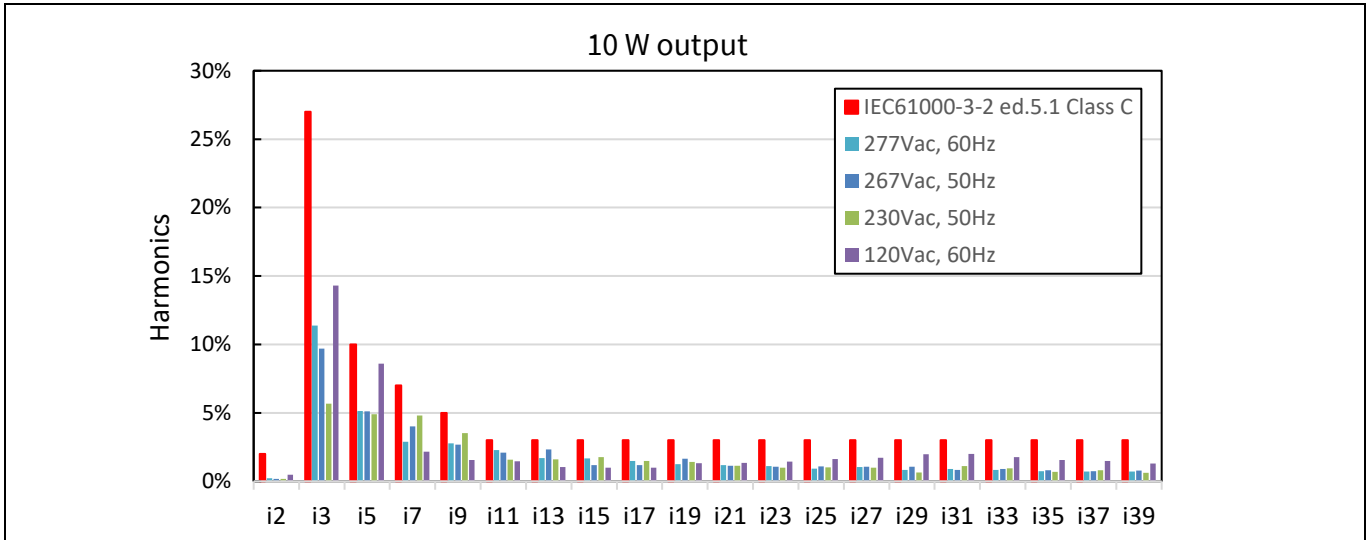

Figure 14 Input current harmonics at 130 W load

# 130 W PFC + LLC LED driver design based on ICL5102

## 1 percent dimming with wide LED voltage and an integrated LLC transformer

### Electrical performance



**Figure 15** Input current harmonics at 10 W load

### 3.2 Steady-state waveforms

The key waveforms at various input voltages, and at full load and 1 percent load, are shown in **Figure 16** to **Figure 19**. In each measurement of these figures, the number of LEDs in series is the same, but the LED current drives the LED voltage differently due to the dynamic resistance.

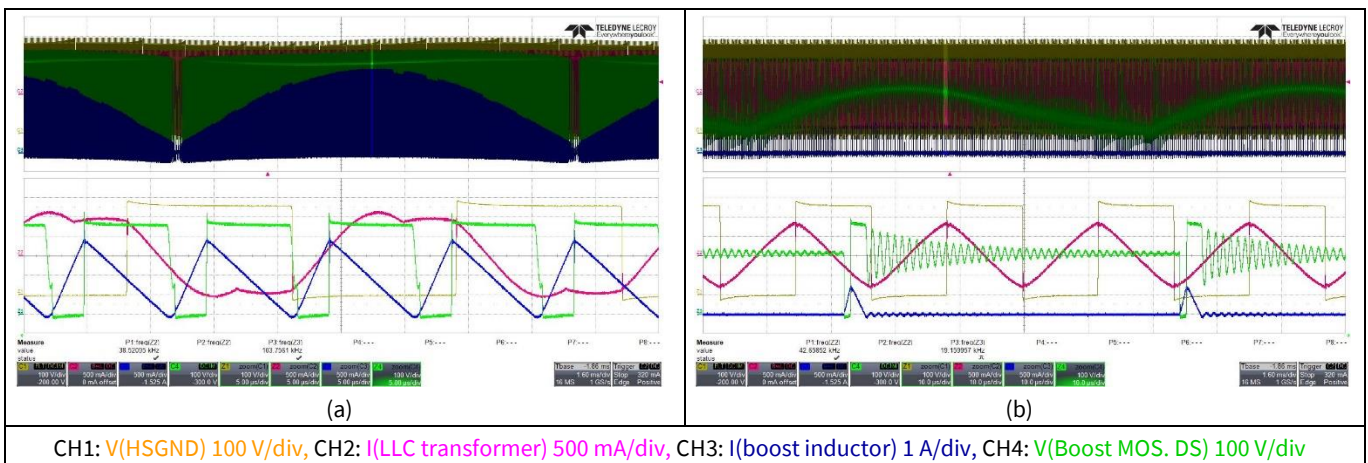

**Figure 16** Boost and LLC waveforms at 230 V<sub>RMS</sub> (a) V<sub>dim</sub> = 10 V, V<sub>LED</sub> = 76 V and (b) V<sub>dim</sub> = 0.1 V, V<sub>LED</sub> = 65 V

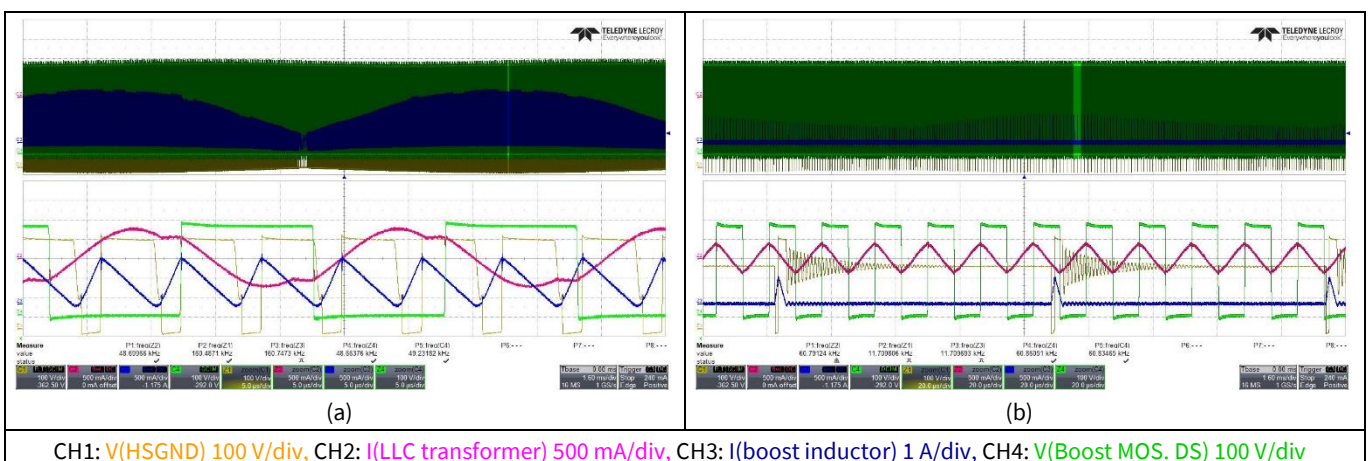
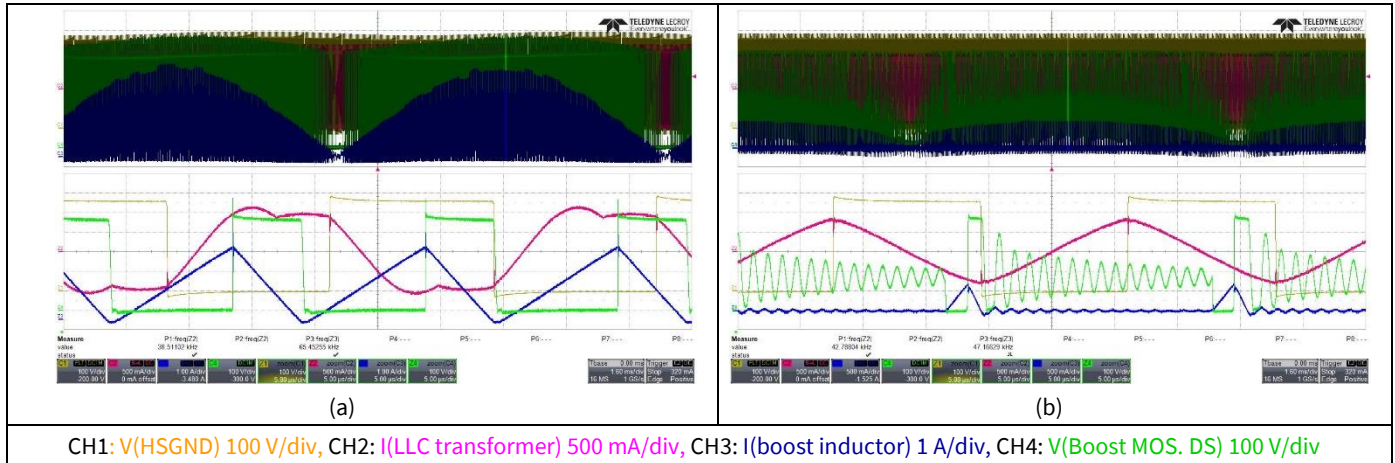

**Figure 17** Boost and LLC waveforms at 230 V<sub>RMS</sub> (a) V<sub>dim</sub> = 10 V, V<sub>LED</sub> = 46 V and (b) V<sub>dim</sub> = 0.1 V, V<sub>LED</sub> = 39 V

# 130 W PFC + LLC LED driver design based on ICL5102

## 1 percent dimming with wide LED voltage and an integrated LLC transformer

### Electrical performance



**Figure 18** Boost and LLC waveforms at 120 V<sub>RMS</sub> (a) V<sub>dim</sub> = 10 V, V<sub>LED</sub> = 76 V and (b) V<sub>dim</sub> = 0.1 V, V<sub>LED</sub> = 65 V

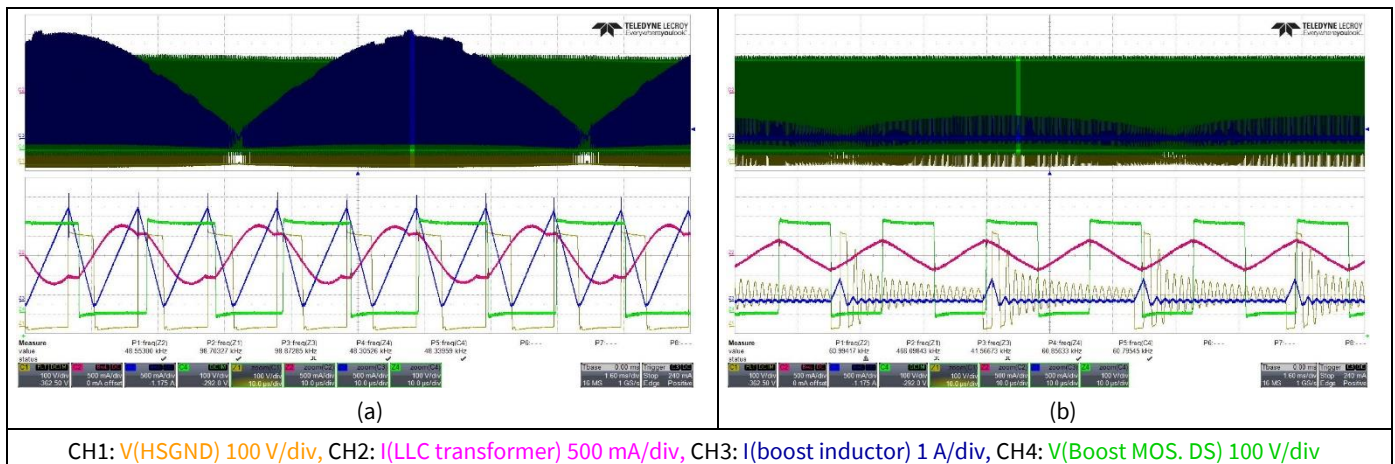

**Figure 19** Boost and LLC waveforms at 120 V<sub>RMS</sub> (a) V<sub>dim</sub> = 10 V, V<sub>LED</sub> = 46 V and (b) V<sub>dim</sub> = 0.1 V, V<sub>LED</sub> = 39 V

### 3.3 Start-up behavior

The start-up behavior of the V<sub>CC</sub> voltage, LED current, etc. at various input voltages, LED voltages and dimming voltages are recorded via **Figure 20 (a to d)**. Here, the time-to-light (less than 0.5 s) can be observed from the V<sub>CC</sub> ramping up to the LED current ramping up.

# 130 W PFC + LLC LED driver design based on ICL5102

## 1 percent dimming with wide LED voltage and an integrated LLC transformer

### Electrical performance

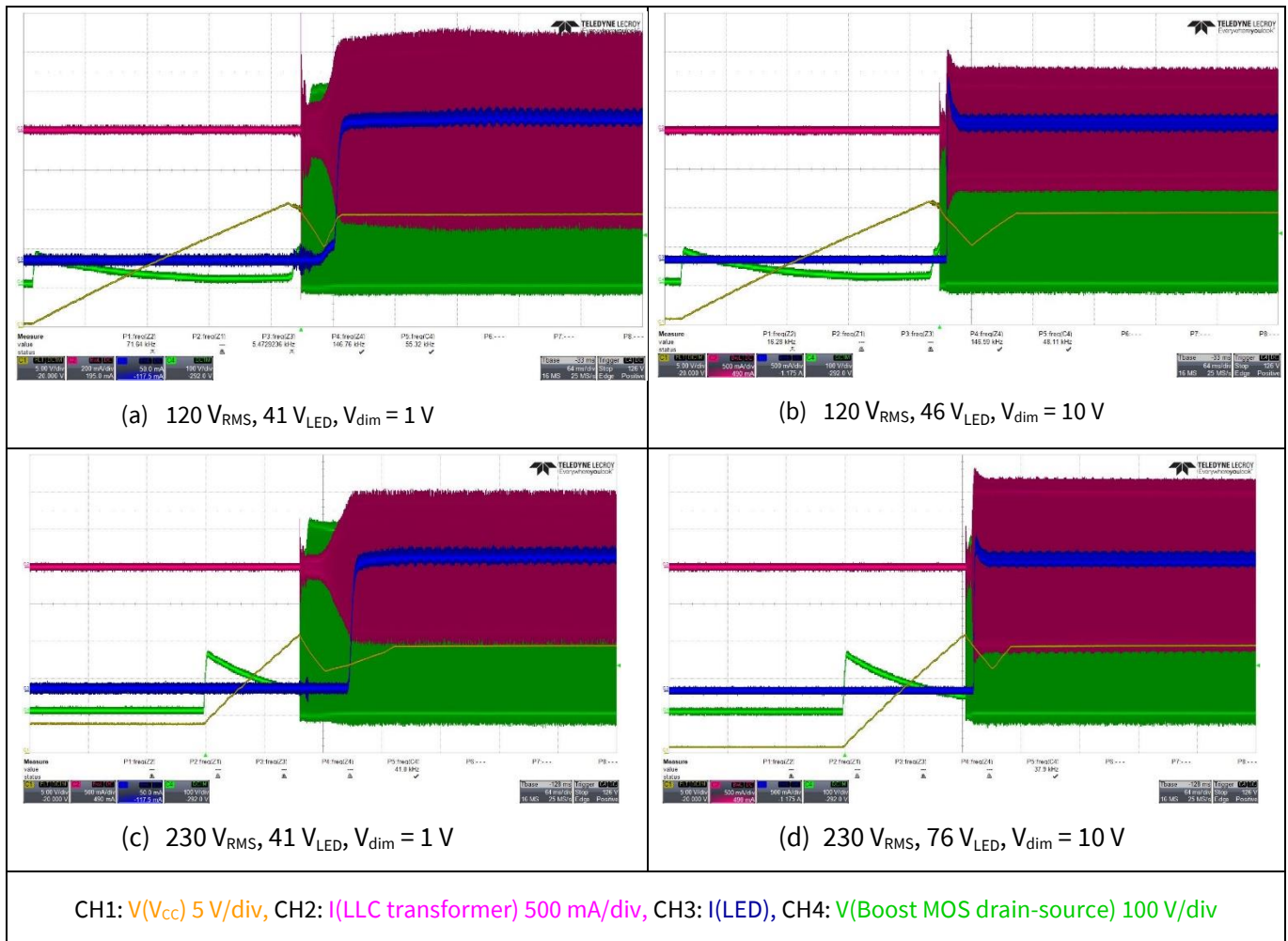

**Figure 20** Start-up behavior of the  $V_{cc}$ , LED current, LLC transformer current at different operating conditions (a to d)

### 3.4 Load transient

**Figure 21** shows the LED current transient when the dimming voltage jumps from 0.1 V to 10 V in 6 ms. The LED current ramps up smoothly.

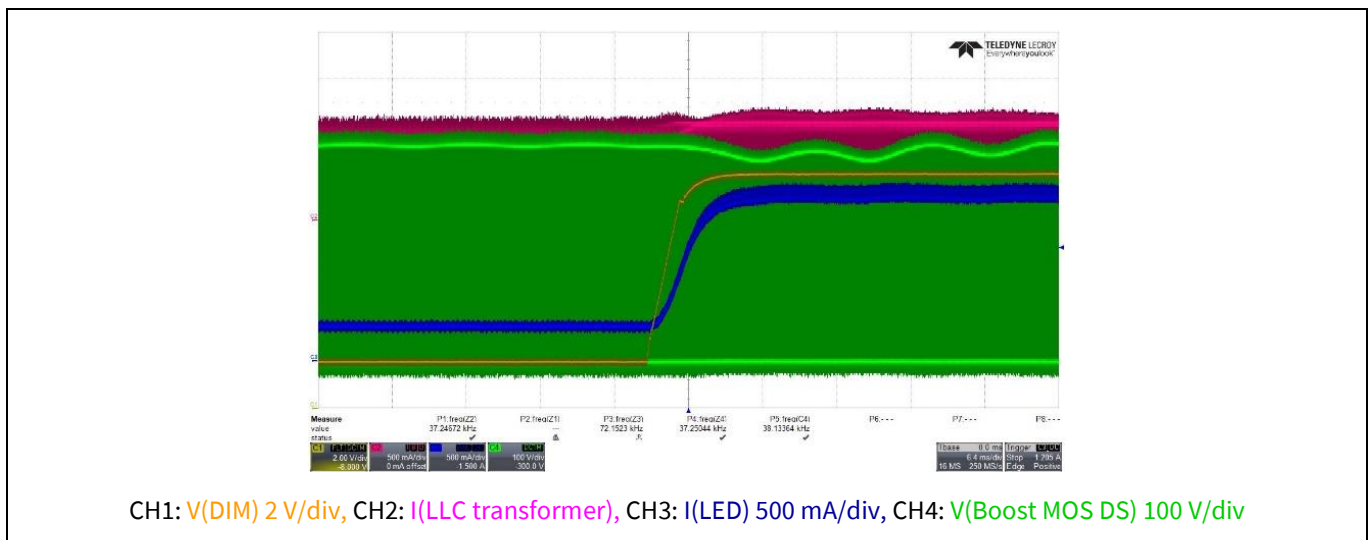

**Figure 21** LED current transient behavior when  $V_{dim}$  jumps from 0.1 V to 10 V

# 130 W PFC + LLC LED driver design based on ICL5102

## 1 percent dimming with wide LED voltage and an integrated LLC transformer

### Electrical performance

### 3.5 Protections

#### 3.5.1 Brown-out protection

The external resistors and capacitors around the brown-out pin are tuned such that the brown-out protection is triggered around 83 V<sub>RMS</sub> and brown-in around 90 V<sub>RMS</sub>.

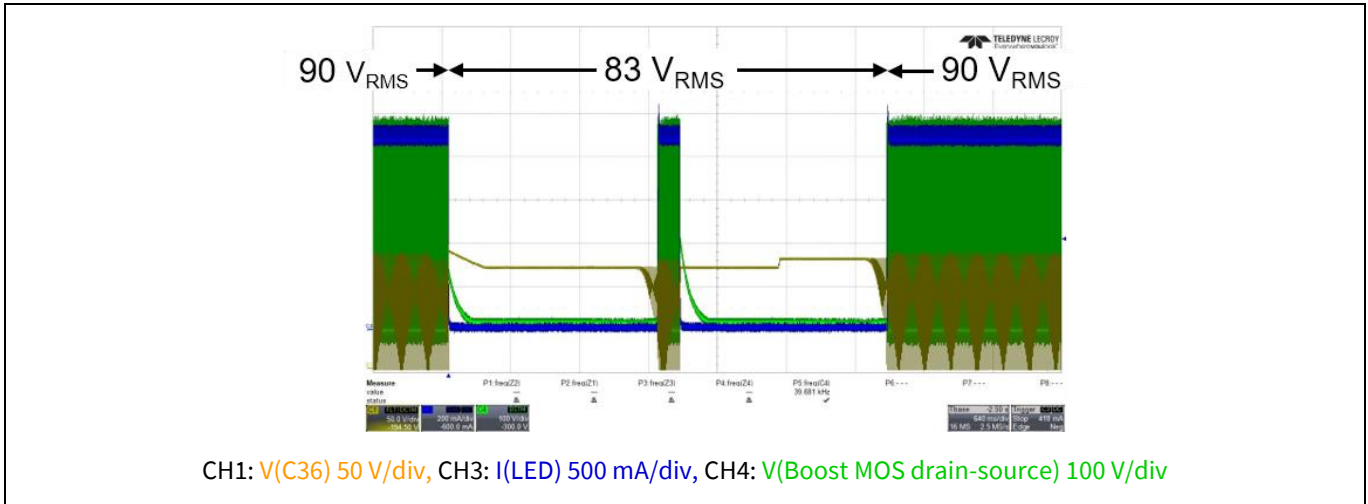

**Figure 22** Brown-out protection (brown-out point at 83 V<sub>RMS</sub>)

#### 3.5.2 Open load protection

The OVP pin is used for output overvoltage protection. **Figure 23** shows the waveforms when the LED load is disconnected and the OVP function shuts down the IC once the overvoltage is detected. During the OVP phase, the external start-up circuit is activated repeatedly but the overall system average power consumption is kept below 0.4 W.

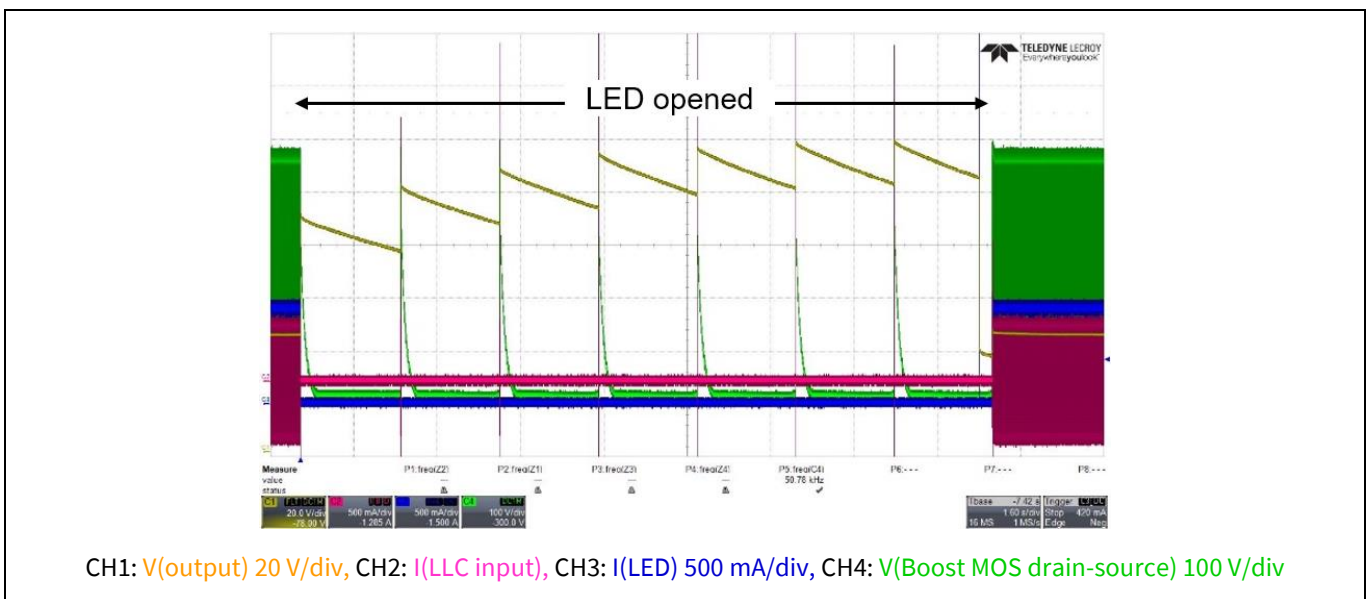

**Figure 23** LED open protection



# 130 W PFC + LLC LED driver design based on ICL5102

## 1 percent dimming with wide LED voltage and an integrated LLC transformer

### Thermal performance

#### 4 Thermal performance

The temperature profiles of this open-frame board at 120 V<sub>RMS</sub> and 230 V<sub>RMS</sub>, full load are presented in [Figure 24](#) and [Figure 25](#). The room temperature is 22°C. It can be found that the output diodes and the LLC transformer are around 80°C in the worst case. Here, the copper plane area of the output diodes can be extended for further cooling. The hottest component is the rectifier diode bridge (86°C) at 120 V<sub>RMS</sub> input and 130 W output power. A diode bridge with higher current rating and better cooling package can be used to bring down its temperature rise.

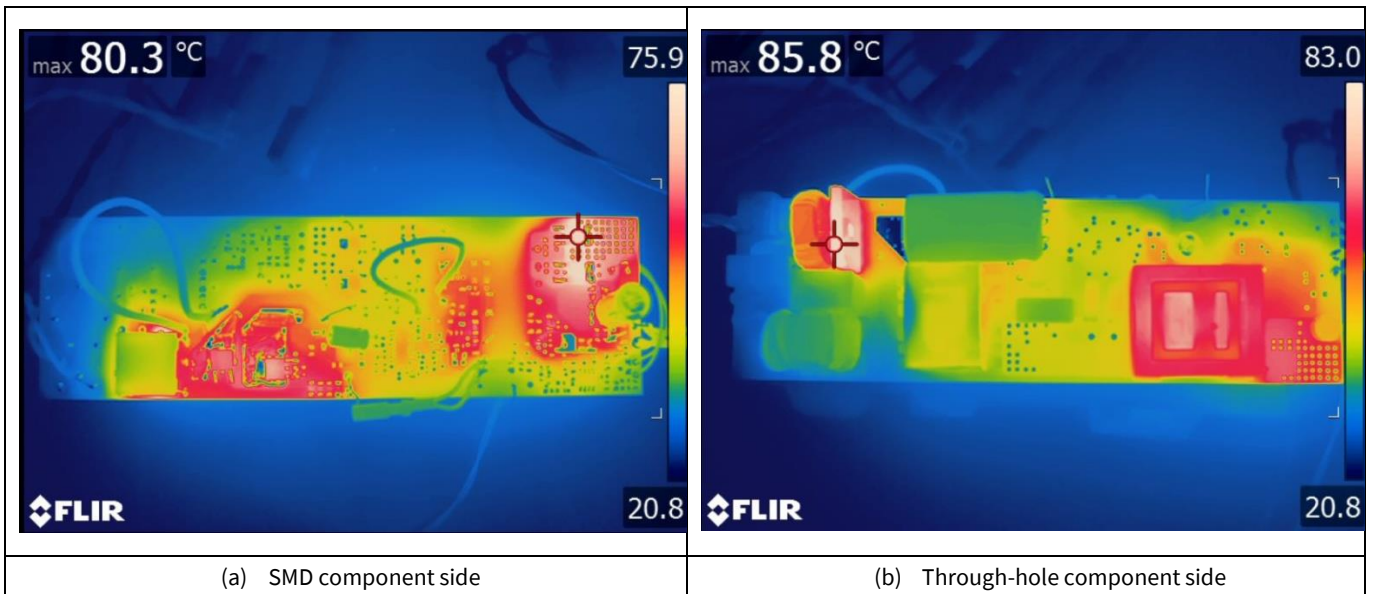

**Figure 24** Infrared images at 120 V<sub>RMS</sub>, 76 V<sub>LED</sub> and 130 W

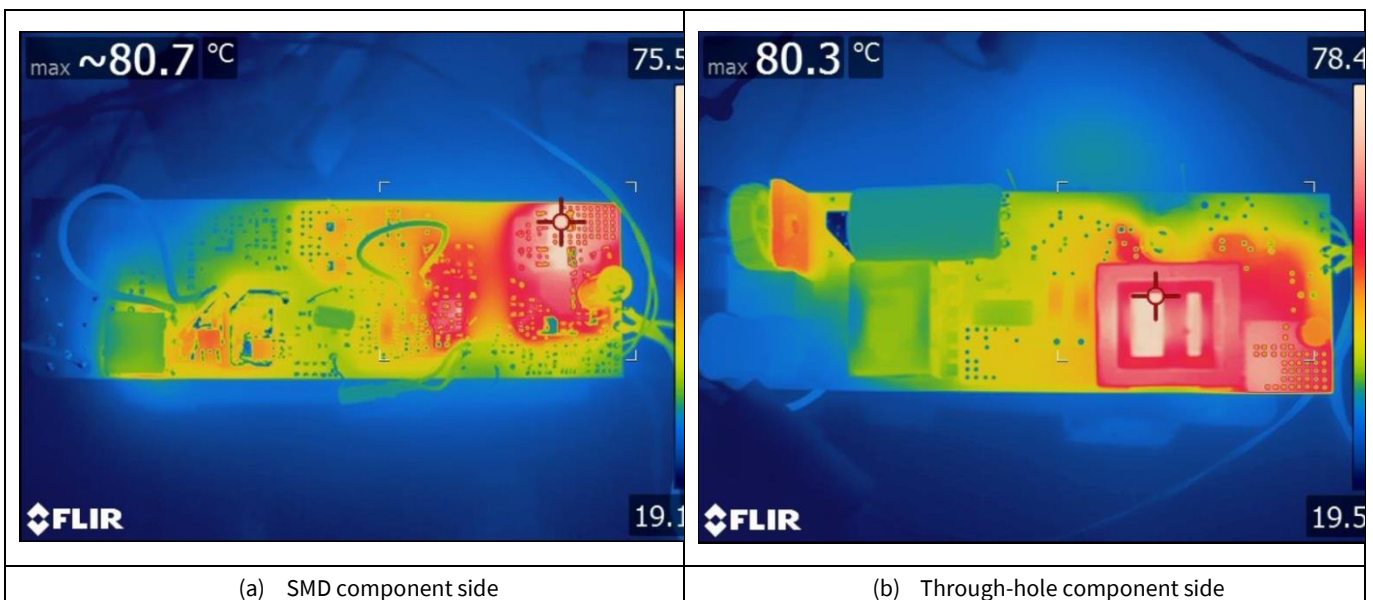
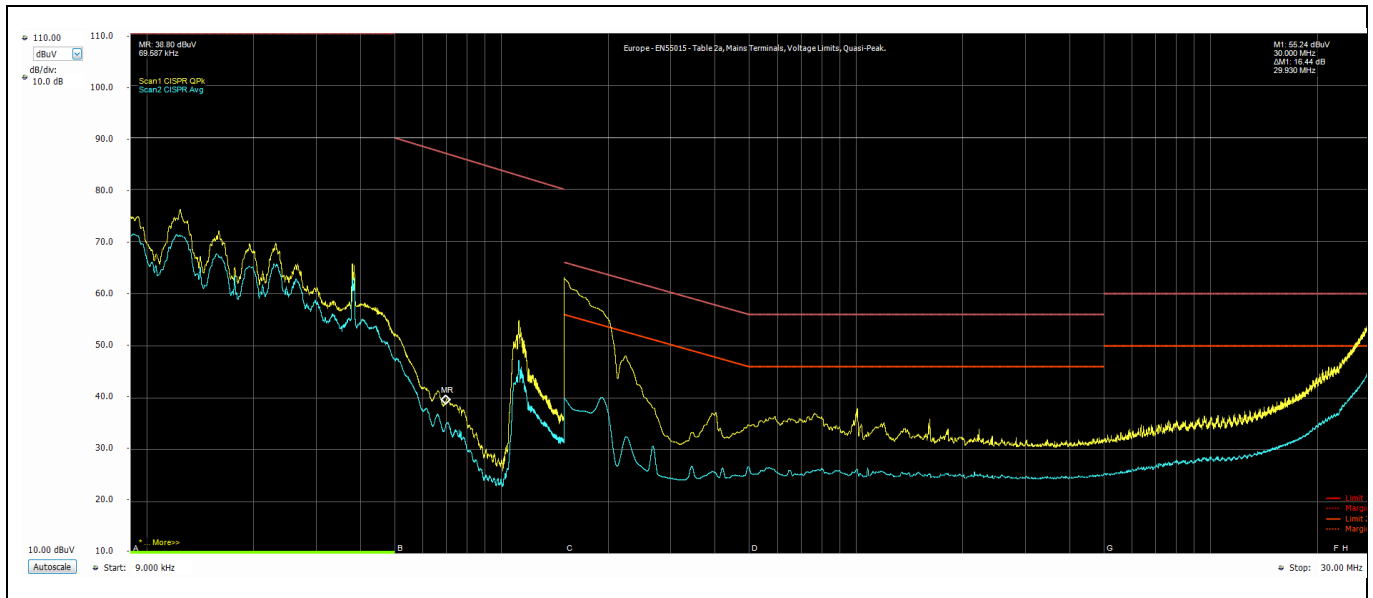

**Figure 25** Infrared images at 230 V<sub>RMS</sub>, 76 V<sub>LED</sub> and 130 W

**EMI performance**

**5 EMI performance**

The conducted EMI performance (9 kHz to 30 MHz) has been measured at 230 V<sub>RMS</sub> input with full (Figure 26). Note that these tests are conducted with this open-frame board and with its protective earth connected to the earth of the LISN.



**Figure 26** Conducted EMI at 230 V<sub>RMS</sub> input and 130 W output

## 6 Datasheets of magnetic components

The datasheets of all magnetic components are shown below.

		<b>DATASHEET</b>		12/10/2020	<b>REV</b>	00
		<b>EDITED</b>		Davide Maida	<b>APPROVED</b>	Dario Radaelli
<b>FINAL P/N</b>	SCT2213223	<b>REV</b>	00	<b>SAMPLING CODE</b>	SCT2213223-19.0394	
<b>PRELIMINARY P/N</b>	OP2010012			<b>CUSTOMER P/N</b>		
<b>CUSTOMER</b>	INFINEON TECHNOLOGIES AG (Munich)					

  

<b>DESCRIPTION</b>	Common mode inductor 2 x 22mH 2,3A		
--------------------	------------------------------------	--	--

<b>TEST/FEATURES</b>			
Inductance L1	>15,4mH	@10KHz 100mV	
Leakage Inductance L1	147uH typ	@100KHz 1V	L2 shorted
DCR L1=L2	185mΩ typ		
Nominal current	2,3A		
Mains rated voltage	250V		
Turns Ratio L1:L2	1:1		
Dielectric Strength	L1/L2	1,5KV/2"	

<b>LAYOUT (bottom view)</b>	<b>DRAWING</b>
	

<b>DIMENSIONS (mm)</b>					
<b>A</b>	27,4 max	<b>B</b>	18,7 max	<b>H</b>	30,9 max
<b>L</b>	3,5 min	<b>D</b>	1,0 typ	<b>Y</b>	12,0 typ
				<b>X</b>	10,0 typ

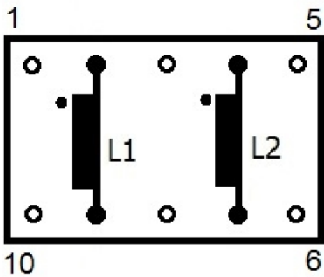
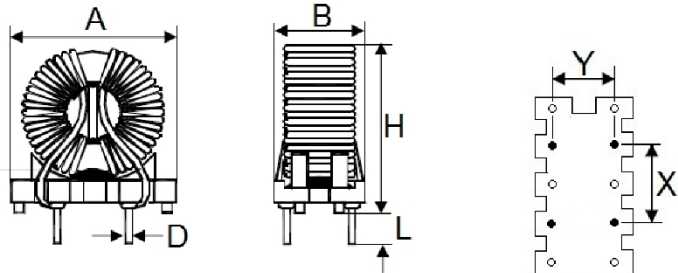
<b>NOTES</b>
RoHS compliant [Directives 2011/65/EU and 2015/863/EU] see <a href="https://www.itacoilweb.com/files/RoHS.pdf">https://www.itacoilweb.com/files/RoHS.pdf</a>
REACH compliant [Regulation (EC)1907/2006] see <a href="https://www.itacoilweb.com/regulatory-compliance/">https://www.itacoilweb.com/regulatory-compliance/</a>
Your use of the data herein constitutes your acceptance of the terms and conditions set forth in the Disclaimer at following link: <a href="https://www.itacoilweb.com/files/DISCLAIMER.pdf">https://www.itacoilweb.com/files/DISCLAIMER.pdf</a>
Your use of the Products of Itacoil constitutes your acceptance of the terms and conditions set forth in the General Technical Notes at the link below. The General Terms of Sale are those stated at following link and they will govern every sale of Products. English version (for foreign Customers): <a href="https://www.itacoilweb.com/files/CGV_ENG_sales_conditions.pdf">https://www.itacoilweb.com/files/CGV_ENG_sales_conditions.pdf</a> Italian version (for italian Customers): <a href="https://www.itacoilweb.it/files/CGV_ITA_condizioni_vendita.pdf">https://www.itacoilweb.it/files/CGV_ITA_condizioni_vendita.pdf</a>

**Figure 27 Common mode EMI choke – L2A**

**130 W PFC + LLC LED driver design based on ICL5102**  
**1 percent dimming with wide LED voltage and an integrated LLC transformer**  
**Datasheets of magnetic components**



		<b>DATASHEET</b>		14/04/2021	<b>REV</b>	01		
		<b>EDITED</b>		Davide Maida	<b>APPROVED</b>	Dario Radaelli		
<b>FINAL P/N</b>	TOR179	<b>REV</b>	00	<b>SAMPLING CODE</b>				
<b>PRELIMINARY P/N</b>	OP2010013			<b>CUSTOMER P/N</b>				
<b>CUSTOMER</b>	INFINEON TECHNOLOGIES AG (Munich)							
<b>DESCRIPTION</b>		Inductance 415uH						
<b>TEST/FEATURES</b>								
Inductance A1	415,0 $\mu$ H $\pm$ 10,0%		1KHz-100mV					
DCR A1	255,0 m $\Omega$ $\pm$ 15,0%							
<b>LAYOUT (bottom view)</b>			<b>DRAWING</b>					
<b>DIMENSIONS (mm)</b>								
<b>A</b>	25,0 max	<b>B</b>	11,5 max	<b>H</b>	22,5 max	<b>D<math>\phi</math></b>	1,0 typ	
<b>X</b>	7,5 typ	<b>Y</b>	6,0 typ				<b>L</b>	2,5 min
<b>NOTES</b>								
RoHS compliant [Directives 2011/65/EU and 2015/863/EU] see <a href="https://www.itacoilweb.com/files/RoHS.pdf">https://www.itacoilweb.com/files/RoHS.pdf</a>								
REACH compliant [Regulation (EC)1907/2006] see <a href="https://www.itacoilweb.com/regulatory-compliance/">https://www.itacoilweb.com/regulatory-compliance/</a>								
<p>Your use of the data herein constitutes your acceptance of the terms and conditions set forth in the Disclaimer at following link:  <a href="https://www.itacoilweb.com/files/DISCLAIMER.pdf">https://www.itacoilweb.com/files/DISCLAIMER.pdf</a></p> <p>Your use of the Products of Itacoil constitutes your acceptance of the terms and conditions set forth in the General Technical Notes at the link below.  The General Terms of Sale are those stated at following link and they will govern every sale of Products.  English version (for foreign Customers): <a href="https://www.itacoilweb.com/files/CGV_ENG_sales_conditions.pdf">https://www.itacoilweb.com/files/CGV_ENG_sales_conditions.pdf</a>  Italian version (for Italian Customers): <a href="https://www.itacoilweb.it/files/CGV_ITA_condizioni_vendita.pdf">https://www.itacoilweb.it/files/CGV_ITA_condizioni_vendita.pdf</a></p>								

**Figure 28 Differential mode EMI choke – L1**

**130 W PFC + LLC LED driver design based on ICL5102**  
**1 percent dimming with wide LED voltage and an integrated LLC transformer**  
**Datasheets of magnetic components**

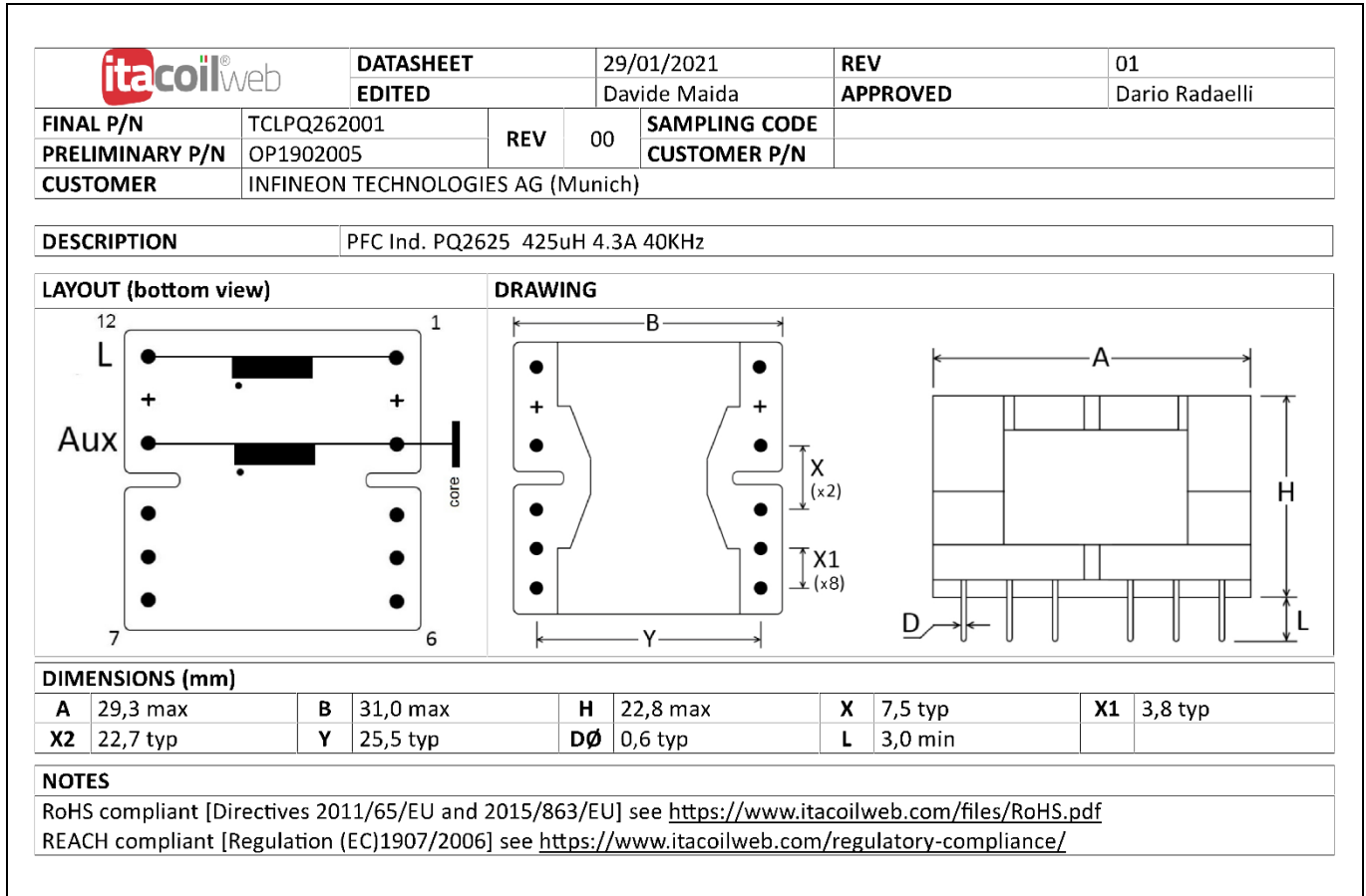

**Figure 29 Boost inductor – L6**

**130 W PFC + LLC LED driver design based on ICL5102**  
**1 percent dimming with wide LED voltage and an integrated LLC transformer**  
**Datasheets of magnetic components**



<b>itacoilweb</b>		<b>DATASHEET</b>		10/09/2020		<b>REV</b>		02	
		<b>EDITED</b>		Davide Maida		<b>APPROVED</b>		Dario Radaelli	
<b>FINAL P/N</b>	TRLEV3001	<b>REV</b>	01	<b>SAMPLING CODE</b>					
<b>PRELIMINARY P/N</b>	OP1902006			<b>CUSTOMER P/N</b>					
<b>CUSTOMER</b>	INFINEON TECHNOLOGIES AG (Munich)								

<b>DESCRIPTION</b>	LLC transf. for REF-ICL5102-U130W-C		
<b>TEST/FEATURES</b>			
Inductance Pri	3000 $\mu$ H $\pm$ 8,0%	100KHz / 1V	
Leakage Inductance Pri	799,0 $\mu$ H $\pm$ 10,0%	100KHz/1V	Sec.1 shorted
Leakage Inductance Pri	799,0 $\mu$ H $\pm$ 10,0%	100KHz/1V	Sec.2 shorted
Dielectric Strenght	Pri+AuxP / Sec1+Sec2+AuxS	4,0KVac /2sec.	
Dielectric Strenght	Pri / AuxP	750Vac /2sec.	
Turns ratio	Sec1:Pri:Sec2:AuxP:AuxS	1:6,73:1:0,47:0,47	
Tank designer	ITACOIL		

<b>LAYOUT (bottom view)</b>	<b>DRAWING</b>

<b>DIMENSIONS (mm)</b>									
<b>A</b>	34,2 max	<b>B</b>	35,6 max	<b>H</b>	22,2 max	<b>L</b>	2,5 min	<b>D<math>\phi</math></b>	0,8 Typ
<b>X</b>	5,2 Typ	<b>Y</b>	28,5 Typ						

<b>COMPONENT</b>	<b>THERMAL CLASS</b>
Bobbin	150°C (B)
Enamelled Wire	155°C (F)
TIW Wire	130°C (B)
Shell	140°C (B)
Tape	130°C (B)
Tube	200°C (N)
Varnish	155°C (H)

**NOTES**  
 REACH & RoHS compliant

By using the data in the technical documents of Itacoil (including but not limited to the website, full catalogues or their parts, datasheets and test reports) you accept the terms and conditions set forth in the document at the following link:

General Technical Notes (foreign countries) - rev. 1.00 2020/11/11 [https://www.itacoilweb.com/files/NTG\\_ENG\\_general\\_technical\\_notes.pdf](https://www.itacoilweb.com/files/NTG_ENG_general_technical_notes.pdf)

Note Tecniche Generali (Italia) - rev. 1.00 11/11/2020 [https://www.itacoilweb.it/files/NTG\\_ITA\\_note\\_tecniche\\_generali.pdf](https://www.itacoilweb.it/files/NTG_ITA_note_tecniche_generali.pdf)

ST1 - ENG rev. 08 - 10/11/2020	all rights reserved	subject to change without notice
1ST ITALIAN MANUFACTURER OF PCB TRANSFORMERS WITH ISO CERTIFIED QUALITY MANAGEMENT SYSTEM		
I T A C O I L s.r.l. • via delle Gerole, 7 • I-20867 CAPONAGO (MB) Tel. +39 02 95745131 • Fax +39 02 95745133 e-mail <a href="mailto:contatto@itacoilmail.it">contatto@itacoilmail.it</a> • <a href="http://www.itacoilweb.com">www.itacoilweb.com</a> Cap. soc. Euro 81600 i.v. • p.IVA, cod.fisc., N° reg.impr.MI 03071100964	Quality System UNI EN ISO 9001 Certified CEI Member Italian and Asian production sites Powered by zero impact® renewable energy	

**Figure 30 Integrated LLC transformer – TR1**

## Bill of materials

## 7 Bill of materials

Qty	Designator	Description	Manufacturer	MPN
1	1 to 10 V	Violet cable/CON-F-THT-SSW-101-02-S-S	Manufacturer	
1	BR1	GBU807/1000 V/SIP-4	Taiwan Semiconductor	GBU807
2	C1, C3	Capacitor 220 nF/305 V AC/radial type/10%	Epcos	B32922C3224K
1	C1A	Capacitor 330 nF/630 V/radial type/20%	TDK Corporation	B32922C3334M189
5	C4, C9, C13, C21, C23	Capacitor 100 n/50 V/0805/X7R/10%	TDK	C2012X7R1H104K085AA
1	C5	Capacitor 56 $\mu$ /500 V/ CAPPR750D80D1825H2700/20%	Nichicon	UCY2H560MHD
1	C6	Capacitor 2.2 n/50 V/0805/X7R/10%	KEMET	C0805C222K5RACTU
1	C7, C10	Capacitor 1 $\mu$ /50 V/1206/X7R/10%	TDK	C3216X7R1H105K160AB
1	C8	Capacitor 68 $\mu$ /35 V/ CAPPRD250W50D630H1220B/20%	Panasonic	EEUFR1V680
1	C11	Capacitor 22 n/50 V/0603/X7R/5%	Murata	GRM188R71H223JA01
1	C12	Capacitor 2.2 n/25 V/0603/C0G/5%	KEMET	C0603C222J3GACTU
1	C14	Capacitor 100 p/50 V DC/0805/C0G (EIA)/5%	Murata	GCM2165C1H101JA16#
1	C15	Capacitor 1.2 $\mu$ F/25 V/1206/X7R/10%	AVX	12063C224K4Z2A
1	C16	Capacitor 220 n/630 V DC/ CAPRR1500W80L1850T900H1750B/5%	Panasonic	ECQE6224JF
2	C19, C19A	Capacitor 4.7 n/1600 V/ CAPRR1000W60L1300T600H1200B/5%	TDK	B32671L0472J000
1	C20	Capacitor 2200 p/760 V AC/disk/pitch 10 to 15/Y5U/20%	Vishay	440LD22-R
1	C22	Capacitor 1 $\mu$ /50 V/1206/X7R/10%	TDK	C3216X7R1H105K160AB
1	C24	Capacitor 4.7 n/50 V/0805/C0G/5%	Murata	GRM2165C1H472JA01
1	C25	Capacitor 47 nF/50 V/0805/X7R/10%	Murata	GRM21BR71H473KA01
1	C28	Capacitor 56 n/50 V/0805/X7R/10%	Kemet	C0805C563K5RACTU
1	C29	Capacitor 2.2 $\mu$ F/25 V/1206/X7R/10%	Murata	GCM31MR71E225KA57
1	C30	Capacitor 100 p/50 V DC/0805/C0G (EIA)/5%	Murata	GCM2165C1H101JA16#
1	C31	Capacitor 330 n/50 V/0805/X7R/10%	AVX	08055C334K4Z2A
1	C32	Capacitor 100 $\mu$ F/200 V/ CAPPRD750W80D1625H1220B/20%	Vishay	MAL215262101E3
1	C33	Capacitor 1 n/50 V DC/0805/C0G (EIA)/5%	Murata	GCM2195C1H102JA16#
1	C34	Capacitor 470 nF/25 V/0603/X5R/10%	Murata	GRM188R61E474KA12
1	C35	Capacitor 100 n/25 V/0603/X7R/10%	KEMET	C0603C104K3RAC
1	C37	Capacitor 10 n/50 V DC/0805/C0G (EIA)/5%	Murata	GCM21B5C1H103JA16#
1	C50	Capacitor 4.7 nF/100 V/0805/X7R/10%	Murata	GRM216R72A472KAC4
1	C51	Capacitor 2.7 nF/100 V/0805/C0G/5%	Murata	GRM2165C2A272JA01
1	C52	Capacitor 100 $\mu$ F/50 V/WCAP- ATG8_D8H11.5	Würth Elektronik	
1	C60	Capacitor 2.2 $\mu$ /100 V/1206/X7R/10%	Murata	GRM31CR72A225KA73
1	C61	Capacitor 2.2 $\mu$ /100 V/1206/X7R/10%	Murata	GRM31CR72A225KA73
2	CY1, CY2	Capacitor 2200 p/760 V AC/ CAPRR950W81L1090T570H1410B/Y5U/20%	Vishay	440LD22-R
1	D4	STTH5L06B-TR/30 V/DPAK-3	STMicroelectronics	STTH5L06B-TR

# 130 W PFC + LLC LED driver design based on ICL5102

## 1 percent dimming with wide LED voltage and an integrated LLC transformer



### Bill of materials

1	D5	Diode 17 V/SOD-80C	Nexperia	TZM5247B-GS08CT
1	D6	1N4148W/100 V/SOD-123	Diodes Incorporated	1N4148W-7-F
1	D7	TZMB16/16 V/SOD-80C	Vishay	TZM5246B-GS18
5	D8, D50, D51, D52, D53	S100/100 V/DO-214AC (SMA)	Onsemi	S100
2	D9, D11	US1M/1000 V/DO-214AC (SMA)	Vishay	US1M-E3/61T
4	D10, D12, D13, D18	1N4148W/100 V/SOD-123	Diodes Incorporated	1N4148W-7-F
1	D15	Diode STTH802B-TR/DPAK	STMicroelectronics	STTH802B-TR
1	D16	Diode STTH802B-TR/DPAK	STMicroelectronics	STTH802B-TR
1	D17	BZT55B12/12 V/SOD-80C	Vishay	BZT55B12
1	D20	SS12HE3/20 V/DO-214AC	Vishay	SS12HE3_A/H
2	D21, D22	S1PM/1 kV/DO-220AA	Vishay	S1PM-M3/84A
1	F1	3.15 A/300 V/ FUSRR508W60L850T400H800B/	Littelfuse	36913150000
1	Glue pad	Glue pad	3M	4016-1/2"x36yd
1	GND	Gray cable/CON-F-THT-SSW-101-02-S-S	Manufacturer	
1	Heat shrink	Heat shrink	e.g., Alpha Wire	
<b>1</b>	<b>IC1</b>	<b>ICL5102/PG-DSO-16</b>	<b>Infineon</b>	<b>ICL5102</b>
1	IC2	LM358ADR/SOIC-8	Texas Instruments	LM358ADR
1	L1	Inductor 415 µH/THT	Itacoil	TOR179
1	L2	Inductor 44 mH/THT	Itacoil	SCT2213223
1	L6	Inductor 425 µH/THT	Itacoil	TCLPQ262001
1	O/P-	Black cable/CON-F-THT-SSW-101-02-S-S	Manufacturer	
1	O/P+	Red cable/CON-F-THT-SSW-101-02-S-S	Manufacturer	
1	PC1	SFH617A-3X007T/SMD-4, 1016LS254P650W458L440H	Vishay	SFH617A-3X007T
1	PCB	PCB		
<b>1</b>	<b>Q1A</b>	<b>BSS126/PG-SOT-23-3-5</b>	<b>Infineon</b>	<b>BSS126</b>
1	Q3	MMBT3904/SOT-23-3	NXP Semiconductors	MMBT3904,215
<b>1</b>	<b>Q4</b>	<b>Transistor IPD60R280PFS/PG-T0252-3</b>	<b>Infineon</b>	<b>IPD60R280P7S</b>
1	Q5	BCX56-16/SOT89	NXP	BCX56-16
<b>2</b>	<b>Q6, Q7</b>	<b>Transistor IPN60R360P7S/PG-SOT-223</b>	<b>Infineon</b>	<b>IPN60R360P7S</b>
1	Q8	BCX56-16/SOT-89	NXP	BCX56-16
2	R1, R2	Resistor 1.5 M/200 V/1206/1%	Yageo/Phycomp	RC1206FR-071M5L
6	R3, R3A, R4, R4A, R5, R5A	Resistor 18k/200 V/1206/1%	Vishay	CRCW120618K0FK
5	R6, R6A, R6B, R6C, R6D	Resistor 1R0/200 V/1206/1%	Panasonic	ERJ8RQF1R0 V
2	R7, R9	Resistor 20k/150 V/0805/1%	Yageo/Phycomp	RC0805FR-0720K
2	R8, R13	Resistor 0 R/150 V/0805/	Vishay	CRCW08050000Z0
2	R10, R38	Resistor 1.0k/150 V/0805/1%	Bourns	CR0805-FX-1001ELF
1	R11	Resistor 10 R/150 V/0805/1%	Vishay	CRCW080510R0FKEA
1	R12	Resistor 47k/150 V/0805/1%	Vishay	CRCW080547K0FKEA



# 130 W PFC + LLC LED driver design based on ICL5102

## 1 percent dimming with wide LED voltage and an integrated LLC transformer



### Bill of materials

2	R15, R16	Resistor 510k/150 V/0805/1%	Vishay	CRCW0805510KFKEA
1	R17	Resistor 43k/150 V/0805/1%	Vishay	CRCW080543K0FK
3	R18, R19, R20	Resistor 1.5 M/200 V/1206/1%	Yageo/Phycomp	RC1206FR-071M5L
1	R21	Resistor 24.9k/150 V/0805/1%	Vishay	CRCW080524K9FKEA
1	R22	Resistor 3k/200 V/1206/1%	Vishay	CRCW12063K00FKEA
1	R24	Resistor 11k/75 V/0603/1%	Vishay	CRCW060311K0FKEA
1	R25	Resistor 240k/75 V/0603/1%	Vishay	CRCW0603240KFK
1	R26	Resistor 56k/150 V/0805/1%	Vishay	CRCW080556K0FK
1	R27	Resistor 3.3k/75 V/0603/1%	Vishay	CRCW06033K30FK
1	R28	Resistor 2k/75 V/0603/1%	Vishay	CRCW06032K00FK
1	R29	NTC 100k/0805/5%	Epcos	B57471V2104J62
1	R30	Resistor 10 R/150 V/0805/1%	Vishay	CRCW080510R0FKEA
2	R31, R32	Resistor 22 R/150 V/0805/1%	Vishay	CRCW080522R0FKEA
4	R34, R34A, R34B, R34C	Resistor 1.2 R/200 V/1206/1%	Vishay	CRCW12061R20FK
2	R35, R36	Resistor 47k/150 V/0805/1%	Vishay	CRCW080547K0FKEA
1	R37	Resistor 330 R/150 V/0805/1%	Vishay	CRCW0805330RFKEA
1	R39	Resistor 3.3k/150 V/0805/1%	Vishay	CRCW08053K30FKEA
1	R40	Resistor 10 R/200 V/1206/1%	Vishay	CRCW120610R0FKEA
2	R41, R45	Resistor 3.6k/150 V/0805/1%	Vishay	CRCW08053K60FKEA
1	R42	Resistor 10k/150 V/0805/1%	Vishay	CRCW080510K0FK
2	R43, R56	Resistor 2.2M/200 V/1206/1%	Vishay	CRCW12062M20FKEA
1	R44	Resistor 20k/150 V/0805/1%	Vishay	CRCW080520K0FKEA
1	R46	Resistor 2.2 M/200 V/1206/1%	Vishay	CRCW12062M20FKEA
1	R47	Resistor 360k/150 V/0805/1%	Vishay	CRCW0805360KFKEA
1	R48	Resistor 3.9 M/150 V/0805/1%	Vishay	CRCW08053M90FKEA
1	R49	Resistor 4.3k/150 V/0805/1%	Vishay	CRCW08054K30FK
3	R50, R51, R52	Resistor 0.15 R/675 mV/1206/1%	Bourns	CRL1206-FW-R150ELF
1	R53	Resistor 2.0k/150 V/0805/1%	Vishay	CRCW08052K00FKEA
1	R54	Resistor 150k/200 V/1206/1%	Vishay	CRCW1206150KFKEA
1	R55	Resistor 33k/150 V/0805/1%	Vishay	CRCW080533K0FKEA
1	R57	Resistor 110k/75 V/0603/1%	Vishay	CRCW0603110KFK
1	R59	Resistor 3.6k/75 V/0603/1%	Vishay	CRCW06033K60FK
1	R62	Resistor 330k/150 V/0805/1%	Vishay	CRCW0805330KFKEA
1	TR1	Transistor TRLEV3001/THT	Itacoil	TRLEV3001
1	VR1	10D561K/560 V/ VARRR750W80L1300T500H1600B/10%	Bourns	MOV-10D561K
1	VR2	TL431CDBZR/2.495 V/SOT-23-3/	Texas Instruments	TL431CDBZR
1	X1	WAGO_250-203/WAGO_250-203/	WAGO	250-203
0	C10A	NA/25 V/CAPPRD250W50D630H1220B/20%	Würth Elektronik	860010473011
0	C17	NA/630 V DC/1206/X7R/10%	TDK	C3216X7R2J102K115AA
0	C18	NA/630 V DC/1206/X7R/10%	TDK	C3216X7R2J102K115AA
0	C36	NA/1206/X7R/10%	Murata	GRM31BR72J222KW01L
0	C53	NA/50 V/0805/X7R/10%	TDK	C2012X7R1H104K085AA
0	D1	NA/100 V/SOD-123	Diodes Incorporated	1N4148W-7-F
0	D2	NA/1000 V/DO-214AC (SMA)	Vishay	US1M-E3/61T

# 130 W PFC + LLC LED driver design based on ICL5102

## 1 percent dimming with wide LED voltage and an integrated LLC transformer



### Bill of materials

0	D3	NA/30 V/DO-214AB (SMC)	Vishay	S5J-E3/57T
0	R23	Resistor NA/200 V/1206/1%	Vishay	CRCW120610R0FK
0	R58	Resistor 33k/150 V/0805/1%	Vishay	CRCW080533K0FK
0	R60	NA/50 V/0603/1%	Yageo/Phycomp	RC0603FR-07K
0	R61	NA/75 V/0603/20 mΩ	Vishay	CRCW06030000Z0EA



**Revision history**

**Revision history**

<b>Document version</b>	<b>Date of release</b>	<b>Description of changes</b>
V 1.0	2021-08-30	First release

#### Trademarks

All referenced product or service names and trademarks are the property of their respective owners.

**Edition 2021-08-30**

**Published by**

**Infineon AG**

**81726 Munich, Germany**

**© 2022 Infineon AG.**

**All Rights Reserved.**

**Do you have a question about this document?**

**Email:** [erratum@infineon.com](mailto:erratum@infineon.com)

**Document reference**

**ER\_2104\_PL39\_2104\_123217**

#### IMPORTANT NOTICE

The information contained in this application note is given as a hint for the implementation of the product only and shall in no event be regarded as a description or warranty of a certain functionality, condition or quality of the product. Before implementation of the product, the recipient of this application note must verify any function and other technical information given herein in the real application. Infineon hereby disclaims any and all warranties and liabilities of any kind (including without limitation warranties of non-infringement of intellectual property rights of any third party) with respect to any and all information given in this application note.

The data contained in this document is exclusively intended for technically trained staff. It is the responsibility of customer's technical departments to evaluate the suitability of the product for the intended application and the completeness of the product information given in this document with respect to such application.

For further information on the product, technology, delivery terms and conditions and prices please contact your nearest Infineon office ([www.infineon.com](http://www.infineon.com)).

#### WARNINGS

Due to technical requirements products may contain dangerous substances. For information on the types in question please contact your nearest Infineon office.

Except as otherwise explicitly approved by Infineon in a written document signed by authorized representatives of Infineon, Infineon' products may not be used in any applications where a failure of the product or any consequences of the use thereof can reasonably be expected to result in personal injury.