

## EconoPACK™3 module with TRENCHSTOP™ IGBT7 and emitter controlled 7 diode and NTC

### Features

- Electrical features
  - $V_{CES} = 1200\text{ V}$
  - $I_{C\text{nom}} = 150\text{ A} / I_{CRM} = 300\text{ A}$
  - Low  $V_{CE,sat}$
  - Overload operation up to  $175^\circ\text{C}$
  - TRENCHSTOP™ IGBT7
- Mechanical features
  - Integrated NTC temperature sensor
  - High power and thermal cycling capability
  - Solder contact technology
  - $\text{Al}_2\text{O}_3$  substrate with low thermal resistance
  - Copper base plate



### Potential applications

- Motor drives
- Auxiliary inverters
- Servo drives

### Product validation

- Qualified for industrial applications according to the relevant tests of IEC 60747, 60749 and 60068

### Description

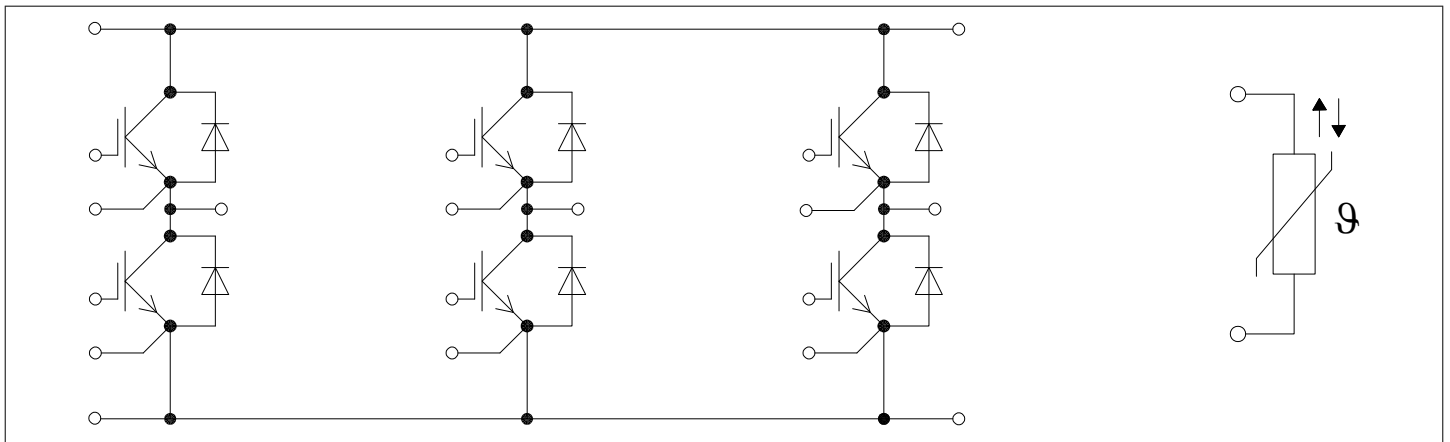

## Table of contents

	<b>Description</b> .....	1
	<b>Features</b> .....	1
	<b>Potential applications</b> .....	1
	<b>Product validation</b> .....	1
	<b>Table of contents</b> .....	2
<b>1</b>	<b>Package</b> .....	3
<b>2</b>	<b>IGBT, Inverter</b> .....	3
<b>3</b>	<b>Diode, Inverter</b> .....	5
<b>4</b>	<b>NTC-Thermistor</b> .....	6
<b>5</b>	<b>Characteristics diagrams</b> .....	7
<b>6</b>	<b>Circuit diagram</b> .....	12
<b>7</b>	<b>Package outlines</b> .....	13
<b>8</b>	<b>Module label code</b> .....	14
	<b>Revision history</b> .....	15
	<b>Disclaimer</b> .....	16

## 1 Package

**Table 1** Insulation coordination

Parameter	Symbol	Note or test condition	Values	Unit
Isolation test voltage	$V_{ISOL}$	RMS, $f = 50 \text{ Hz}$ , $t = 1 \text{ min}$	2.5	kV
Material of module baseplate			Cu	
Internal isolation		basic insulation (class 1, IEC 61140)	$Al_2O_3$	
Creepage distance	$d_{Creep}$	terminal to heatsink	10.0	mm
Clearance	$d_{Clear}$	terminal to heatsink	7.5	mm
Comparative tracking index	$CTI$		>200	
Relative thermal index (electrical)	$RTI$	housing	140	°C

**Table 2** Characteristic values

Parameter	Symbol	Note or test condition	Values			Unit
			Min.	Typ.	Max.	
Stray inductance module	$L_{SCE}$			34		nH
Module lead resistance, terminals - chip	$R_{CC'+EE'}$	$T_C = 25^\circ\text{C}$ , per switch		1.6		mΩ
Storage temperature	$T_{stg}$		-40		125	°C
Mounting torque for module mounting	$M$	- Mounting according to valid application note	M5, Screw	3	6	Nm
Weight	$G$			300		g

Note: The current under continuous operation is limited to 50 A rms per connector pin.

## 2 IGBT, Inverter

**Table 3** Maximum rated values

Parameter	Symbol	Note or test condition	Values	Unit
Collector-emitter voltage	$V_{CES}$	$T_{vj} = 25^\circ\text{C}$	1200	V
Continuous DC collector current	$I_{CDC}$	$T_{vj \text{ max}} = 175^\circ\text{C}$ $T_C = 85^\circ\text{C}$	150	A
Repetitive peak collector current	$I_{CRM}$	$t_p = 1 \text{ ms}$	300	A
Gate-emitter peak voltage	$V_{GES}$		±20	V

**Table 4** Characteristic values

Parameter	Symbol	Note or test condition	Values			Unit
			Min.	Typ.	Max.	
Collector-emitter saturation voltage	$V_{CE\ sat}$	$I_C = 150\ A, V_{GE} = 15\ V$	$T_{vj} = 25\ ^\circ C$	1.55	1.80	V
			$T_{vj} = 125\ ^\circ C$	1.69		
			$T_{vj} = 175\ ^\circ C$	1.77		
Gate threshold voltage	$V_{GEth}$	$I_C = 3.5\ mA, V_{CE} = V_{GE}, T_{vj} = 25\ ^\circ C$	5.15	5.80	6.45	V
Gate charge	$Q_G$	$V_{GE} = \pm 15\ V, V_{CE} = 600\ V$		2.5		$\mu C$
Internal gate resistor	$R_{Gint}$	$T_{vj} = 25\ ^\circ C$		1		$\Omega$
Input capacitance	$C_{ies}$	$f = 100\ kHz, T_{vj} = 25\ ^\circ C, V_{CE} = 25\ V, V_{GE} = 0\ V$		30.1		nF
Reverse transfer capacitance	$C_{res}$	$f = 100\ kHz, T_{vj} = 25\ ^\circ C, V_{CE} = 25\ V, V_{GE} = 0\ V$		0.105		nF
Collector-emitter cut-off current	$I_{CES}$	$V_{CE} = 1200\ V, V_{GE} = 0\ V$	$T_{vj} = 25\ ^\circ C$		0.012	mA
Gate-emitter leakage current	$I_{GES}$	$V_{CE} = 0\ V, V_{GE} = 20\ V, T_{vj} = 25\ ^\circ C$			100	nA
Turn-on delay time (inductive load)	$t_{don}$	$I_C = 150\ A, V_{CE} = 600\ V, V_{GE} = \pm 15\ V, R_{Gon} = 3.6\ \Omega$	$T_{vj} = 25\ ^\circ C$	0.175		$\mu s$
			$T_{vj} = 125\ ^\circ C$	0.189		
			$T_{vj} = 175\ ^\circ C$	0.213		
Rise time (inductive load)	$t_r$	$I_C = 150\ A, V_{CE} = 600\ V, V_{GE} = \pm 15\ V, R_{Gon} = 3.6\ \Omega$	$T_{vj} = 25\ ^\circ C$	0.064		$\mu s$
			$T_{vj} = 125\ ^\circ C$	0.069		
			$T_{vj} = 175\ ^\circ C$	0.070		
Turn-off delay time (inductive load)	$t_{doff}$	$I_C = 150\ A, V_{CE} = 600\ V, V_{GE} = \pm 15\ V, R_{Goff} = 3.6\ \Omega$	$T_{vj} = 25\ ^\circ C$	0.323		$\mu s$
			$T_{vj} = 125\ ^\circ C$	0.409		
			$T_{vj} = 175\ ^\circ C$	0.443		
Fall time (inductive load)	$t_f$	$I_C = 150\ A, V_{CE} = 600\ V, V_{GE} = \pm 15\ V, R_{Goff} = 3.6\ \Omega$	$T_{vj} = 25\ ^\circ C$	0.094		$\mu s$
			$T_{vj} = 125\ ^\circ C$	0.205		
			$T_{vj} = 175\ ^\circ C$	0.275		
Turn-on energy loss per pulse	$E_{on}$	$I_C = 150\ A, V_{CE} = 600\ V, L_\sigma = 35\ nH, V_{GE} = \pm 15\ V, R_{Gon} = 3.6\ \Omega, di/dt = 1680\ A/\mu s (T_{vj} = 175\ ^\circ C)$	$T_{vj} = 25\ ^\circ C$	20.5		mJ
			$T_{vj} = 125\ ^\circ C$	26.9		
			$T_{vj} = 175\ ^\circ C$	30.9		
Turn-off energy loss per pulse	$E_{off}$	$I_C = 150\ A, V_{CE} = 600\ V, L_\sigma = 35\ nH, V_{GE} = \pm 15\ V, R_{Goff} = 3.6\ \Omega, dv/dt = 3200\ V/\mu s (T_{vj} = 175\ ^\circ C)$	$T_{vj} = 25\ ^\circ C$	9.95		mJ
			$T_{vj} = 125\ ^\circ C$	16.5		
			$T_{vj} = 175\ ^\circ C$	19.9		
SC data	$I_{SC}$	$V_{GE} \leq 15\ V, V_{CC} = 800\ V, V_{CEmax} = V_{CES} - L_{SCE} * di/dt$	$t_p \leq 8\ \mu s, T_{vj} = 150\ ^\circ C$	530		A
			$t_p \leq 7\ \mu s, T_{vj} = 175\ ^\circ C$	500		

(table continues...)

**Table 4 (continued) Characteristic values**

Parameter	Symbol	Note or test condition	Values			Unit
			Min.	Typ.	Max.	
Thermal resistance, junction to case	$R_{thJC}$	per IGBT			0.290	K/W
Thermal resistance, case to heat sink	$R_{thCH}$	per IGBT, $\lambda_{grease} = 1 \text{ W}/(\text{m}^2\text{K})$		0.0680		K/W
Temperature under switching conditions	$T_{vj\text{op}}$		-40		175	°C

Note:  $T_{vj\text{op}} > 150 \text{ °C}$  is only allowed for operation at overload conditions. For detailed specifications please refer to AN 2018-14.

### 3 Diode, Inverter

**Table 5 Maximum rated values**

Parameter	Symbol	Note or test condition	Values	Unit	
Repetitive peak reverse voltage	$V_{RRM}$	$T_{vj} = 25 \text{ °C}$	1200	V	
Continuous DC forward current	$I_F$		150	A	
Repetitive peak forward current	$I_{FRM}$	$t_p = 1 \text{ ms}$	300	A	
$I^2t$ - value	$I^2t$	$t_p = 10 \text{ ms}, V_R = 0 \text{ V}$	$T_{vj} = 125 \text{ °C}$	3240	$\text{A}^2\text{s}$
			$T_{vj} = 175 \text{ °C}$	2660	

**Table 6 Characteristic values**

Parameter	Symbol	Note or test condition	Values			Unit	
			Min.	Typ.	Max.		
Forward voltage	$V_F$	$I_F = 150 \text{ A}, V_{GE} = 0 \text{ V}$	$T_{vj} = 25 \text{ °C}$		1.72	2.10	V
			$T_{vj} = 125 \text{ °C}$		1.59		
			$T_{vj} = 175 \text{ °C}$		1.52		
Peak reverse recovery current	$I_{RM}$	$V_R = 600 \text{ V}, I_F = 150 \text{ A}, V_{GE} = -15 \text{ V}, -di_F/dt = 1680 \text{ A}/\mu\text{s} (T_{vj} = 175 \text{ °C})$	$T_{vj} = 25 \text{ °C}$		64.2		A
			$T_{vj} = 125 \text{ °C}$		86		
			$T_{vj} = 175 \text{ °C}$		98.9		
Recovered charge	$Q_r$	$V_R = 600 \text{ V}, I_F = 150 \text{ A}, V_{GE} = -15 \text{ V}, -di_F/dt = 1680 \text{ A}/\mu\text{s} (T_{vj} = 175 \text{ °C})$	$T_{vj} = 25 \text{ °C}$		9.61		$\mu\text{C}$
			$T_{vj} = 125 \text{ °C}$		20.1		
			$T_{vj} = 175 \text{ °C}$		27.7		

(table continues...)

**Table 6 (continued) Characteristic values**

Parameter	Symbol	Note or test condition	Values			Unit
			Min.	Typ.	Max.	
Reverse recovery energy	$E_{rec}$	$V_R = 600\text{ V}$ , $I_F = 150\text{ A}$ , $V_{GE} = -15\text{ V}$ , $-di_F/dt = 1680\text{ A}/\mu\text{s}$ ( $T_{vj} = 175\text{ °C}$ )	$T_{vj} = 25\text{ °C}$	2.62		mJ
			$T_{vj} = 125\text{ °C}$	6.07		
			$T_{vj} = 175\text{ °C}$	8.86		
Thermal resistance, junction to case	$R_{thJC}$	per diode			0.464	K/W
Thermal resistance, case to heat sink	$R_{thCH}$	per diode, $\lambda_{grease} = 1\text{ W}/(\text{m}^*\text{K})$		0.0700		K/W
Temperature under switching conditions	$T_{vj\text{ op}}$		-40		175	°C

Note:  $T_{vj\text{ op}} > 150\text{ °C}$  is only allowed for operation at overload conditions. For detailed specifications please refer to AN 2018-14.

## 4 NTC-Thermistor

**Table 7 Characteristic values**

Parameter	Symbol	Note or test condition	Values			Unit
			Min.	Typ.	Max.	
Rated resistance	$R_{25}$	$T_{NTC} = 25\text{ °C}$		5		kΩ
Deviation of $R_{100}$	$\Delta R/R$	$T_{NTC} = 100\text{ °C}$ , $R_{100} = 493\text{ }\Omega$	-5		5	%
Power dissipation	$P_{25}$	$T_{NTC} = 25\text{ °C}$			20	mW
B-value	$B_{25/50}$	$R_2 = R_{25} \exp[B_{25/50}(1/T_2 - 1/(298,15\text{ K}))]$		3375		K
B-value	$B_{25/80}$	$R_2 = R_{25} \exp[B_{25/80}(1/T_2 - 1/(298,15\text{ K}))]$		3411		K
B-value	$B_{25/100}$	$R_2 = R_{25} \exp[B_{25/100}(1/T_2 - 1/(298,15\text{ K}))]$		3433		K

Note: Specification according to the valid application note.

## 5 Characteristics diagrams

**Output characteristic (typical), IGBT, Inverter**

$I_C = f(V_{CE})$   
 $V_{GE} = 15 \text{ V}$

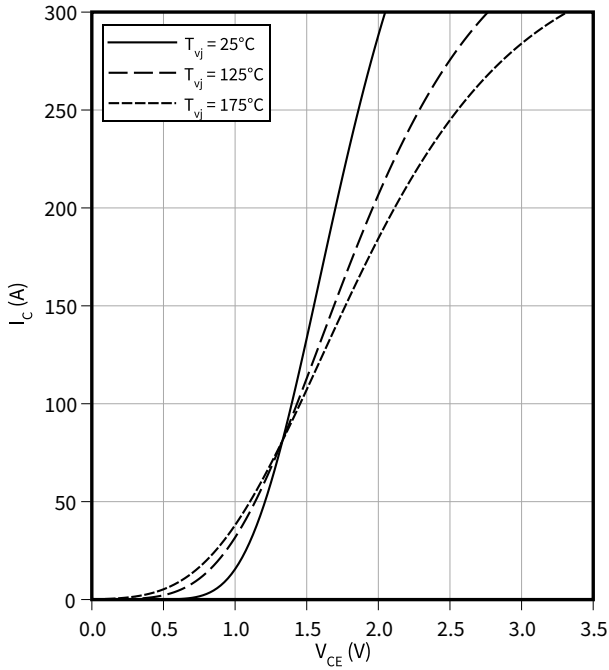

**Output characteristic field (typical), IGBT, Inverter**

$I_C = f(V_{CE})$   
 $T_{vj} = 175 \text{ °C}$

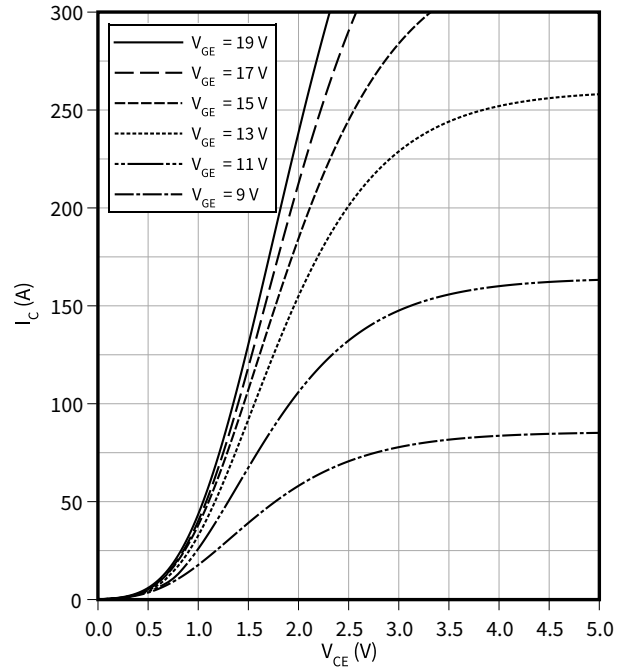

**Transfer characteristic (typical), IGBT, Inverter**

$I_C = f(V_{GE})$   
 $V_{CE} = 20 \text{ V}$

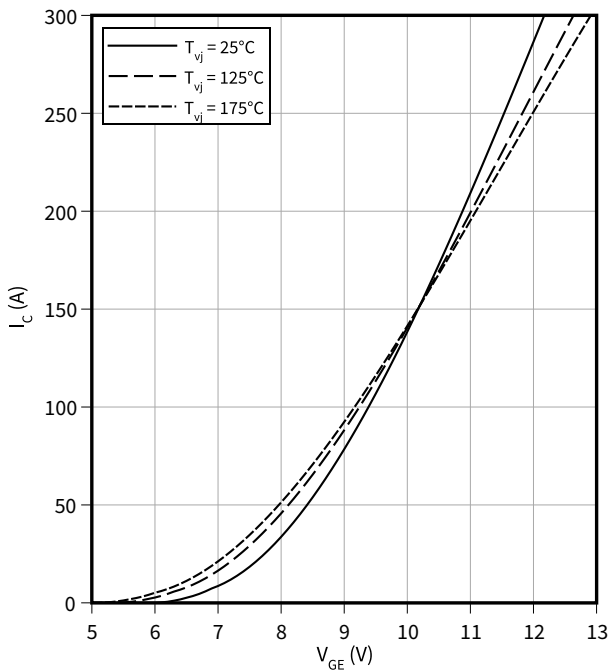

**Switching losses (typical), IGBT, Inverter**

$E = f(I_C)$   
 $R_{Goff} = 3.6 \text{ } \Omega$ ,  $R_{Gon} = 3.6 \text{ } \Omega$ ,  $V_{CE} = 600 \text{ V}$ ,  $V_{GE} = \pm 15 \text{ V}$

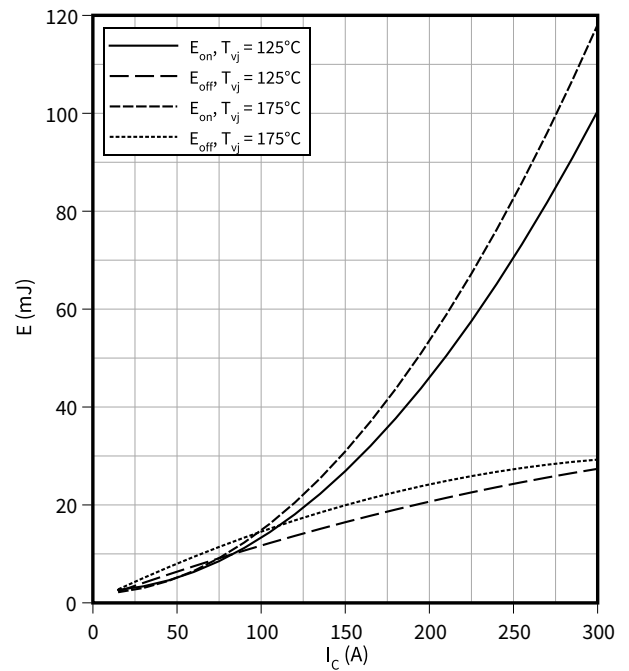

5 Characteristics diagrams

**Switching losses (typical), IGBT, Inverter**

$E = f(R_G)$

$I_C = 150 \text{ A}$ ,  $V_{CE} = 600 \text{ V}$ ,  $V_{GE} = \pm 15 \text{ V}$

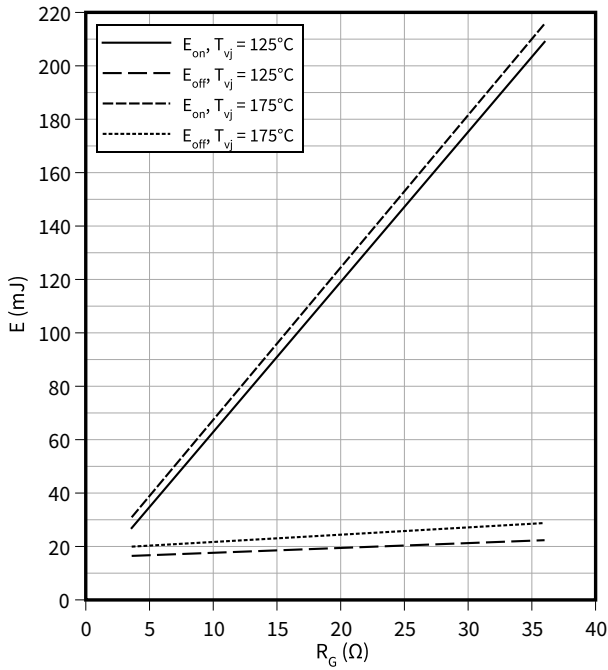

**Switching times (typical), IGBT, Inverter**

$t = f(I_C)$

$R_{Goff} = 3.6 \Omega$ ,  $R_{Gon} = 3.6 \Omega$ ,  $V_{CE} = 600 \text{ V}$ ,  $V_{GE} = \pm 15 \text{ V}$ ,  $T_{vj} = 175 \text{ °C}$

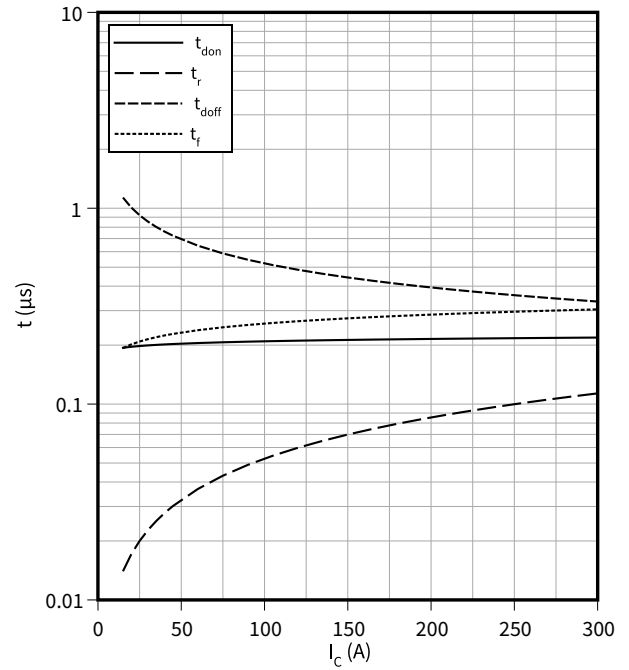

**Voltage slope (typical), IGBT, Inverter**

$dv/dt = f(R_G)$

$I_C = 150 \text{ A}$ ,  $V_{CE} = 25 \text{ V}$ ,  $V_{GE} = \pm 15 \text{ V}$ ,  $T_{vj} = 25 \text{ °C}$

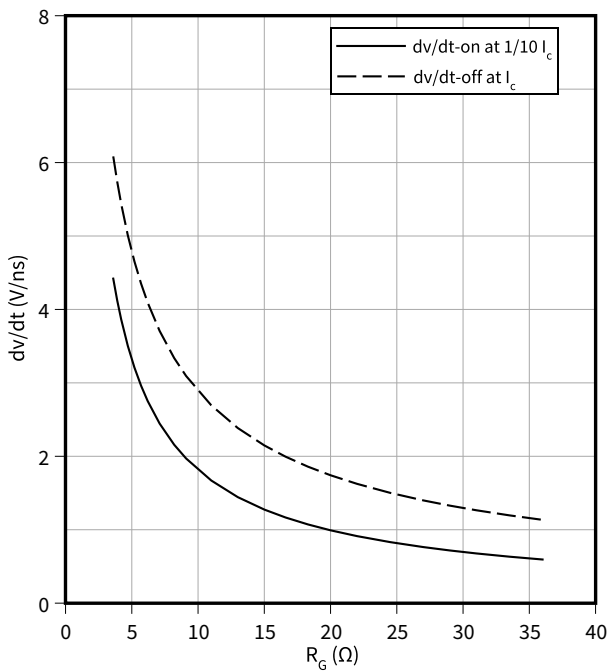

**Switching times (typical), IGBT, Inverter**

$t = f(R_G)$

$I_C = 150 \text{ A}$ ,  $V_{CE} = 600 \text{ V}$ ,  $V_{GE} = \pm 15 \text{ V}$ ,  $T_{vj} = 175 \text{ °C}$

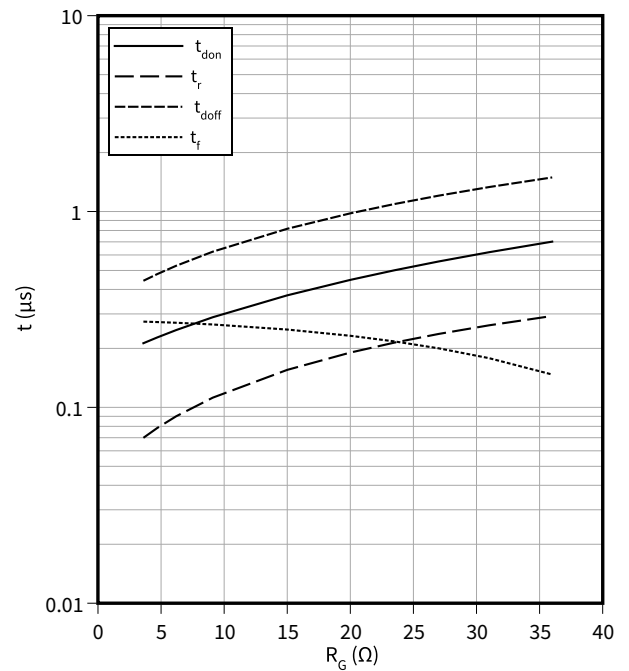



**Transient thermal impedance, IGBT, Inverter**

$Z_{th} = f(t)$

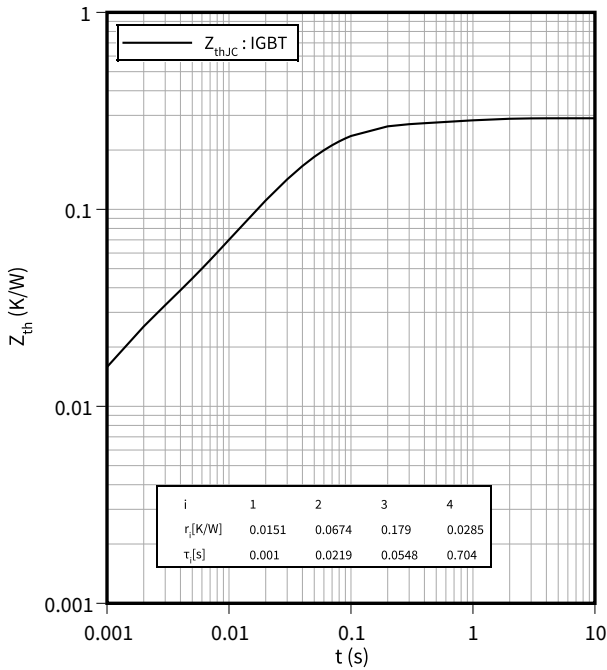

**Reverse bias safe operating area (RBSOA), IGBT, Inverter**

$I_C = f(V_{CE})$

$R_{Goff} = 3.6 \Omega, V_{GE} = \pm 15 V, T_{vj} = 175 \text{ }^\circ\text{C}$

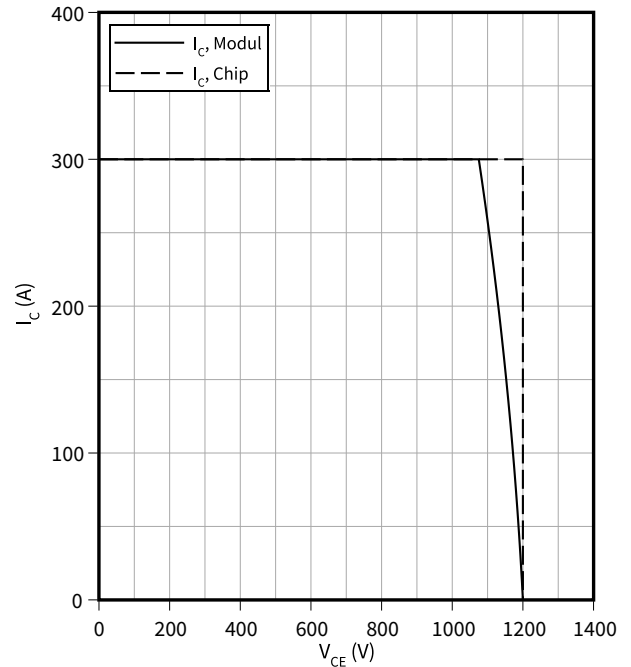

**Capacity characteristic (typical), IGBT, Inverter**

$C = f(V_{CE})$

$f = 100 \text{ kHz}, V_{GE} = 0 V, T_{vj} = 25 \text{ }^\circ\text{C}$

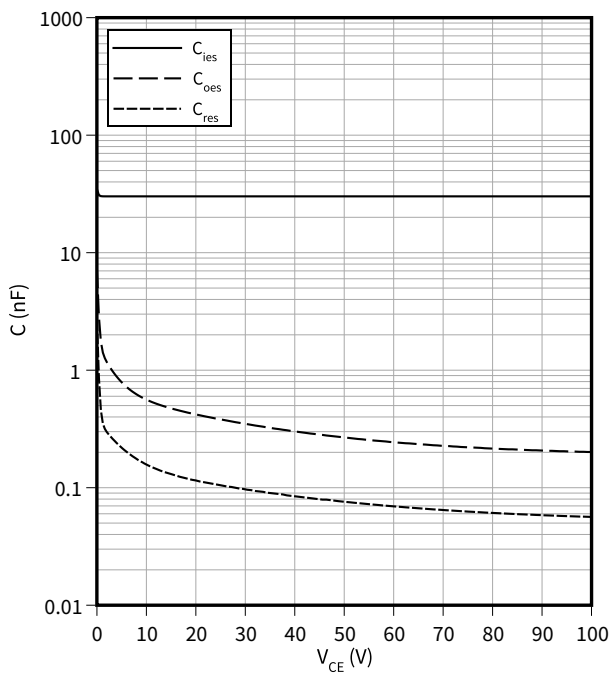

**Gate charge characteristic (typical), IGBT, Inverter**

$V_{GE} = f(Q_G)$

$I_C = 150 A, T_{vj} = 25 \text{ }^\circ\text{C}$

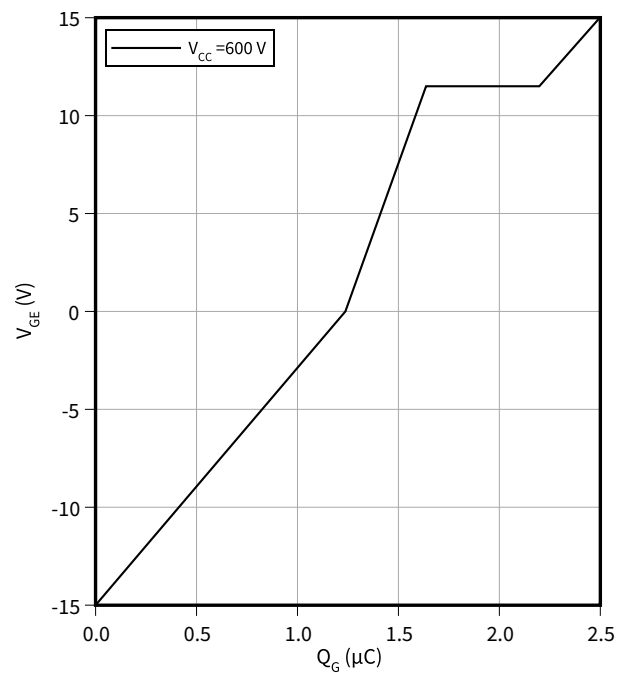

5 Characteristics diagrams

**Forward characteristic (typical), Diode, Inverter**

$I_F = f(V_F)$

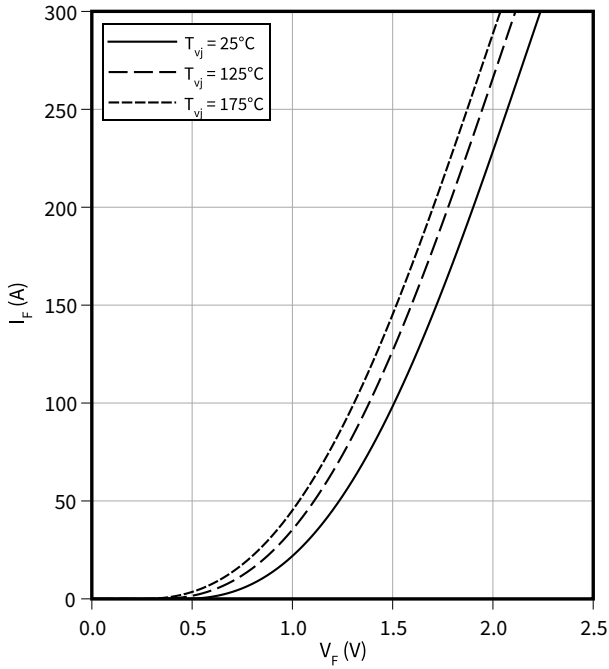

**Switching losses (typical), Diode, Inverter**

$E_{rec} = f(I_F)$

$R_{Gon} = 3.6 \Omega, V_R = 600 \text{ V}$

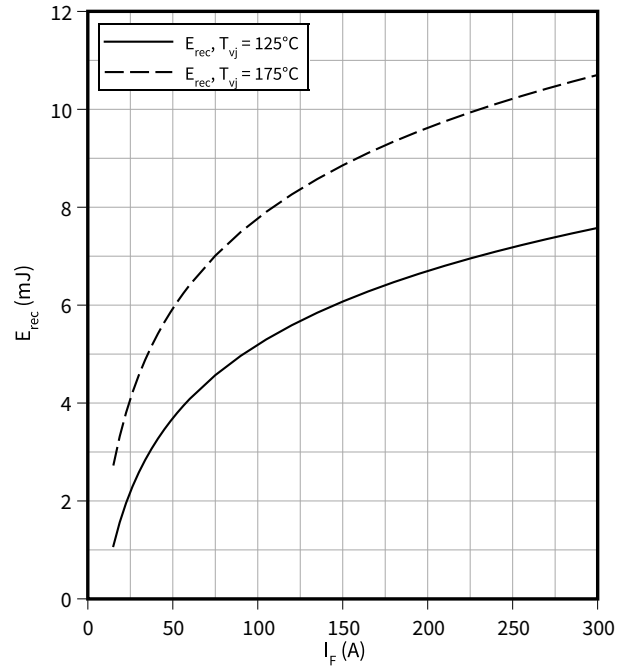

**Switching losses (typical), Diode, Inverter**

$E_{rec} = f(R_G)$

$I_F = 150 \text{ A}, V_R = 600 \text{ V}$

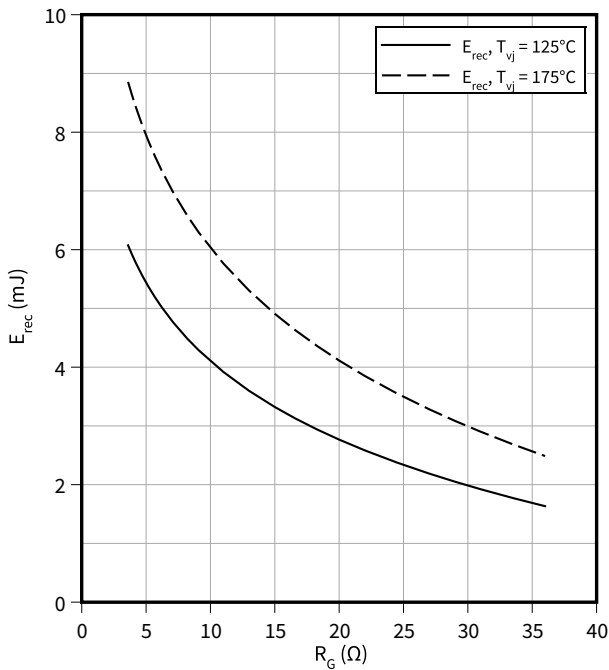

**Transient thermal impedance, Diode, Inverter**

$Z_{th} = f(t)$

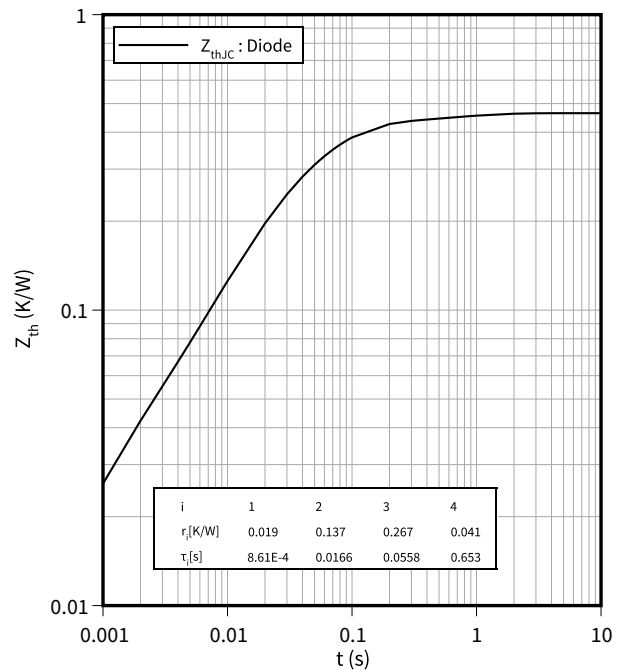

**Temperature characteristic (typical), NTC-Thermistor**

$R = f(T_{NTC})$

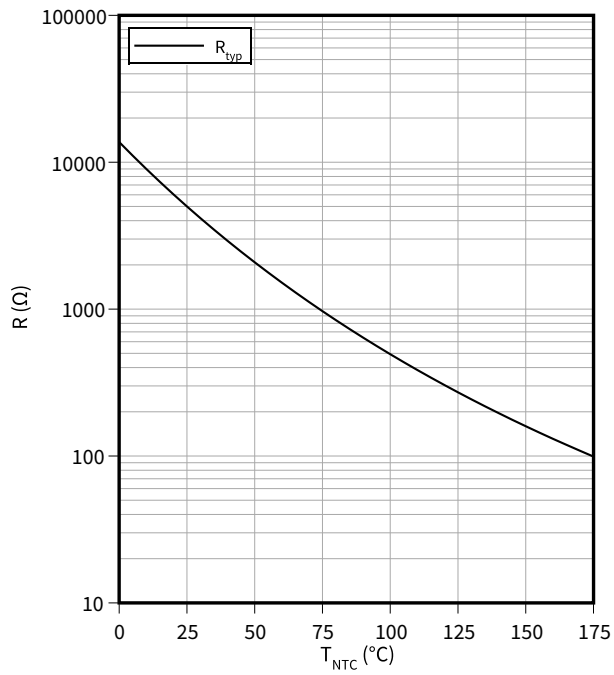

## 6 Circuit diagram

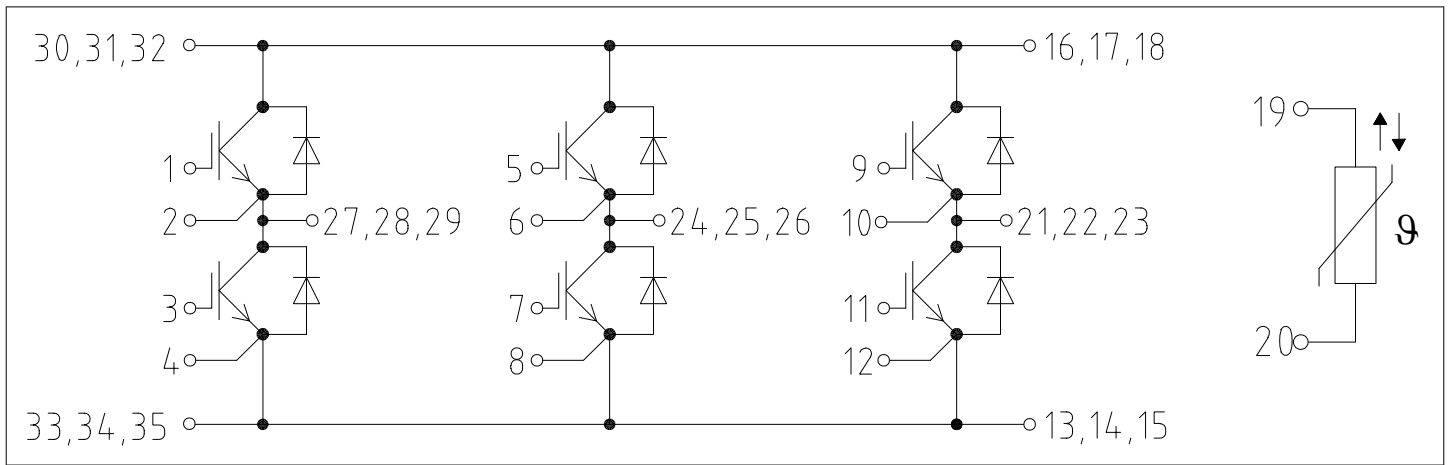

**Figure 1**

**7 Package outlines**

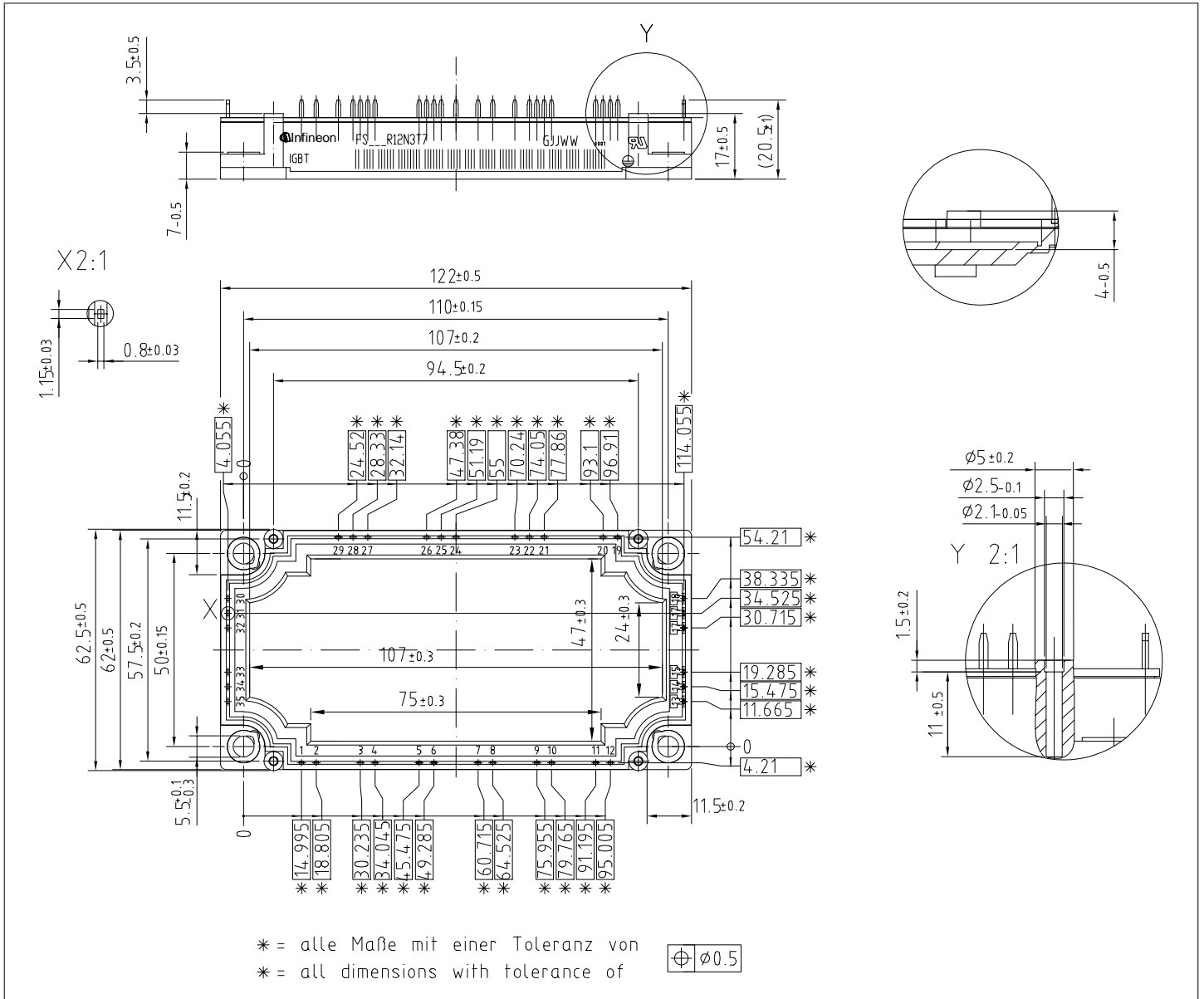

**Figure 2**

## 8 Module label code

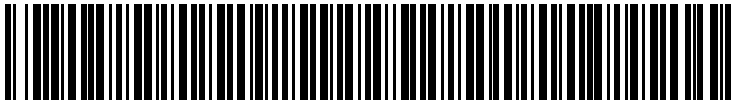
Module label code			
Code format	Data Matrix	Barcode Code128	
Encoding	ASCII text	Code Set A	
Symbol size	16x16	23 digits	
Standard	IEC24720 and IEC16022	IEC8859-1	
Code content	Content	Digit	Example
	Module serial number	1 - 5	71549
	Module material number	6 - 11	142846
	Production order number	12 - 19	55054991
	Date code (production year)	20 - 21	15
	Date code (production week)	22 - 23	30
Example			
	71549142846550549911530		71549142846550549911530

**Figure 3**

## Revision history

Document revision	Date of release	Description of changes
1.00	2022-01-31	Final datasheet

## Trademarks

All referenced product or service names and trademarks are the property of their respective owners.

**Edition 2022-01-31**

**Published by**

**Infineon Technologies AG**

**81726 Munich, Germany**

**© 2022 Infineon Technologies AG**

**All Rights Reserved.**

**Do you have a question about any aspect of this document?**

**Email: [erratum@infineon.com](mailto:erratum@infineon.com)**

**Document reference**

**IFX-AAY211-001**

## IMPORTANT NOTICE

The information given in this document shall in no event be regarded as a guarantee of conditions or characteristics ("Beschaffheitsgarantie").

With respect to any examples, hints or any typical values stated herein and/or any information regarding the application of the product, Infineon Technologies hereby disclaims any and all warranties and liabilities of any kind, including without limitation warranties of non-infringement of intellectual property rights of any third party.

In addition, any information given in this document is subject to customer's compliance with its obligations stated in this document and any applicable legal requirements, norms and standards concerning customer's products and any use of the product of Infineon Technologies in customer's applications.

The data contained in this document is exclusively intended for technically trained staff. It is the responsibility of customer's technical departments to evaluate the suitability of the product for the intended application and the completeness of the product information given in this document with respect to such application.

## WARNINGS

Due to technical requirements products may contain dangerous substances. For information on the types in question please contact your nearest Infineon Technologies office.

Except as otherwise explicitly approved by Infineon Technologies in a written document signed by authorized representatives of Infineon Technologies, Infineon Technologies' products may not be used in any applications where a failure of the product or any consequences of the use thereof can reasonably be expected to result in personal injury.