

## PrimePACK™3+ B-series module with TRENCHSTOP™ IGBT7 and emitter controlled 7 diode and NTC / pre-applied thermal interface material

### Features

- Electrical features
  - $V_{CES} = 2300\text{ V}$
  - $I_{C\text{nom}} = 1800\text{ A} / I_{CRM} = 3600\text{ A}$
  - TRENCHSTOP™ IGBT7
  - $T_{vj,op} = 150^{\circ}\text{C}$
  - Overload operation up to  $175^{\circ}\text{C}$
  - Low  $V_{CE,sat}$
  - Low switching losses
  - High current density
  - Low inductive design
- Mechanical features
  - Package with  $CTI > 400$
  - High creepage and clearance distances
  - High power density
  - Pre-applied thermal interface material



### Potential applications

- Three-level applications
- Solar applications

### Product validation

- Qualified for industrial applications according to the relevant tests of IEC 60747, 60749 and 60068

### Description

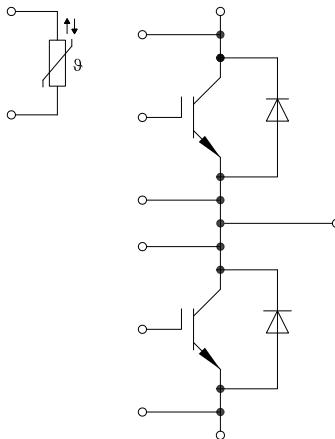

## Table of contents

	<b>Description</b> .....	1
	<b>Features</b> .....	1
	<b>Potential applications</b> .....	1
	<b>Product validation</b> .....	1
	<b>Table of contents</b> .....	2
<b>1</b>	<b>Package</b> .....	3
<b>2</b>	<b>IGBT, Inverter</b> .....	3
<b>3</b>	<b>Diode, Inverter</b> .....	5
<b>4</b>	<b>IGBT, 3-Level</b> .....	6
<b>5</b>	<b>Diode, 3-Level</b> .....	8
<b>6</b>	<b>NTC-Thermistor</b> .....	9
<b>7</b>	<b>Characteristics diagrams</b> .....	10
<b>8</b>	<b>Circuit diagram</b> .....	16
<b>9</b>	<b>Package outlines</b> .....	17
<b>10</b>	<b>Module label code</b> .....	18
	<b>Revision history</b> .....	19
	<b>Disclaimer</b> .....	20

## 1 Package

**Table 1** Insulation coordination

Parameter	Symbol	Note or test condition	Values	Unit
Isolation test voltage	$V_{ISOL}$	RMS, $f = 50$ Hz	4.0	kV
Material of module baseplate			Cu	
Creepage distance	$d_{Creep}$	terminal to heatsink	36.0	mm
Creepage distance	$d_{Creep}$	terminal to terminal	28.0	mm
Clearance	$d_{Clear}$	terminal to heatsink	21.0	mm
Clearance	$d_{Clear}$	terminal to terminal	19.0	mm
Comparative tracking index	$CTI$		> 400	

**Table 2** Characteristic values

Parameter	Symbol	Note or test condition	Values			Unit
			Min.	Typ.	Max.	
Stray inductance module	$L_{SCE}$			10		nH
Module lead resistance, terminals - chip	$R_{AA'+CC'}$	$T_H = 25$ °C, per switch		0.09		mΩ
Module lead resistance, terminals - chip	$R_{CC'+EE'}$	$T_H = 25$ °C, per switch		0.1		mΩ
Storage temperature	$T_{stg}$		-40		150	°C
Maximum baseplate operation temperature	$T_{BPmax}$				150	°C
Mounting torque for module mounting	$M$	- Mounting according to valid application note	M5, Screw	3	6	Nm
Terminal connection torque	$M$	- Mounting according to valid application note	M4, Screw	1.8	2.1	Nm
			M8, Screw	8	10	
Weight	$G$			1400		g

## 2 IGBT, Inverter

**Table 3** Maximum rated values

Parameter	Symbol	Note or test condition	Values	Unit
Collector-emitter voltage	$V_{CES}$	$T_{vj} = 25$ °C	2300	V
Implemented collector current	$I_{CN}$		1800	A
Continuous DC collector current	$I_{CDC}$	$T_{vj max} = 150$ °C $T_H = 45$ °C	1420	A

(table continues...)

**Table 3 (continued) Maximum rated values**

Parameter	Symbol	Note or test condition	Values	Unit
Repetitive peak collector current	$I_{CRM}$	$t_p$ limited by $T_{vj\ op}$	3600	A
Gate-emitter peak voltage	$V_{GES}$		±20	V

**Table 4 Characteristic values**

Parameter	Symbol	Note or test condition	Values			Unit
			Min.	Typ.	Max.	
Collector-emitter saturation voltage	$V_{CE\ sat}$	$I_C = 1800\ A, V_{GE} = 15\ V$	$T_{vj} = 25\ ^\circ C$	1.80	2.26	V
			$T_{vj} = 125\ ^\circ C$	2.15	2.94	
			$T_{vj} = 150\ ^\circ C$	2.25	3.13	
Gate threshold voltage	$V_{GEth}$	$I_C = 49.5\ mA, V_{CE} = V_{GE}, T_{vj} = 25\ ^\circ C$	5.15	5.80	6.45	V
Gate charge	$Q_G$	$V_{GE} = \pm 15\ V, V_{CC} = 1200\ V$		14.6		μC
Internal gate resistor	$R_{Gint}$	$T_{vj} = 25\ ^\circ C$		0.96		Ω
Input capacitance	$C_{ies}$	$f = 100\ kHz, T_{vj} = 25\ ^\circ C, V_{CE} = 25\ V, V_{GE} = 0\ V$		225		nF
Reverse transfer capacitance	$C_{res}$	$f = 100\ kHz, T_{vj} = 25\ ^\circ C, V_{CE} = 25\ V, V_{GE} = 0\ V$		0.54		nF
Collector-emitter cut-off current	$I_{CES}$	$V_{CE} = 2300\ V, V_{GE} = 0\ V$			30	mA
Gate-emitter leakage current	$I_{GES}$	$V_{CE} = 0\ V, V_{GE} = 20\ V, T_{vj} = 25\ ^\circ C$			400	nA
Turn-on delay time (inductive load)	$t_{don}$	$I_C = 1800\ A, V_{CC} = 1200\ V, V_{GE} = \pm 15\ V, R_{Gon} = 0.1\ \Omega$	$T_{vj} = 25\ ^\circ C$	0.530		μs
			$T_{vj} = 125\ ^\circ C$	0.550		
			$T_{vj} = 150\ ^\circ C$	0.560		
Rise time (inductive load)	$t_r$	$I_C = 1800\ A, V_{CC} = 1200\ V, V_{GE} = \pm 15\ V, R_{Gon} = 0.1\ \Omega$	$T_{vj} = 25\ ^\circ C$	0.072		μs
			$T_{vj} = 125\ ^\circ C$	0.078		
			$T_{vj} = 150\ ^\circ C$	0.083		
Turn-off delay time (inductive load)	$t_{doff}$	$I_C = 1800\ A, V_{CC} = 1200\ V, V_{GE} = \pm 15\ V, R_{Goff} = 1.5\ \Omega$	$T_{vj} = 25\ ^\circ C$	0.955		μs
			$T_{vj} = 125\ ^\circ C$	1.050		
			$T_{vj} = 150\ ^\circ C$	1.080		
Fall time (inductive load)	$t_f$	$I_C = 1800\ A, V_{CC} = 1200\ V, V_{GE} = \pm 15\ V, R_{Goff} = 1.5\ \Omega$	$T_{vj} = 25\ ^\circ C$	0.770		μs
			$T_{vj} = 125\ ^\circ C$	1.020		
			$T_{vj} = 150\ ^\circ C$	1.100		
Turn-on time (resistive load)	$t_{on\_R}$	$I_C = 500\ A, V_{CC} = 2000\ V, V_{GE} = \pm 15\ V, R_{Gon} = 0.1\ \Omega$	0.79			μs

**(table continues...)**

**Table 4 (continued) Characteristic values**

Parameter	Symbol	Note or test condition	Values			Unit
			Min.	Typ.	Max.	
Turn-on energy loss per pulse	$E_{on}$	$I_C = 1800\text{ A}, V_{CC} = 1200\text{ V}, L_\sigma = 20\text{ nH}, V_{GE} = \pm 15\text{ V}, R_{Gon} = 0.1\ \Omega, di/dt = 17500\text{ A}/\mu\text{s} (T_{vj} = 150\text{ }^\circ\text{C})$	$T_{vj} = 25\text{ }^\circ\text{C}$	570		mJ
			$T_{vj} = 125\text{ }^\circ\text{C}$	815		
			$T_{vj} = 150\text{ }^\circ\text{C}$	915		
Turn-off energy loss per pulse	$E_{off}$	$I_C = 1800\text{ A}, V_{CC} = 1200\text{ V}, L_\sigma = 20\text{ nH}, V_{GE} = \pm 15\text{ V}, R_{Goff} = 1.5\ \Omega, dv/dt = 4050\text{ V}/\mu\text{s} (T_{vj} = 150\text{ }^\circ\text{C})$	$T_{vj} = 25\text{ }^\circ\text{C}$	885		mJ
			$T_{vj} = 125\text{ }^\circ\text{C}$	1160		
			$T_{vj} = 150\text{ }^\circ\text{C}$	1240		
SC data	$I_{SC}$	$V_{GE} \leq 15\text{ V}, V_{CC} = 1200\text{ V}, V_{CEmax} = V_{CES} - L_{sCE} * di/dt$	$t_p \leq 7\ \mu\text{s}, T_{vj} = 150\text{ }^\circ\text{C}$	8000		A
Thermal resistance, junction to heat sink	$R_{thJH}$	per IGBT, Valid with IFX pre-applied Thermal Interface Material				27.4 K/kW
Temperature under switching conditions	$T_{vj\ op}$			-40		150 °C

Note:  $R_{thJH}$  max. value is valid for  $T_C = 105\text{ }^\circ\text{C}$ .

### 3 Diode, Inverter

**Table 5 Maximum rated values**

Parameter	Symbol	Note or test condition	Values	Unit	
Repetitive peak reverse voltage	$V_{RRM}$	$T_{vj} = 25\text{ }^\circ\text{C}$	2300	V	
Continuous DC forward current	$I_F$		1800	A	
Repetitive peak forward current	$I_{FRM}$	$t_p = 1\text{ ms}$	3600	A	
$I^2t$ - value	$I^2t$	$t_p = 10\text{ ms}, V_R = 0\text{ V}$	$T_{vj} = 125\text{ }^\circ\text{C}$	220	kA <sup>2</sup> s
			$T_{vj} = 150\text{ }^\circ\text{C}$	205	
Maximum power dissipation	$P_{RQM}$	$T_{vj} = 150\text{ }^\circ\text{C}$	2700	kW	

**Table 6 Characteristic values**

Parameter	Symbol	Note or test condition	Values			Unit	
			Min.	Typ.	Max.		
Forward voltage	$V_F$	$I_F = 1800\text{ A}, V_{GE} = 0\text{ V}$	$T_{vj} = 25\text{ }^\circ\text{C}$		3.25	3.64	V
			$T_{vj} = 125\text{ }^\circ\text{C}$		3.00	3.33	
			$T_{vj} = 150\text{ }^\circ\text{C}$		2.95	3.22	

(table continues...)

**Table 6 (continued) Characteristic values**

Parameter	Symbol	Note or test condition	Values			Unit
			Min.	Typ.	Max.	
Peak reverse recovery current	$I_{RM}$	$V_{CC} = 1200\text{ V}$ , $I_F = 1800\text{ A}$ , $V_{GE} = -15\text{ V}$ , $-di_F/dt = 17500\text{ A}/\mu\text{s}$ ( $T_{vj} = 150\text{ °C}$ )	$T_{vj} = 25\text{ °C}$	1700		A
			$T_{vj} = 125\text{ °C}$	1870		
			$T_{vj} = 150\text{ °C}$	1880		
Recovered charge	$Q_r$	$V_{CC} = 1200\text{ V}$ , $I_F = 1800\text{ A}$ , $V_{GE} = -15\text{ V}$ , $-di_F/dt = 17500\text{ A}/\mu\text{s}$ ( $T_{vj} = 150\text{ °C}$ )	$T_{vj} = 25\text{ °C}$	300		$\mu\text{C}$
			$T_{vj} = 125\text{ °C}$	625		
			$T_{vj} = 150\text{ °C}$	740		
Reverse recovery energy	$E_{rec}$	$V_{CC} = 1200\text{ V}$ , $I_F = 1800\text{ A}$ , $V_{GE} = -15\text{ V}$ , $-di_F/dt = 17500\text{ A}/\mu\text{s}$ ( $T_{vj} = 150\text{ °C}$ )	$T_{vj} = 25\text{ °C}$	240		mJ
			$T_{vj} = 125\text{ °C}$	500		
			$T_{vj} = 150\text{ °C}$	590		
Thermal resistance, junction to heat sink	$R_{thJH}$	per diode, Valid with IFX pre-applied Thermal Interface Material			53.6	K/kW
Temperature under switching conditions	$T_{vj\text{ op}}$		-40		150	$^{\circ}\text{C}$

Note:  $R_{thJH}$  max. value is valid for  $T_C = 90\text{ °C}$ .

## 4 IGBT, 3-Level

**Table 7 Maximum rated values**

Parameter	Symbol	Note or test condition	Values	Unit
Collector-emitter voltage	$V_{CES}$	$T_{vj} = 25\text{ °C}$	2300	V
Implemented collector current	$I_{CN}$		1800	A
Continuous DC collector current	$I_{CDC}$	$T_{vj\text{ max}} = 150\text{ °C}$ $T_H = 45\text{ °C}$	1420	A
Repetitive peak collector current	$I_{CRM}$	$t_p$ limited by $T_{vj\text{ op}}$	3600	A
Gate-emitter peak voltage	$V_{GES}$		$\pm 20$	V

**Table 8 Characteristic values**

Parameter	Symbol	Note or test condition	Values			Unit
			Min.	Typ.	Max.	
Collector-emitter saturation voltage	$V_{CE\text{ sat}}$	$I_C = 1800\text{ A}$ , $V_{GE} = 15\text{ V}$	$T_{vj} = 25\text{ °C}$	1.80	2.26	V
			$T_{vj} = 125\text{ °C}$	2.15	2.94	
			$T_{vj} = 150\text{ °C}$	2.25	3.13	
Gate threshold voltage	$V_{GEth}$	$I_C = 49.5\text{ mA}$ , $V_{CE} = V_{GE}$ , $T_{vj} = 25\text{ °C}$	5.15	5.80	6.45	V

(table continues...)

**Table 8 (continued) Characteristic values**

Parameter	Symbol	Note or test condition	Values			Unit
			Min.	Typ.	Max.	
Gate charge	$Q_G$	$V_{GE} = \pm 15\text{ V}, V_{CC} = 1200\text{ V}$		14.6		$\mu\text{C}$
Internal gate resistor	$R_{Gint}$	$T_{vj} = 25\text{ }^\circ\text{C}$		0.96		$\Omega$
Input capacitance	$C_{ies}$	$f = 100\text{ kHz}, T_{vj} = 25\text{ }^\circ\text{C}, V_{CE} = 25\text{ V}, V_{GE} = 0\text{ V}$		225		nF
Reverse transfer capacitance	$C_{res}$	$f = 100\text{ kHz}, T_{vj} = 25\text{ }^\circ\text{C}, V_{CE} = 25\text{ V}, V_{GE} = 0\text{ V}$		0.54		nF
Collector-emitter cut-off current	$I_{CES}$	$V_{CE} = 2300\text{ V}, V_{GE} = 0\text{ V}$ $T_{vj} = 125\text{ }^\circ\text{C}$			30	mA
Gate-emitter leakage current	$I_{GES}$	$V_{CE} = 0\text{ V}, V_{GE} = 20\text{ V}, T_{vj} = 25\text{ }^\circ\text{C}$			400	nA
Turn-on delay time (inductive load)	$t_{don}$	$I_C = 1800\text{ A}, V_{CC} = 600\text{ V}, V_{GE} = \pm 15\text{ V}$	$T_{vj} = 25\text{ }^\circ\text{C}$	0.555		$\mu\text{s}$
			$T_{vj} = 125\text{ }^\circ\text{C}$	0.580		
			$T_{vj} = 150\text{ }^\circ\text{C}$	0.590		
Rise time (inductive load)	$t_r$	$I_C = 1800\text{ A}, V_{CC} = 600\text{ V}, V_{GE} = \pm 15\text{ V}$	$T_{vj} = 25\text{ }^\circ\text{C}$	0.190		$\mu\text{s}$
			$T_{vj} = 125\text{ }^\circ\text{C}$	0.205		
			$T_{vj} = 150\text{ }^\circ\text{C}$	0.215		
Turn-off delay time (inductive load)	$t_{doff}$	$I_C = 1800\text{ A}, V_{CC} = 600\text{ V}, V_{GE} = \pm 15\text{ V}, R_{Goff} = 1.5\text{ }\Omega$	$T_{vj} = 25\text{ }^\circ\text{C}$	0.885		$\mu\text{s}$
			$T_{vj} = 125\text{ }^\circ\text{C}$	0.955		
			$T_{vj} = 150\text{ }^\circ\text{C}$	0.980		
Fall time (inductive load)	$t_f$	$I_C = 1800\text{ A}, V_{CC} = 600\text{ V}, V_{GE} = \pm 15\text{ V}, R_{Goff} = 1.5\text{ }\Omega$	$T_{vj} = 25\text{ }^\circ\text{C}$	0.630		$\mu\text{s}$
			$T_{vj} = 125\text{ }^\circ\text{C}$	0.875		
			$T_{vj} = 150\text{ }^\circ\text{C}$	0.930		
Turn-on energy loss per pulse	$E_{on}$	$I_C = 1800\text{ A}, V_{CC} = 600\text{ V}, L_\sigma = 50\text{ nH}, V_{GE} = \pm 15\text{ V}, R_{Gon} = 0.1\text{ }\Omega, di/dt = 6700\text{ A}/\mu\text{s} (T_{vj} = 150\text{ }^\circ\text{C})$	$T_{vj} = 25\text{ }^\circ\text{C}$	240		mJ
			$T_{vj} = 125\text{ }^\circ\text{C}$	380		
			$T_{vj} = 150\text{ }^\circ\text{C}$	430		
Turn-off energy loss per pulse	$E_{off}$	$I_C = 1800\text{ A}, V_{CC} = 600\text{ V}, L_\sigma = 50\text{ nH}, V_{GE} = \pm 15\text{ V}, R_{Goff} = 1.5\text{ }\Omega, dv/dt = 3150\text{ V}/\mu\text{s} (T_{vj} = 150\text{ }^\circ\text{C})$	$T_{vj} = 25\text{ }^\circ\text{C}$	490		mJ
			$T_{vj} = 125\text{ }^\circ\text{C}$	630		
			$T_{vj} = 150\text{ }^\circ\text{C}$	665		
Thermal resistance, junction to heat sink	$R_{thJH}$	per IGBT, Valid with IFX pre-applied Thermal Interface Material			27.4	K/kW
Temperature under switching conditions	$T_{vj\text{ op}}$		-40		150	$^\circ\text{C}$

Note:  $R_{thJH}$  max. value is valid for  $T_C = 105\text{ }^\circ\text{C}$ .

## 5 Diode, 3-Level

**Table 9** Maximum rated values

Parameter	Symbol	Note or test condition	Values	Unit
Repetitive peak reverse voltage	$V_{RRM}$	$T_{vj} = 25\text{ °C}$	2300	V
Continuous DC forward current	$I_F$		1800	A
Repetitive peak forward current	$I_{FRM}$	$t_p = 1\text{ ms}$	3600	A

**Table 10** Characteristic values

Parameter	Symbol	Note or test condition	Values			Unit
			Min.	Typ.	Max.	
Forward voltage	$V_F$	$I_F = 1800\text{ A}, V_{GE} = 0\text{ V}$	$T_{vj} = 25\text{ °C}$	3.25	3.64	V
			$T_{vj} = 125\text{ °C}$	3.00	3.33	
			$T_{vj} = 150\text{ °C}$	2.95	3.22	
Peak reverse recovery current	$I_{RM}$	$V_{CC} = 600\text{ V}, I_F = 1800\text{ A}, V_{GE} = -15\text{ V}, -di_F/dt = 8200\text{ A}/\mu\text{s} (T_{vj} = 150\text{ °C})$	$T_{vj} = 25\text{ °C}$	1120		A
			$T_{vj} = 125\text{ °C}$	1450		
			$T_{vj} = 150\text{ °C}$	1530		
Recovered charge	$Q_r$	$V_{CC} = 600\text{ V}, I_F = 1800\text{ A}, V_{GE} = -15\text{ V}, -di_F/dt = 8200\text{ A}/\mu\text{s} (T_{vj} = 150\text{ °C})$	$T_{vj} = 25\text{ °C}$	295		$\mu\text{C}$
			$T_{vj} = 125\text{ °C}$	580		
			$T_{vj} = 150\text{ °C}$	665		
Reverse recovery energy	$E_{rec}$	$V_{CC} = 600\text{ V}, I_F = 1800\text{ A}, V_{GE} = -15\text{ V}, -di_F/dt = 8200\text{ A}/\mu\text{s} (T_{vj} = 150\text{ °C})$	$T_{vj} = 25\text{ °C}$	170		mJ
			$T_{vj} = 125\text{ °C}$	320		
			$T_{vj} = 150\text{ °C}$	365		
Thermal resistance, junction to heat sink	$R_{thJH}$	per diode, Valid with IFX pre-applied Thermal Interface Material			53.6	K/kW
Temperature under switching conditions	$T_{vj\text{ op}}$		-40		150	$^{\circ}\text{C}$

**Note:** Dynamic data for 3-level valid in conjunction with FF2400RB12IP7.  
 $T_{vj\text{ op}}$  up to 175 °C is allowed for operations in overload conditions. For detailed specifications please refer to AN2021-11.  
 $R_{thJH}$  max. value is valid for  $T_C = 90\text{ °C}$ .  
For use in brake chopper applications and other conditions requiring blocking operation for extended time, contact your sales partner for Infineon products.



## 6 NTC-Thermistor

**Table 11** Characteristic values

Parameter	Symbol	Note or test condition	Values			Unit
			Min.	Typ.	Max.	
Rated resistance	$R_{25}$	$T_{NTC} = 25\text{ °C}$		5		kΩ
Deviation of $R_{100}$	$\Delta R/R$	$T_{NTC} = 100\text{ °C}, R_{100} = 493\text{ }\Omega$	-5		5	%
Power dissipation	$P_{25}$	$T_{NTC} = 25\text{ °C}$			20	mW
B-value	$B_{25/50}$	$R_2 = R_{25} \exp[B_{25/50}(1/T_2 - 1/(298,15\text{ K}))]$		3375		K
B-value	$B_{25/80}$	$R_2 = R_{25} \exp[B_{25/80}(1/T_2 - 1/(298,15\text{ K}))]$		3411		K
B-value	$B_{25/100}$	$R_2 = R_{25} \exp[B_{25/100}(1/T_2 - 1/(298,15\text{ K}))]$		3433		K

Note: For an analytical description of the NTC characteristics please refer to AN2009-10, chapter 4.

## 7 Characteristics diagrams

**Output characteristic (typical), IGBT, Inverter**

$$I_C = f(V_{CE})$$

$$V_{GE} = 15 \text{ V}$$

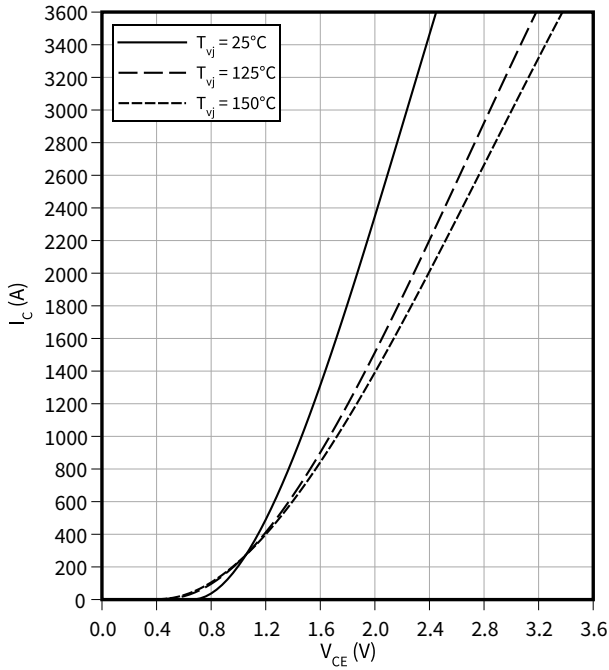

**Output characteristic field (typical), IGBT, Inverter**

$$I_C = f(V_{CE})$$

$$T_{vj} = 150 \text{ °C}$$

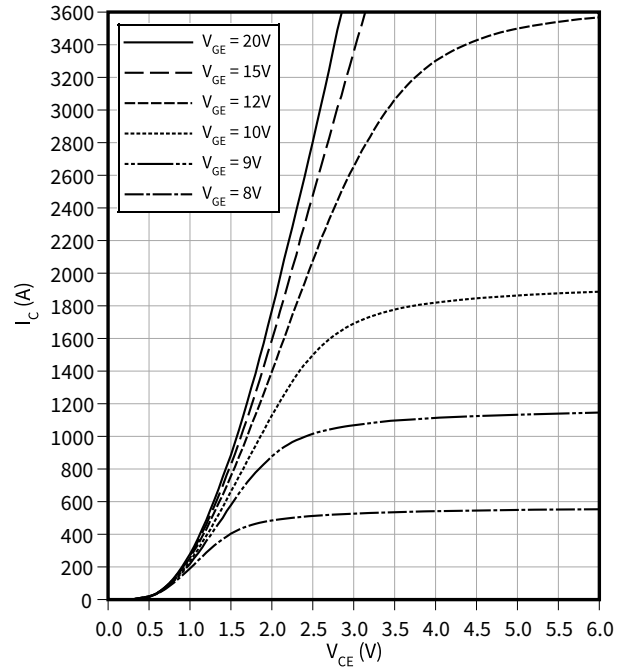

**Transfer characteristic (typical), IGBT, Inverter**

$$I_C = f(V_{GE})$$

$$V_{CE} = 20 \text{ V}$$

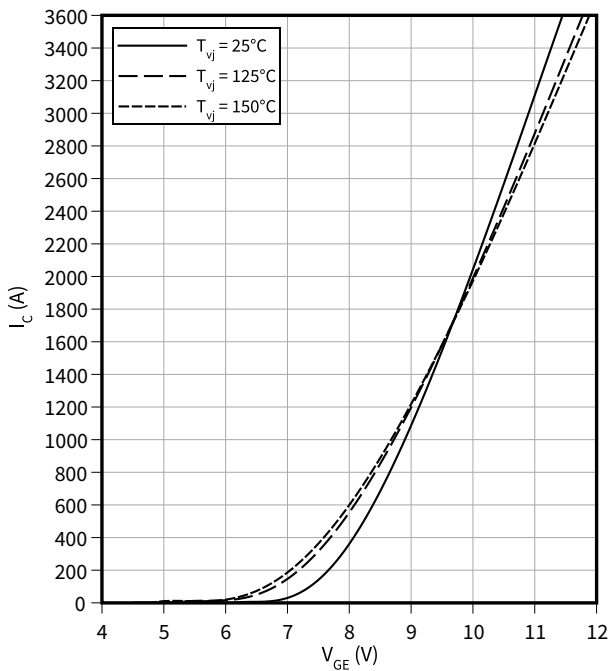

**Gate charge characteristic (typical), IGBT, Inverter**

$$V_{GE} = f(Q_G)$$

$$I_C = 1800 \text{ A}, T_{vj} = 25 \text{ °C}$$

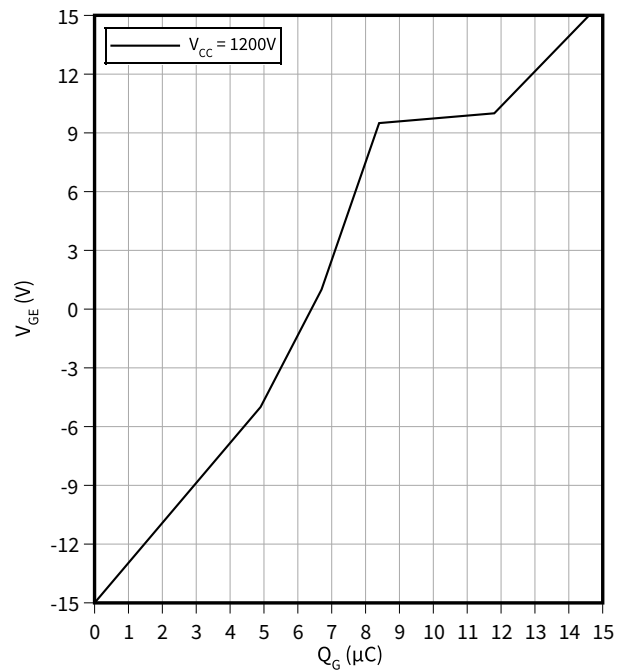

**Capacity characteristic (typical), IGBT, Inverter**

$C = f(V_{CE})$   
 $f = 100 \text{ kHz}, V_{GE} = 0 \text{ V}, T_{vj} = 25 \text{ }^\circ\text{C}$

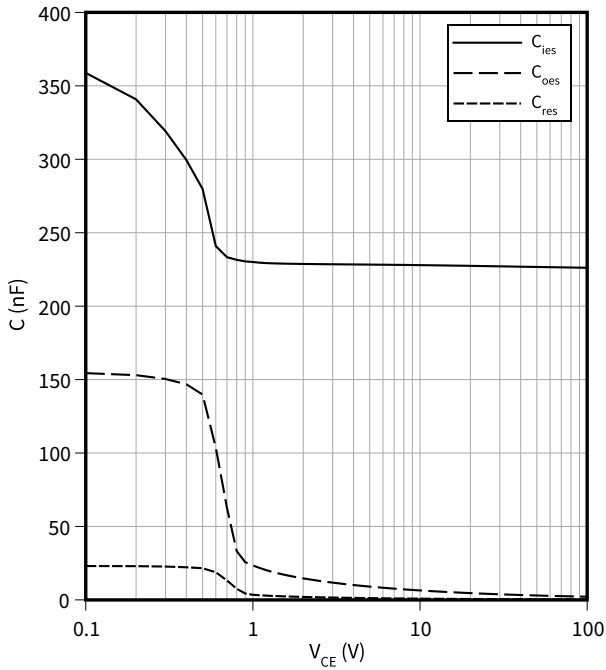

**Switching times (typical), IGBT, Inverter**

$t = f(I_C)$   
 $R_{Goff} = 1.5 \text{ } \Omega, R_{Gon} = 0.1 \text{ } \Omega, V_{CC} = 1200 \text{ V}, V_{GE} = \pm 15 \text{ V}, T_{vj} = 150 \text{ }^\circ\text{C}$

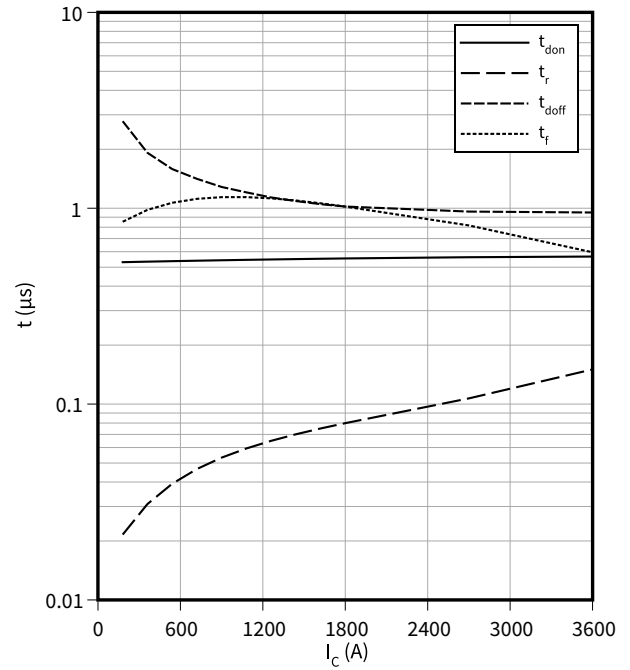

**Switching times (typical), IGBT, Inverter**

$t = f(R_G)$   
 $V_{GE} = \pm 15 \text{ V}, I_C = 1800 \text{ A}, T_{vj} = 150 \text{ }^\circ\text{C}, V_{CC} = 1200 \text{ V}$

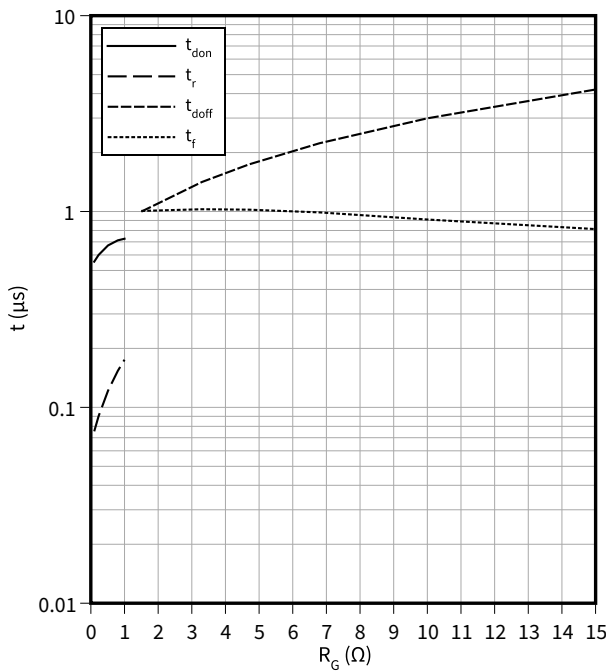

**Switching losses (typical), IGBT, Inverter**

$E = f(I_C)$   
 $R_{Goff} = 1.5 \text{ } \Omega, R_{Gon} = 0.1 \text{ } \Omega, V_{CC} = 1200 \text{ V}, V_{GE} = \pm 15 \text{ V}$

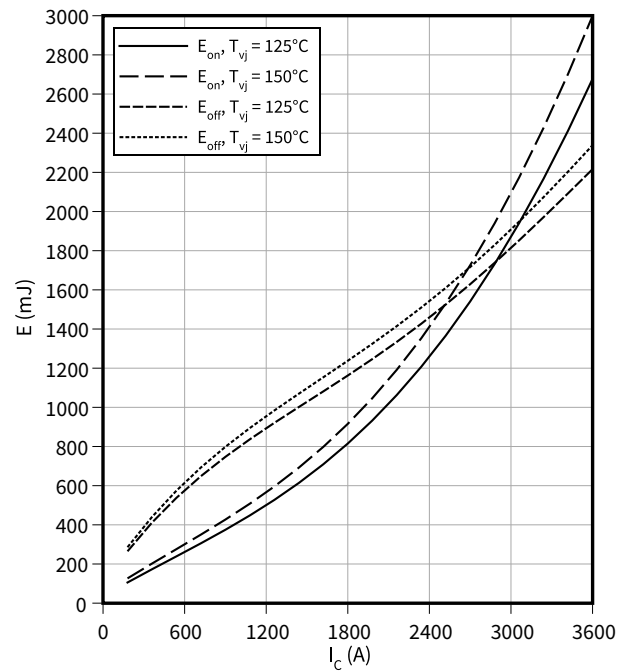

7 Characteristics diagrams

**Switching losses (typical), IGBT, Inverter**

$E = f(R_G)$

$I_C = 1800 \text{ A}$ ,  $V_{CC} = 1200 \text{ V}$ ,  $V_{GE} = \pm 15 \text{ V}$

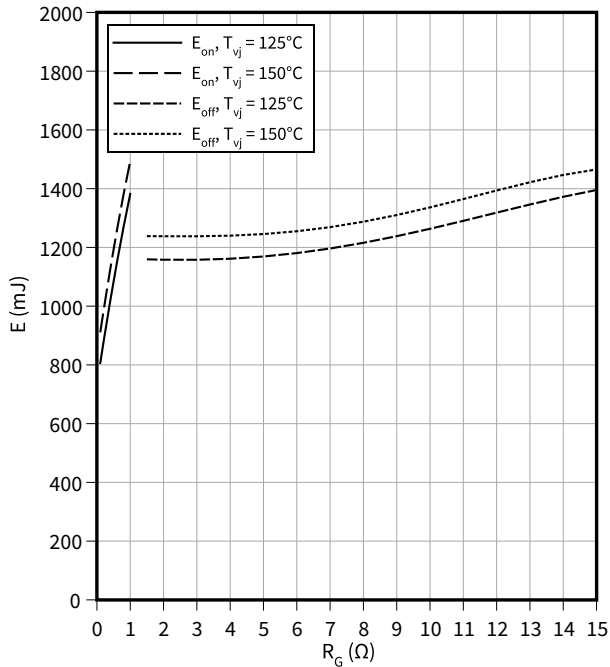

**Reverse bias safe operating area (RBSOA), IGBT, Inverter**

$I_C = f(V_{CE})$

$R_{Goff} = 1.5 \Omega$ ,  $V_{GE} = \pm 15 \text{ V}$ ,  $T_{vj} = 150 \text{ °C}$

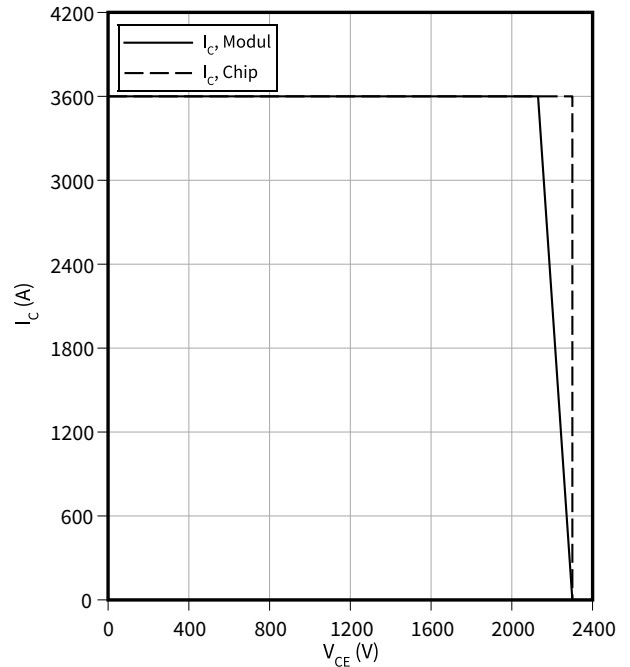

**Transient thermal impedance, IGBT, Inverter**

$Z_{th} = f(t)$

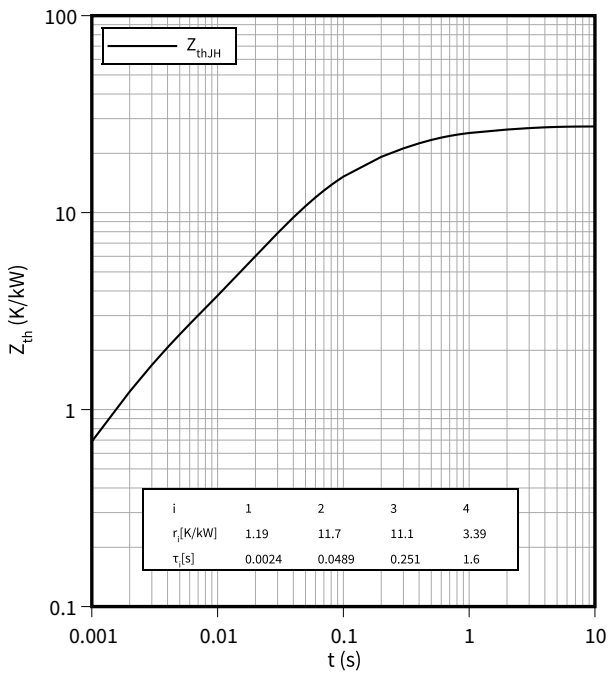

**Forward characteristic (typical), Diode, Inverter**

$I_F = f(V_F)$

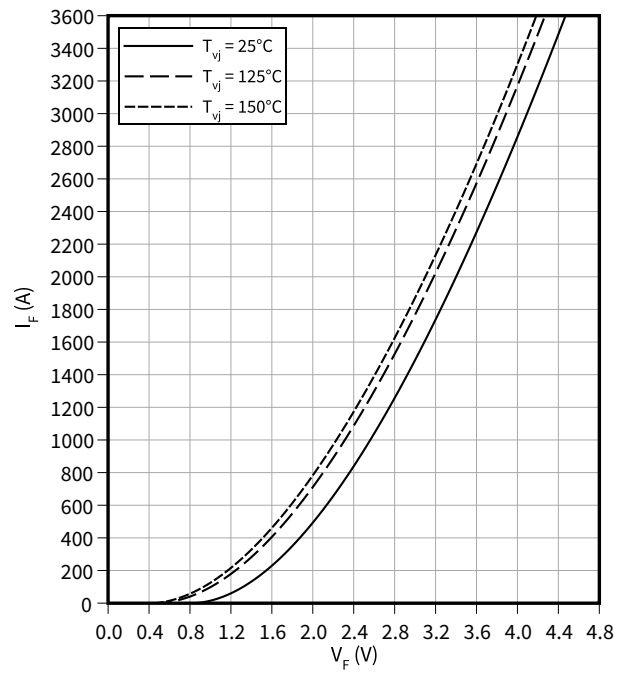

7 Characteristics diagrams

**Switching losses (typical), Diode, Inverter**

$E_{rec} = f(I_F)$   
 $V_{CE} = 1200\text{ V}, R_{Gon} = R_{Gon}(IGBT)$

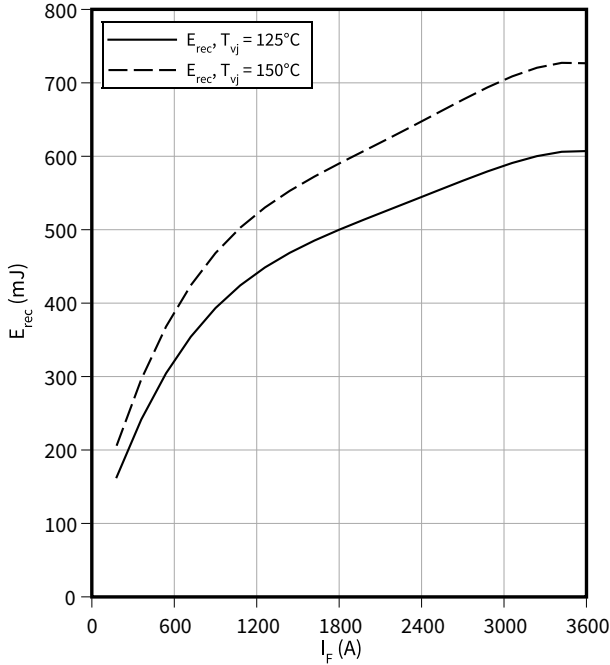

**Switching losses (typical), Diode, Inverter**

$E_{rec} = f(R_G)$   
 $I_F = 1800\text{ A}, V_{CE} = 1200\text{ V}$

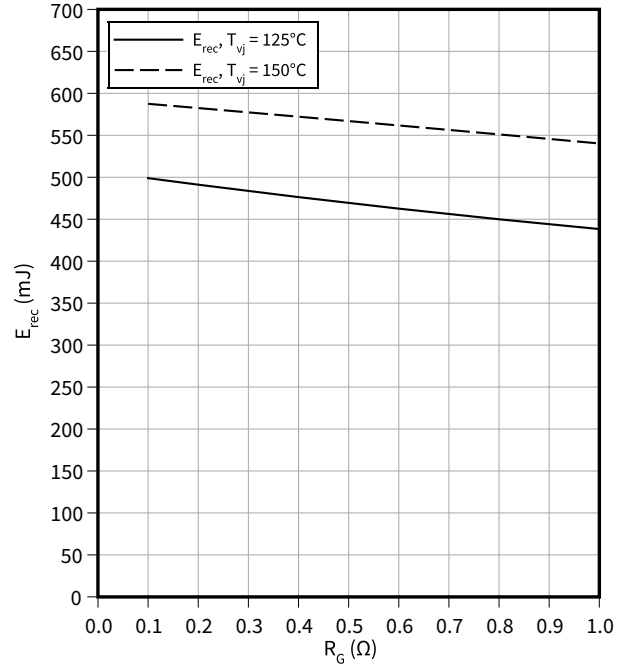

**Safe operating area (SOA), Diode, Inverter**

$I_R = f(V_R)$   
 $T_{vj} = 150\text{ °C}$

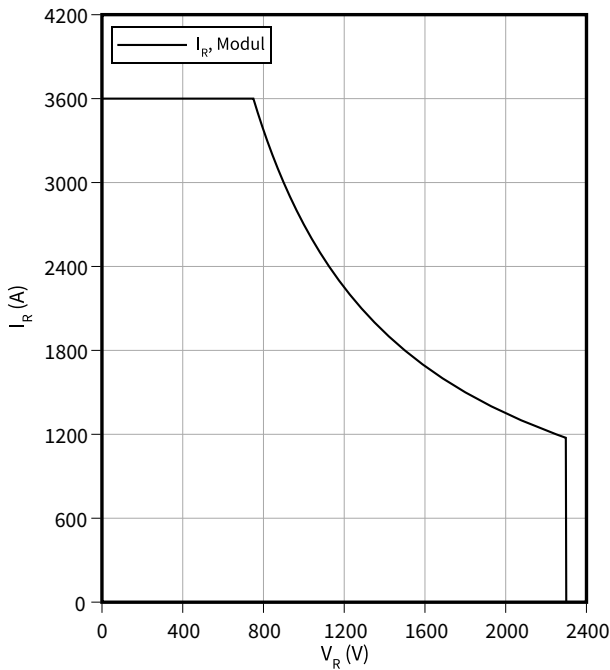

**Transient thermal impedance, Diode, Inverter**

$Z_{th} = f(t)$

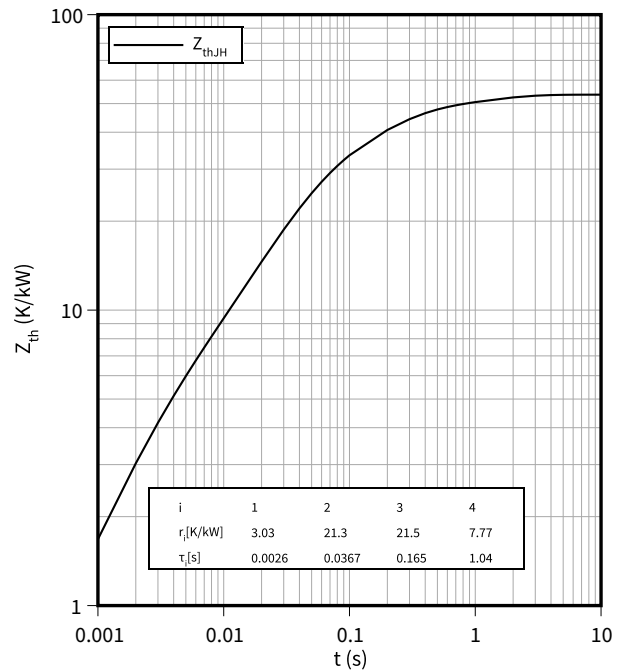

7 Characteristics diagrams

**Switching times (typical), IGBT, 3-Level**

$t = f(I_C)$

$R_{Goff} = 1.5 \Omega$ ,  $R_{Gon} = 0.1 \Omega$ ,  $V_{CC} = 600 \text{ V}$ ,  $V_{GE} = \pm 15 \text{ V}$ ,  $T_{vj} = 150 \text{ }^\circ\text{C}$

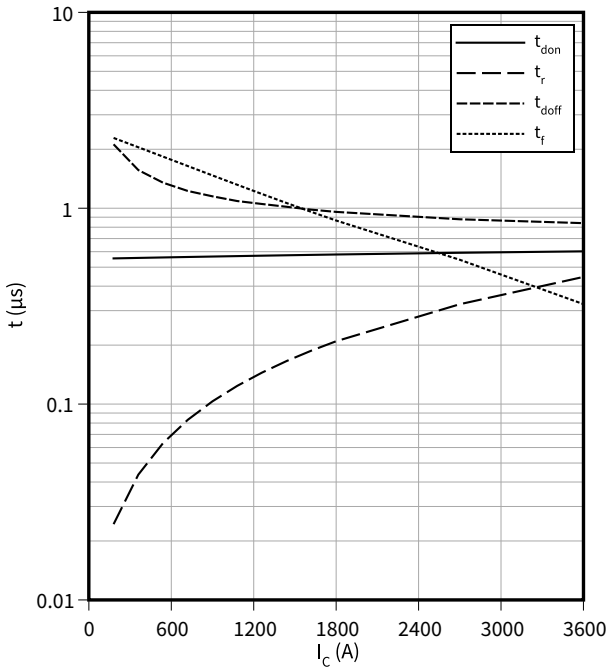

**Switching times (typical), IGBT, 3-Level**

$t = f(R_G)$

$I_C = 1800 \text{ A}$ ,  $V_{CC} = 600 \text{ V}$ ,  $V_{GE} = \pm 15 \text{ V}$ ,  $T_{vj} = 150 \text{ }^\circ\text{C}$

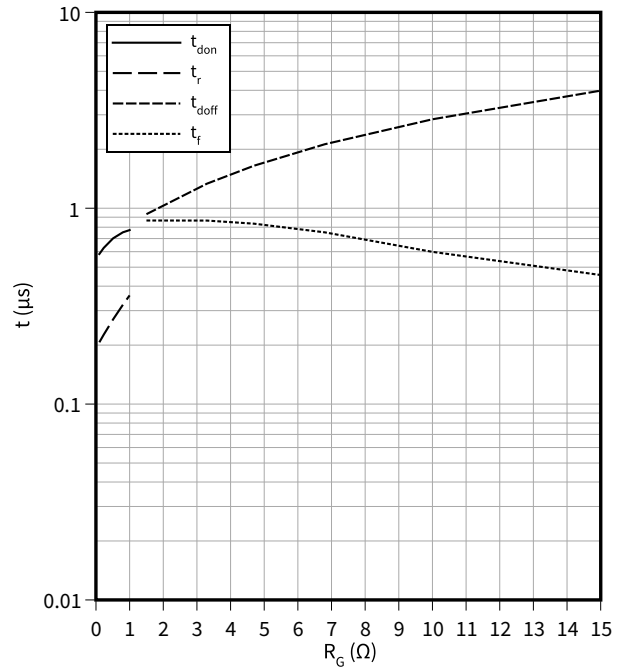

**Switching losses (typical), IGBT, 3-Level**

$E = f(I_C)$

$R_{Goff} = 1.5 \Omega$ ,  $R_{Gon} = 0.1 \Omega$ ,  $V_{CC} = 600 \text{ V}$ ,  $V_{GE} = \pm 15 \text{ V}$

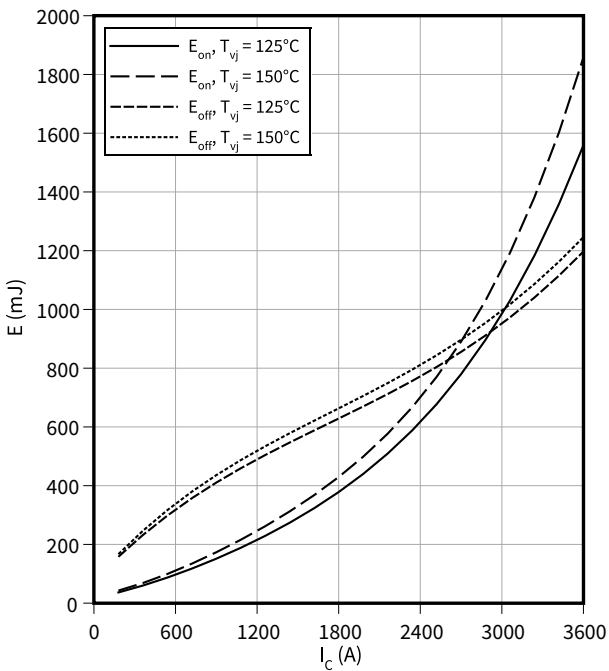

**Switching losses (typical), IGBT, 3-Level**

$E = f(R_G)$

$I_C = 1800 \text{ A}$ ,  $V_{CC} = 600 \text{ V}$ ,  $V_{GE} = \pm 15 \text{ V}$

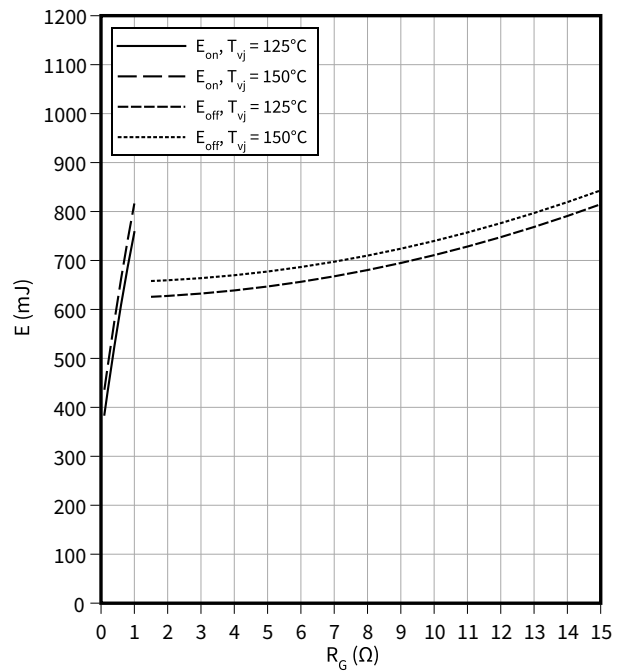

**Switching losses (typical), Diode, 3-Level**

$E_{rec} = f(I_F)$   
 $V_{CE} = 600\text{ V}, R_{Gon} = R_{Gon}(IGBT)$

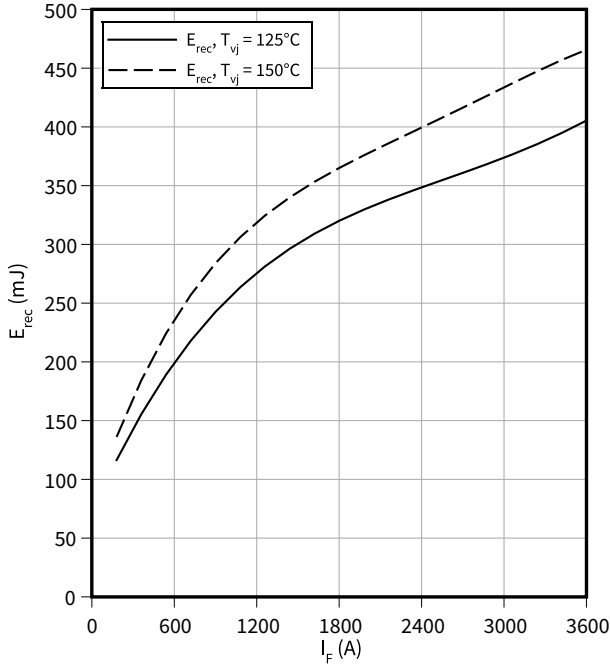

**Switching losses (typical), Diode, 3-Level**

$E_{rec} = f(R_G)$   
 $V_{CE} = 600\text{ V}, I_F = 1800\text{ A}$

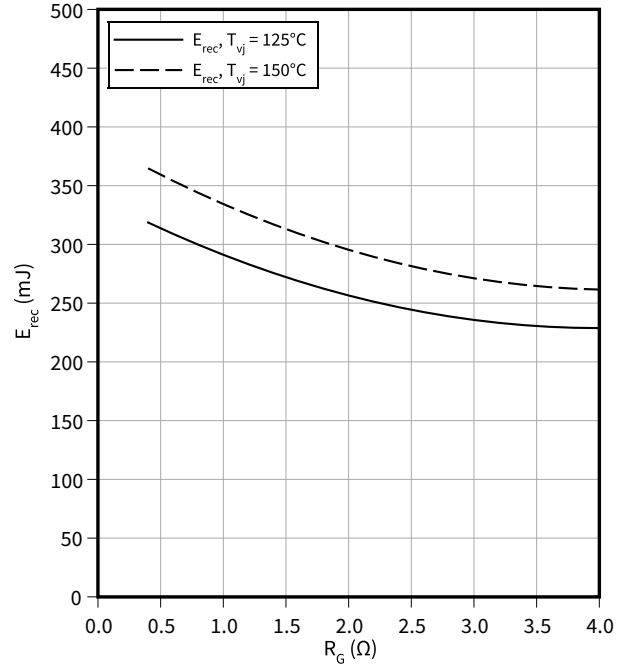

**Temperature characteristic (typical), NTC-Thermistor**

$R = f(T_{NTC})$

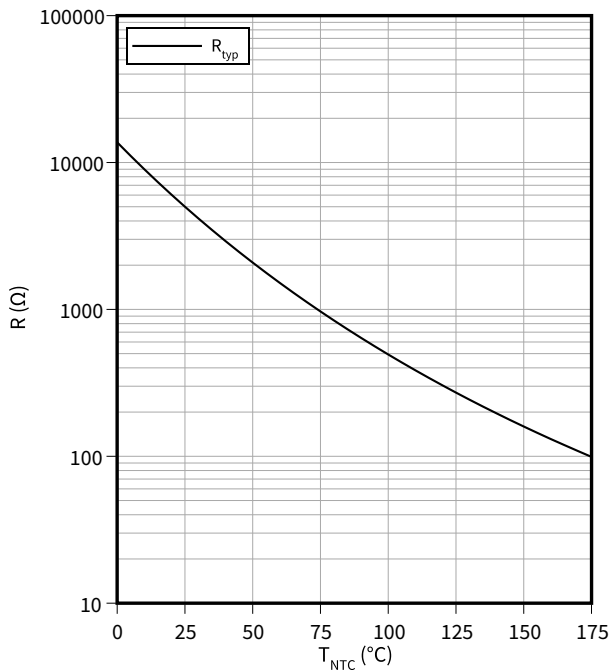

## 8 Circuit diagram

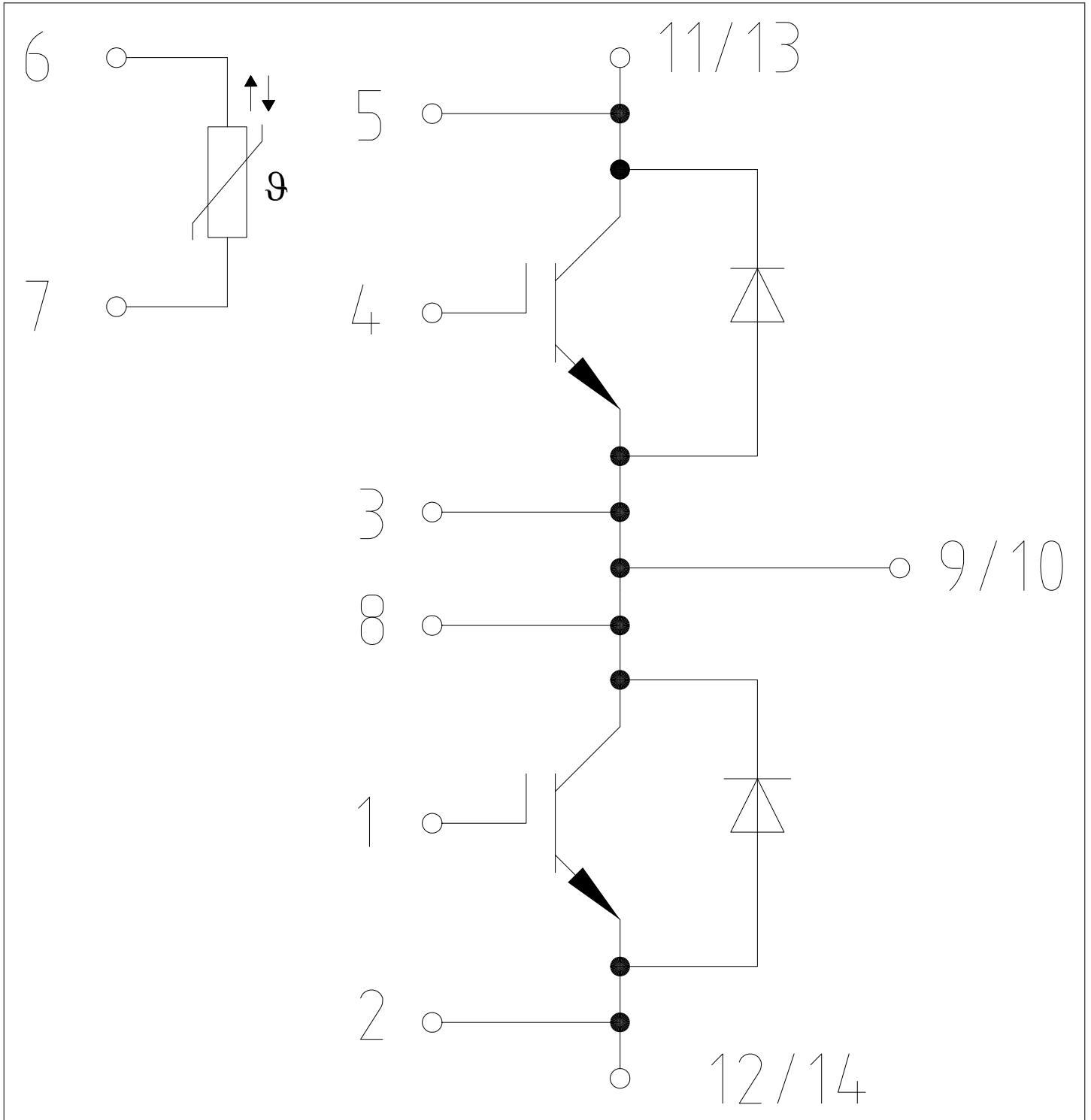

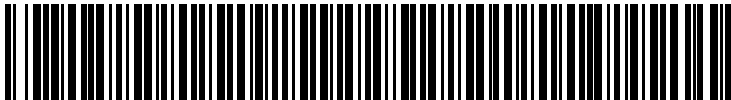

Figure 1





## 10 Module label code

Module label code			
Code format	Data Matrix	Barcode Code128	
Encoding	ASCII text	Code Set A	
Symbol size	16x16	23 digits	
Standard	IEC24720 and IEC16022	IEC8859-1	
Code content	<i>Content</i>	<i>Digit</i>	<i>Example</i>
	Module serial number	1 - 5	71549
	Module material number	6 - 11	142846
	Production order number	12 - 19	55054991
	Date code (production year)	20 - 21	15
	Date code (production week)	22 - 23	30
Example	 		
	71549142846550549911530		71549142846550549911530

**Figure 3**

## Revision history

Document revision	Date of release	Description of changes
1.00	2022-05-03	Final datasheet
1.10	2023-07-13	Final datasheet - Correction/ addition of capacity characteristics; Updates of commentary

## Trademarks

All referenced product or service names and trademarks are the property of their respective owners.

**Edition 2023-07-13**

**Published by**

**Infineon Technologies AG**

**81726 Munich, Germany**

**© 2023 Infineon Technologies AG**

**All Rights Reserved.**

**Do you have a question about any aspect of this document?**

**Email: [erratum@infineon.com](mailto:erratum@infineon.com)**

**Document reference**

**IFX-ABD865-002**

## Important notice

The information given in this document shall in no event be regarded as a guarantee of conditions or characteristics ("Beschaffheitsgarantie").

With respect to any examples, hints or any typical values stated herein and/or any information regarding the application of the product, Infineon Technologies hereby disclaims any and all warranties and liabilities of any kind, including without limitation warranties of non-infringement of intellectual property rights of any third party.

In addition, any information given in this document is subject to customer's compliance with its obligations stated in this document and any applicable legal requirements, norms and standards concerning customer's products and any use of the product of Infineon Technologies in customer's applications.

The data contained in this document is exclusively intended for technically trained staff. It is the responsibility of customer's technical departments to evaluate the suitability of the product for the intended application and the completeness of the product information given in this document with respect to such application.

Please note that this product is not qualified according to the AEC Q100 or AEC Q101 documents of the Automotive Electronics Council.

## Warnings

Due to technical requirements products may contain dangerous substances. For information on the types in question please contact your nearest Infineon Technologies office.

Except as otherwise explicitly approved by Infineon Technologies in a written document signed by authorized representatives of Infineon Technologies, Infineon Technologies' products may not be used in any applications where a failure of the product or any consequences of the use thereof can reasonably be expected to result in personal injury.