

Final datasheet
HybridPACK™ Drive G2 module with SiC MOSFET

Features

- Electrical features
 - $V_{DS} = 750\text{ V}$
 - $I_{DN} = 620\text{ A}$
 - New semiconductor material - silicon carbide
 - Low $R_{DS,on}$
 - Low switching losses
 - Low Q_g and C_{rSS}
 - Low inductive design
 - $T_{vj,op} = 175^\circ\text{C}$
 - Short-time extended operation temperature $T_{vj,op} = 200^\circ\text{C}$
- Mechanical features
 - 4.2 kV DC 1 second insulation
 - High creepage and clearance distances
 - Compact design
 - High power density
 - Direct-cooled PinFin base plate
 - High-performance Si_3N_4 ceramic
 - Guiding elements for PCB and cooler assembly
 - Integrated temperature sensing diode
 - PressFIT contact technology
 - RoHS compliant, lead-free
 - UL 94 V0 module frame

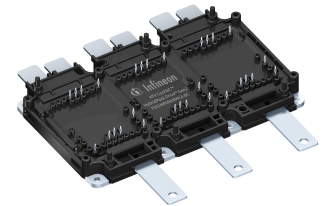

Potential applications

- Automotive applications
- (Hybrid) electrical vehicles (H)EV
- Motor drives
- Commercial, construction and agricultural vehicles (CAV)

Product validation

- Qualified according to AQG 324, release no.: 03.1/2021

Description

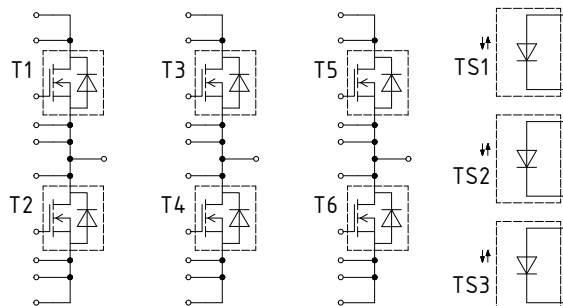

Table of contents

	Description	1
	Features	1
	Potential applications	1
	Product validation	1
	Table of contents	2
1	Package	3
2	MOSFET	4
3	Body diode (MOSFET)	6
4	Temperature sensor	7
5	Characteristics diagrams	8
6	Circuit diagram	14
7	Package outlines	15
8	Module label code	18
	Revision history	19
	Disclaimer	20

1 Package

Table 1 Insulation coordination

Parameter	Symbol	Note or test condition	Values	Unit
Isolation test voltage	V_{ISOL}	RMS, $f = 0$ Hz, $t = 1$ sec	4.20	kV
Material of module baseplate			Cu+Ni ¹⁾	
Internal isolation		basic insulation (class 1, IEC 61140)	Si ₃ N ₄	
Creepage distance	d_{creep}	terminal to heatsink	9.5	mm
Creepage distance	d_{creep}	terminal to terminal	9.5	mm
Clearance	d_{clear}	terminal to heatsink	4.5	mm
Clearance	d_{clear}	terminal to terminal	4.5	mm
Comparative tracking index	CTI		> 175	

1) Ni plated Cu baseplate

Table 2 Maximum rated values

Parameter	Symbol	Note or test condition	Values			Unit
			Min.	Typ.	Max.	
Maximum RMS module terminal current	$I_{t,rms}$		900			A
Heat-staking dome temperature ¹⁾	T_{HS}	$t_{staking} < 10s$			280	°C

1) Heat-staking according to application note AN-G2-ASSEMBLY.

Table 3 Characteristic values

Parameter	Symbol	Note or test condition	Values			Unit
			Min.	Typ.	Max.	
Pressure drop in cooling circuit	Δp	50% water / 50% ethylenglycol, $\Delta V/\Delta t = 10$ dm ³ /min, $T_f = 60$ °C		76 ¹⁾		mbar
Maximum pressure in cooling circuit	p	$T_{baseplate} < 40$ °C			3.0	bar
		$T_{baseplate} \geq 40$ °C (relative pressure)			2.5	
Stray inductance module	$L_{s,DS}$			8.0		nH
Module lead resistance, terminals - chip	$R_{DD'+SS'}$	$T_f = 25$ °C, per switch		0.64		mΩ
Storage temperature	T_{stg}		-40		125	°C
Mounting torque for module mounting ²⁾	M	Screw M4 baseplate to heatsink	1.8	2.0	2.2	Nm
		Screw EJOT Delta PCB to frame	0.45	0.50	0.55	
Weight	G			760		g

1) Cooler design and flow direction according to application note AN-G2-ASSEMBLY

2) Screw types and torque according to application note AN-G2-ASSEMBLY

2 MOSFET

Table 4 Maximum rated values

Parameter	Symbol	Note or test condition	Values			Unit
			Min.	Typ.	Max.	
Drain-source voltage	V_{DS}		continuous operation	750		V
			10h over life time	900		
DC drain current	$I_{D,nom}$	$V_{GS} = 18\text{ V}, T_f = 65\text{ °C}$			$T_{vj,max} = 175\text{ °C}$	A
Pulsed drain current	$I_{D,pulse}$	verified by design, t_p limited by $T_{vj,max}$		1240		A
Gate-source voltage, max. static voltage	V_{GS}			-5/19		V
Gate-source voltage, max. transient voltage	V_{GS}	Duty Cycle < 1 % (first transient maximum peak)		-10/23		V

Table 5 Recommended values

Parameter	Symbol	Note or test condition	Values	Unit
On-state gate voltage	$V_{GS(on)}$		15...18	V
Off-state gate voltage	$V_{GS(off)}$		-5...0	V

Table 6 Characteristic values

Parameter	Symbol	Note or test condition	Values			Unit	
			Min.	Typ.	Max.		
Drain-source on-resistance	$R_{DS,on}$	$I_D = 620\text{ A}, V_{GS} = 18\text{ V}$	$T_{vj} = 25\text{ °C}$	1.03	1.69	mΩ	
			$T_{vj} = 125\text{ °C}$	1.45			
			$T_{vj} = 175\text{ °C}$	1.80			
			$T_{vj} = 200\text{ °C}$	2.00			
Drain-source on-resistance	$R_{DS,on}$	$I_D = 620\text{ A}, V_{GS} = 15\text{ V}$	$T_{vj} = 25\text{ °C}$	1.28	2.00	mΩ	
			$T_{vj} = 125\text{ °C}$	1.65			
			$T_{vj} = 175\text{ °C}$	1.99			
			$T_{vj} = 200\text{ °C}$	2.21			
Gate threshold voltage	$V_{GS,th}$	$I_D = 200\text{ mA}, V_{GS} = V_{DS}$, (tested after 1ms pulse at $V_{GS} = +20\text{ V}$)	$T_{vj} = 25\text{ °C}$	3.20 ¹⁾	3.90	4.55	V
Total gate charge	Q_G	$V_{DS} = 470\text{ V}, V_{GS} = -5/18\text{ V}$		1.48			μC
Internal gate resistor	$R_{G,int}$		$T_{vj} = 25\text{ °C}$	0.53			Ω
Input capacitance	C_{iss}	$f = 1\text{ MHz}, V_{DS} = 470\text{ V}$	$T_{vj} = 25\text{ °C}$	43			nF
Output capacitance	C_{oss}	$f = 1\text{ MHz}, V_{DS} = 470\text{ V}$	$T_{vj} = 25\text{ °C}$	2.85			nF

(table continues...)

Table 6 (continued) Characteristic values

Parameter	Symbol	Note or test condition	Values			Unit
			Min.	Typ.	Max.	
Reverse transfer capacitance	C_{rSS}	$f = 1 \text{ MHz}, V_{DS} = 470 \text{ V}$	$T_{vj} = 25 \text{ °C}$	0.25		nF
C_{OSS} stored energy	E_{OSS}	$V_{DS} = 470 \text{ V}$	$T_{vj} = 25 \text{ °C}$	1250		μJ
Drain-source leakage current	I_{DSX}	$V_{GS} = -5 \text{ V}, V_{DSS} = 750 \text{ V}$	$T_{vj} = 25 \text{ °C}$		100	μA
Gate-source leakage current	I_{GSS}	$V_{GS} = 20 \text{ V}, V_{DS} = 0 \text{ V}$	$T_{vj} = 25 \text{ °C}$		100	nA
Turn-on delay time, inductive load	$t_{d,on}$	$I_D = 620 \text{ A}, R_{G,on} = 10.5 \text{ } \Omega, V_{GS} = -5/18 \text{ V}, V_{DS} = 470 \text{ V}$	$T_{vj} = 25 \text{ °C}$	128		ns
			$T_{vj} = 125 \text{ °C}$	107		
			$T_{vj} = 175 \text{ °C}$	99		
			$T_{vj} = 200 \text{ °C}$	96		
Rise time (inductive load)	t_r	$I_D = 620 \text{ A}, R_{G,on} = 10.5 \text{ } \Omega, V_{GS} = -5/18 \text{ V}, V_{DS} = 470 \text{ V}$	$T_{vj} = 25 \text{ °C}$	108		ns
			$T_{vj} = 125 \text{ °C}$	103		
			$T_{vj} = 175 \text{ °C}$	101		
			$T_{vj} = 200 \text{ °C}$	99		
Turn-off delay time, inductive load	$t_{d,off}$	$I_D = 620 \text{ A}, R_{G,off} = 4.2 \text{ } \Omega, V_{GS} = -5/18 \text{ V}, V_{DS} = 470 \text{ V}$	$T_{vj} = 25 \text{ °C}$	318		ns
			$T_{vj} = 125 \text{ °C}$	339		
			$T_{vj} = 175 \text{ °C}$	352		
			$T_{vj} = 200 \text{ °C}$	359		
Fall time (inductive load)	t_f	$I_D = 620 \text{ A}, R_{G,off} = 4.2 \text{ } \Omega, V_{GS} = -5/18 \text{ V}, V_{DS} = 470 \text{ V}$	$T_{vj} = 25 \text{ °C}$	53		ns
			$T_{vj} = 125 \text{ °C}$	57		
			$T_{vj} = 175 \text{ °C}$	58		
			$T_{vj} = 200 \text{ °C}$	59		
Turn-on energy loss per pulse	E_{on}	$I_D = 620 \text{ A}, R_{G,on} = 10.5 \text{ } \Omega, V_{GS} = -5/18 \text{ V}, V_{DS} = 470 \text{ V}, L_\sigma = 6.5 \text{ nH}$	$T_{vj} = 25 \text{ °C}, di/dt = 4.7 \text{ kA}/\mu\text{s}$	27.60		mJ
			$T_{vj} = 125 \text{ °C}, di/dt = 4.9 \text{ kA}/\mu\text{s}$	26.40		
			$T_{vj} = 175 \text{ °C}, di/dt = 5 \text{ kA}/\mu\text{s}$	26.30		
			$T_{vj} = 200 \text{ °C}, di/dt = 5 \text{ kA}/\mu\text{s}$	26.30		

(table continues...)

Table 6 (continued) **Characteristic values**

Parameter	Symbol	Note or test condition	Values			Unit	
			Min.	Typ.	Max.		
Turn-off energy loss per pulse	E_{off}	$I_D = 620\text{ A}$, $R_{G,off} = 4.2\ \Omega$, $V_{GS} = -5/18\text{ V}$, $V_{DS} = 470\text{ V}$, $L_\sigma = 6.5\text{ nH}$	$T_{vj} = 25\text{ °C}$, $du/dt = 6\text{ kV}/\mu\text{s}$		22.90		mJ
			$T_{vj} = 125\text{ °C}$, $du/dt = 5.9\text{ kV}/\mu\text{s}$		23.80		
			$T_{vj} = 175\text{ °C}$, $du/dt = 5.8\text{ kV}/\mu\text{s}$		24.30		
			$T_{vj} = 200\text{ °C}$, $du/dt = 5.8\text{ kV}/\mu\text{s}$		24.50		
Short circuit data	I_{SC}	$V_{DD} = 470\text{ V}$, $V_{GS} = -5/18\text{ V}$, $R_{G,on} = 10.5\ \Omega$, $R_{G,off} = 4.2\ \Omega$, $V_{DSmax} =$ $V_{DSS} - L_{SDS} \cdot di/dt$	$t_{SC} = 1.2\ \mu\text{s}$, $T_{vj} = 200\text{ °C}$		10000		A
Short circuit data	I_{SC}	$V_{DD} = 470\text{ V}$, $V_{GS} = -5/15\text{ V}$, $R_{G,on} = 10.5\ \Omega$, $R_{G,off} = 4.2\ \Omega$, $V_{DSmax} =$ $V_{DSS} - L_{SDS} \cdot di/dt$	$t_{SC} = 2\ \mu\text{s}$, $T_{vj} = 200\text{ °C}$		6500		A
Thermal resistance, junction to cooling fluid ²⁾	$R_{th,j-f}$	per MOSFET, 50% water / 50% ethylenglycol, $\Delta V/\Delta t = 10\text{ dm}^3/\text{min}$, $T_f = 60\text{ °C}$			0.107	0.118 ³⁾	K/W
Temperature under switching conditions	$T_{vj,op}$	continuous operation		-40		175	°C
		extended operation				200 ⁴⁾	

- 1) At 0h operating time. During inverter operation the value can be lower depending on T_{vj} , $V_{GS(off)}$, (switching frequency) f_{sw} over lifetime. For a final assessment of $V_{GS,th}$ Min. value depending on customer application please contact the Infineon sales office for the necessary technical support by Infineon.
- 2) Cooler design and flow direction according to application note AN-G2-ASSEMBLY
- 3) EoL criteria see AQG324, verified by characterization with 4.5 sigma
- 4) For 100h cumulated over life time

3 Body diode (MOSFET)

Table 7 **Maximum rated values**

Parameter	Symbol	Note or test condition	Values	Unit	
Drain-source voltage	V_{DSS}		continuous operation	750	V
			10h over life time	900	
DC body diode forward current	$I_{F,S}$	$T_{vj,max} = 175\text{ °C}$, $V_{GS} = -5\text{ V}$	$T_f = 65\text{ °C}$	170	A
Pulsed body diode current	$I_{F,S,pulse}$	verified by design, t_p limited by $T_{vj,max}$		1240	A

Table 8 Characteristic values

Parameter	Symbol	Note or test condition	Values			Unit	
			Min.	Typ.	Max.		
Forward voltage	$V_{F,SD}$	$I_{F,S} = 620 \text{ A}, V_{GS} = -5 \text{ V}$	$T_{vj} = 25 \text{ °C}$		4.64	6.73	V
			$T_{vj} = 125 \text{ °C}$		4.25		
			$T_{vj} = 175 \text{ °C}$		4.09		
			$T_{vj} = 200 \text{ °C}$		4.04		
Peak reverse recovery current	I_{rrm}	$I_{F,S} = 620 \text{ A}, V_{GS} = -5 \text{ V}, V_{R,DS} = 470 \text{ V}$	$T_{vj} = 25 \text{ °C}$		117		A
			$T_{vj} = 125 \text{ °C}$		133		
			$T_{vj} = 175 \text{ °C}$		152		
			$T_{vj} = 200 \text{ °C}$		162		
Recovered charge	Q_{rr}	$I_{F,S} = 620 \text{ A}, V_{GS} = -5 \text{ V}, V_{R,DS} = 470 \text{ V}$	$T_{vj} = 25 \text{ °C}$		2.20		μC
			$T_{vj} = 125 \text{ °C}$		3.60		
			$T_{vj} = 175 \text{ °C}$		5.00		
			$T_{vj} = 200 \text{ °C}$		5.70		
Reverse recovery energy	E_{rec}	$I_{F,S} = 620 \text{ A}, V_{GS} = -5 \text{ V}, V_{R,DS} = 470 \text{ V}$	$T_{vj} = 25 \text{ °C}, -di/dt = 5.4 \text{ kA}/\mu\text{s}$		0.3		mJ
			$T_{vj} = 125 \text{ °C}, -di/dt = 5.6 \text{ kA}/\mu\text{s}$		0.5		
			$T_{vj} = 175 \text{ °C}, -di/dt = 5.7 \text{ kA}/\mu\text{s}$		0.8		
			$T_{vj} = 200 \text{ °C}, -di/dt = 5.8 \text{ kA}/\mu\text{s}$		0.9		

4 Temperature sensor

Table 9 Characteristic values

Parameter	Symbol	Note or test condition	Values			Unit	
			Min.	Typ.	Max.		
Transient sense current	I_{TS}				10	mA	
Forward voltage	V_{TS}		$I_{TS} = 0.2 \text{ mA}, T_{vj} = 25 \text{ °C}$	2.574	2.624	2.674	V
			$I_{TS} = 0.2 \text{ mA}, T_{vj} = 85 \text{ °C}$	2.169	2.234	2.299	

5 Characteristics diagrams

Pressure drop in cooling circuit (typical), Package

$$\Delta p = f(\Delta V/\Delta t)$$

fluid = 50% water / 50% ethylenglycol , $T_f = 60\text{ °C}$

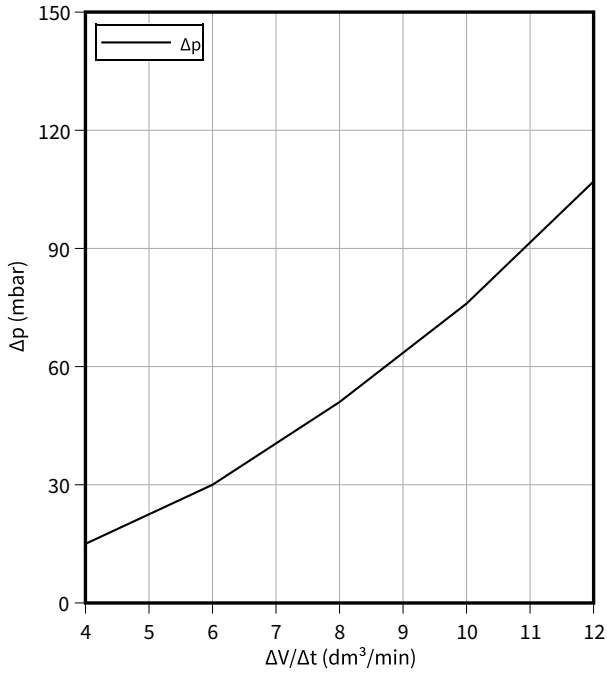

Maximum allowed drain-source voltage, MOSFET

$$V_{DSS} = f(T_{vj})$$

verified by characterization / design, not by test

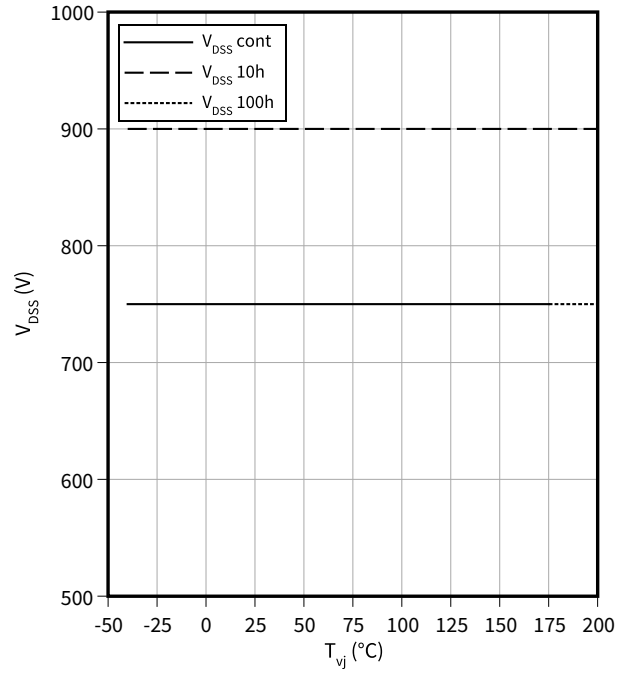

Output characteristic (typical), MOSFET

$$I_D = f(V_{DS})$$

$V_{GS} = 18\text{ V}$

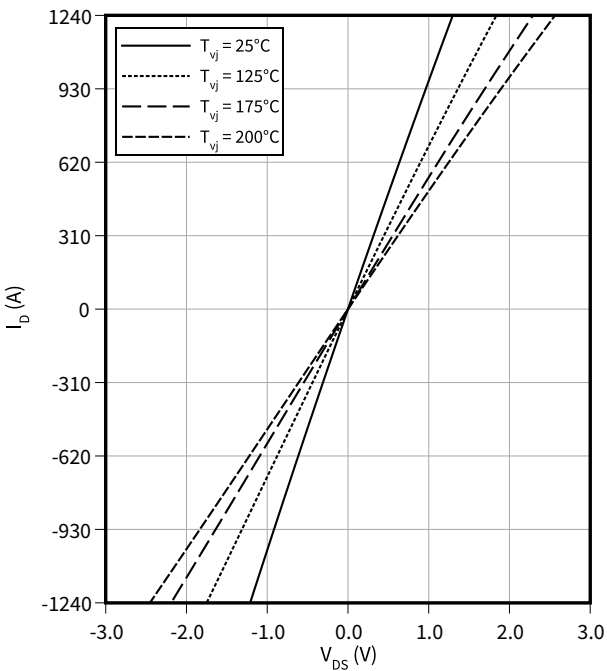

Output characteristic (typical), MOSFET

$$I_D = f(V_{DS})$$

$T_{vj} = 25\text{ °C}$

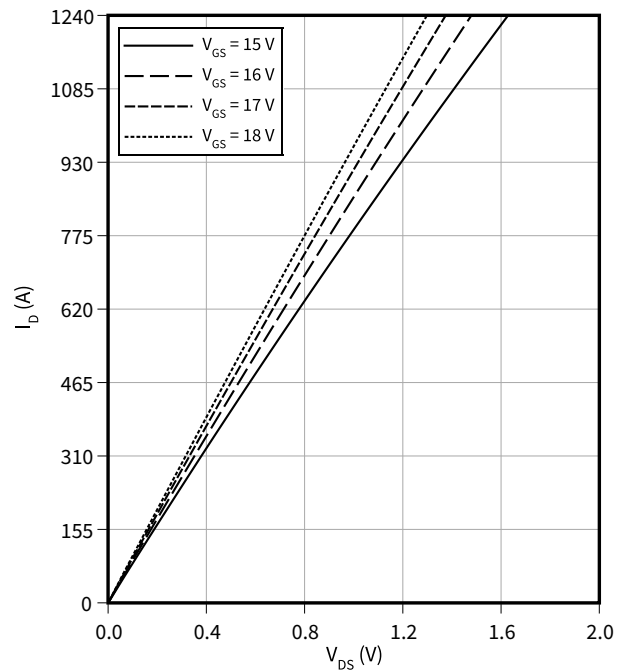

5 Characteristics diagrams

Drain-source on-resistance (typical), MOSFET

$R_{DS,on} = f(T_{vj})$
 $I_D = 620 \text{ A}, V_{GS} = 18 \text{ V}$

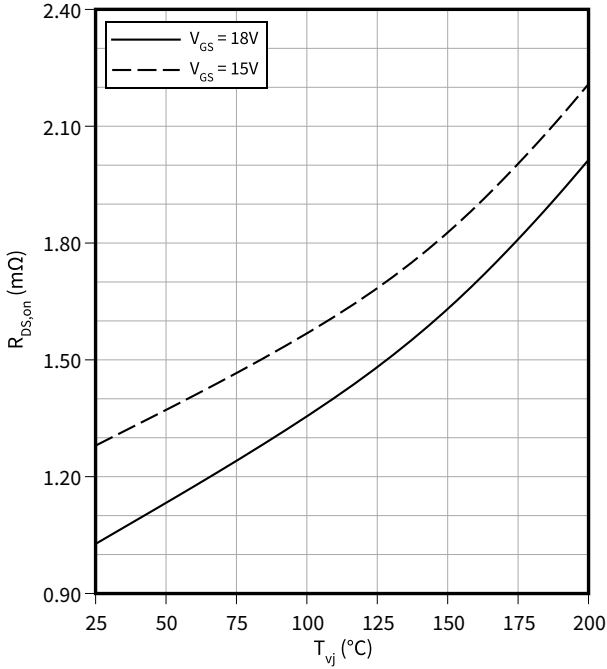

Drain-source on-resistance (typical), MOSFET

$R_{DS,on} = f(I_D)$
 $V_{GS} = 18 \text{ V}$

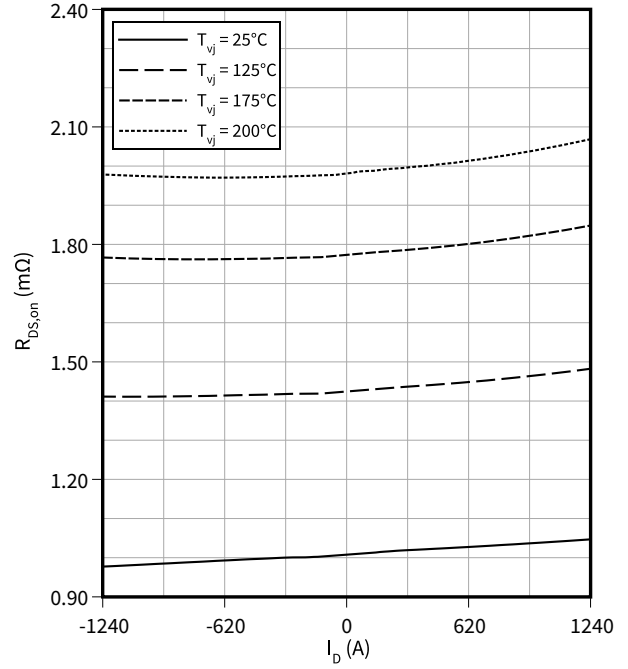

Transfer characteristic (typical), MOSFET

$I_D = f(V_{GS})$
 $V_{DS} = 20 \text{ V}$

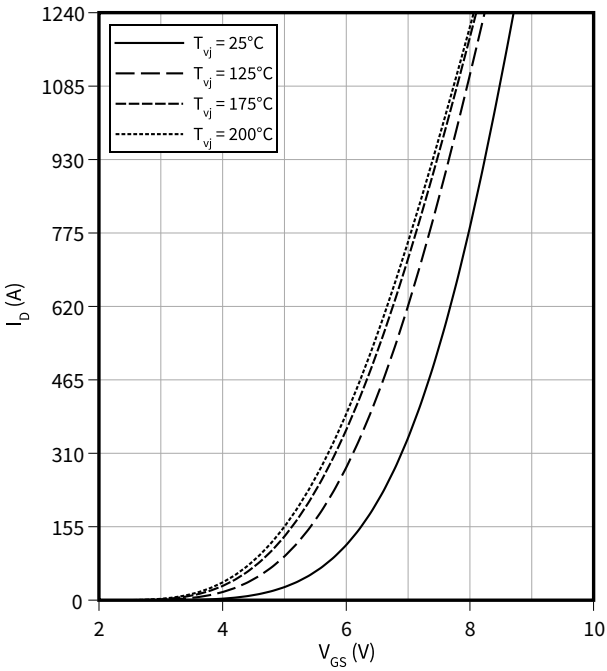

Gate charge characteristic (typical), MOSFET

$V_{GS} = f(Q_G)$
 $V_{DD} = 470 \text{ V}, T_{vj} = 25 \text{ }^{\circ}C$

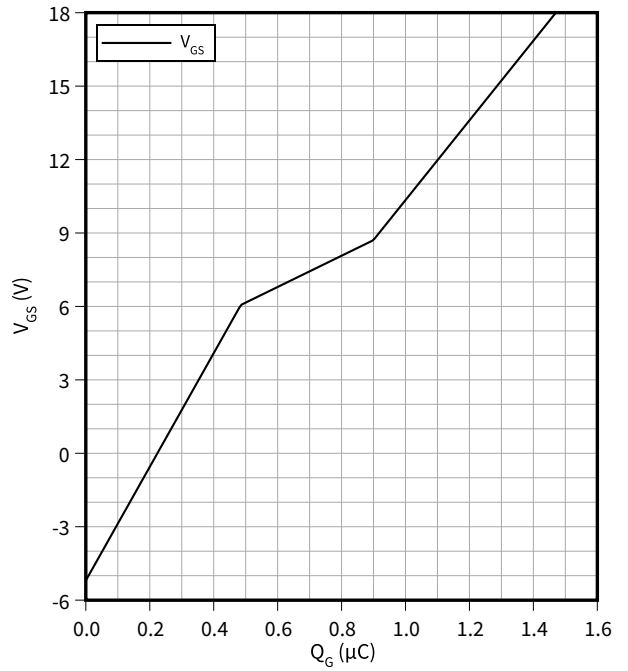

5 Characteristics diagrams

Capacity characteristic (typical), MOSFET

$C = f(V_{DS})$

$f = 1 \text{ MHz}, V_{GS} = -5/18 \text{ V}, T_{vj} = 25 \text{ }^\circ\text{C}$

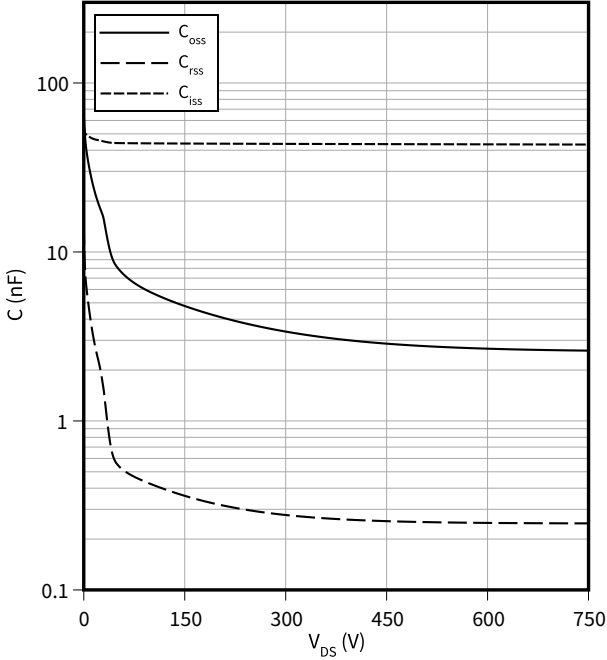

Switching losses (typical), MOSFET

$E = f(I_D)$

$V_{DS} = 470 \text{ V}, R_{G,off} = 4.2 \text{ } \Omega, R_{G,on} = 10.5 \text{ } \Omega, V_{GS} = -5/18 \text{ V}$

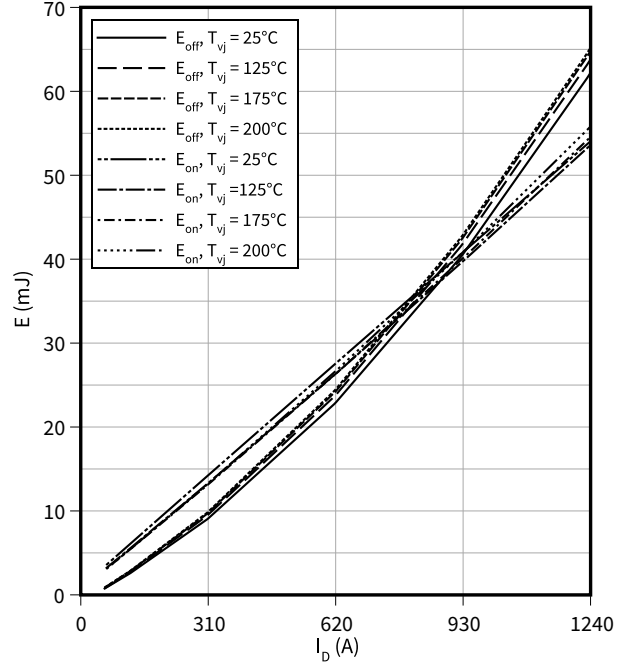

Switching losses (typical), MOSFET

$E = f(R_G)$

$I_D = 620 \text{ A}, V_{DS} = 470 \text{ V}, V_{GS} = -5/18 \text{ V}$

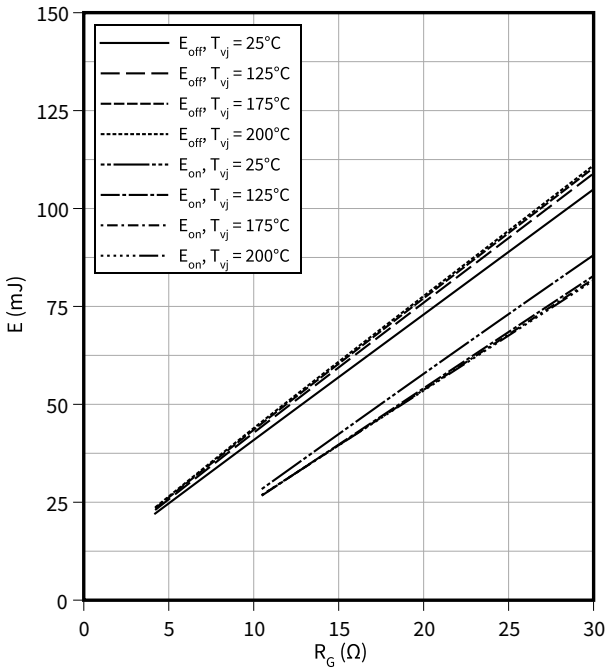

Current slope (typical), MOSFET

$di/dt = f(I_D)$

$V_{DS} = 470 \text{ V}, R_{G,off} = 4.2 \text{ } \Omega, R_{G,on} = 10.5 \text{ } \Omega, V_{GS} = -5/18 \text{ V}$

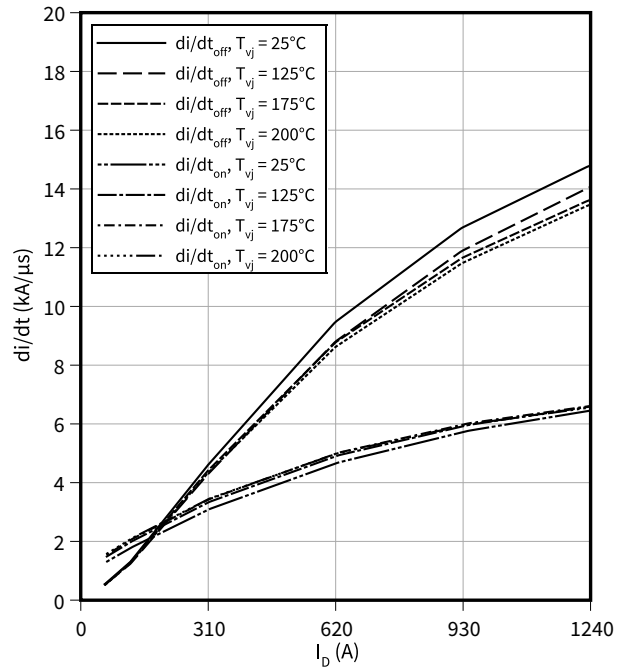

5 Characteristics diagrams

Current slope (typical), MOSFET

$di/dt = f(R_G)$

$V_{DS} = 470 \text{ V}$, $I_D = 620 \text{ A}$, $V_{GS} = -5/18 \text{ V}$

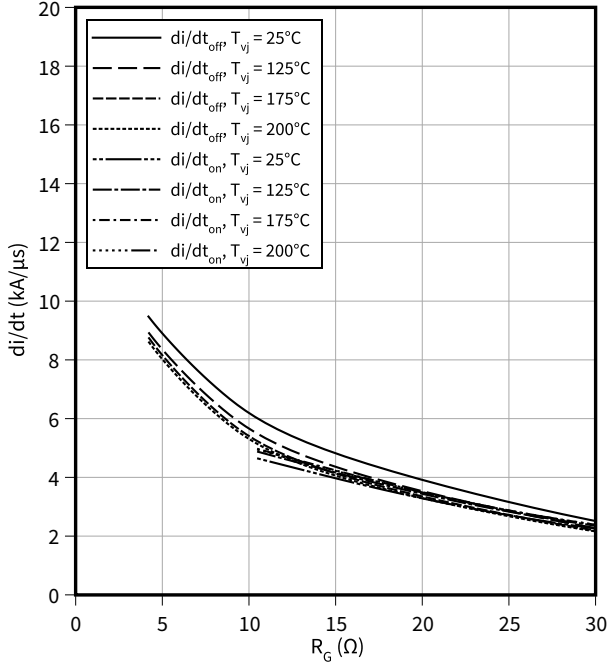

Voltage slope (typical), MOSFET

$dv/dt = f(I_D)$

$V_{DS} = 470 \text{ V}$, $R_{G,off} = 4.2 \text{ Ω}$, $R_{G,on} = 10.5 \text{ Ω}$, $V_{GS} = -5/18 \text{ V}$

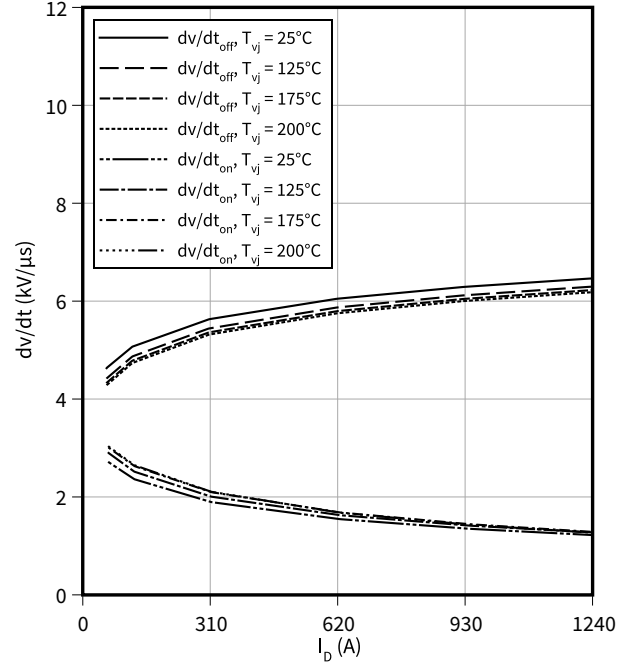

Voltage slope (typical), MOSFET

$dv/dt = f(R_G)$

$I_D = 620 \text{ A}$, $V_{DS} = 470 \text{ V}$, $V_{GS} = -5/18 \text{ V}$

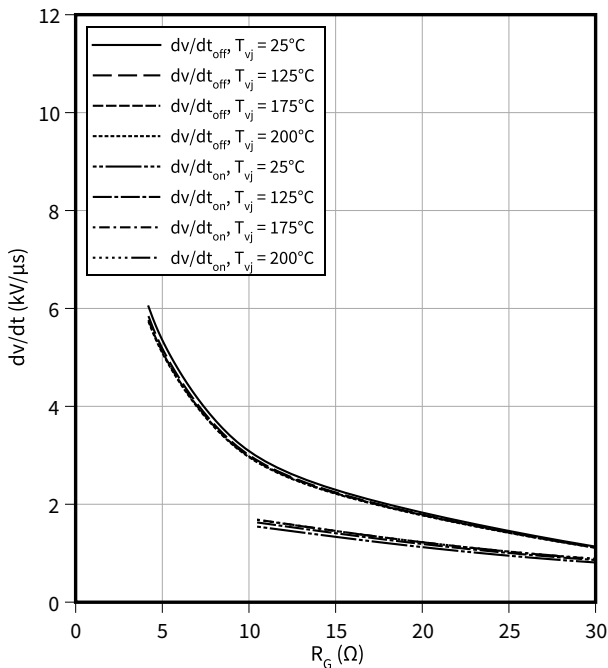

Reverse bias safe operating area (RBSOA), MOSFET

$I_D = f(V_{DS})$

$R_{G,off} = 4.2 \text{ Ω}$, $V_{GS} = +18/-5 \text{ V}$, $T_{vj} = 175 \text{ °C}$

(1) for 10h over lifetime

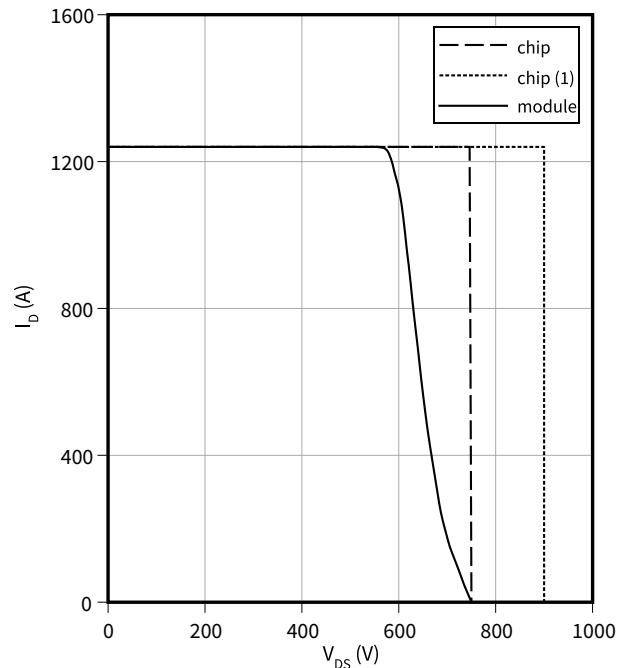

5 Characteristics diagrams

Transient thermal impedance (typical), MOSFET

$Z_{th} = f(t)$

$\Delta V/\Delta t = 10 \text{ dm}^3/\text{min}$, fluid = 50% water/50% ethylenglycol, $T_f = 60 \text{ }^\circ\text{C}$

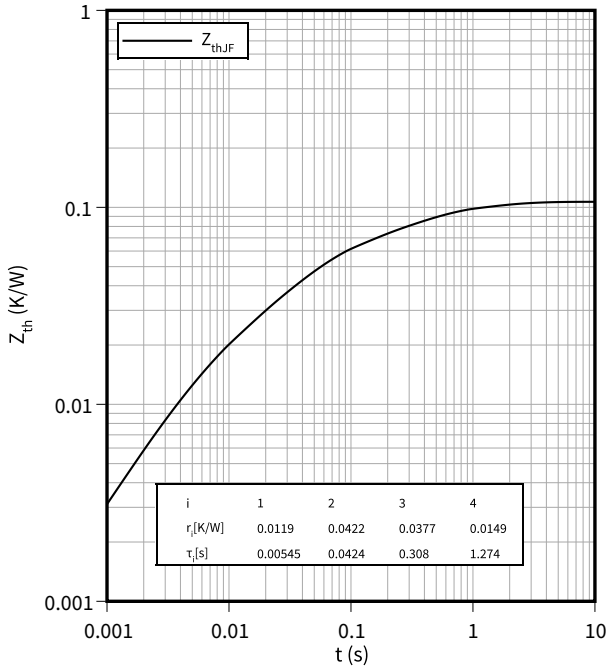

Thermal impedance (typical), MOSFET

$R_{th,j-f} = f(dv/dt)$

fluid = 50% water/50% ethylenglycol, $T_f = 60 \text{ }^\circ\text{C}$

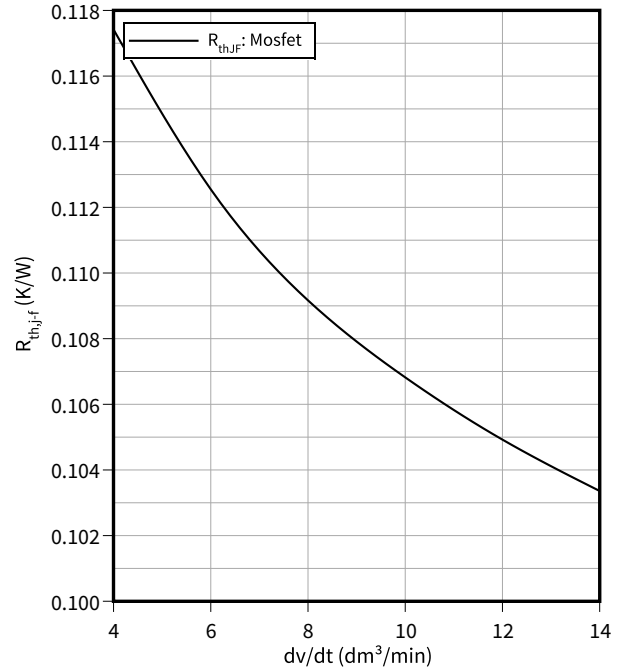

Forward characteristic body diode (typical), MOSFET

$I_{F,S} = f(V_{SD})$

$T_{vj} = 25 \text{ }^\circ\text{C}$

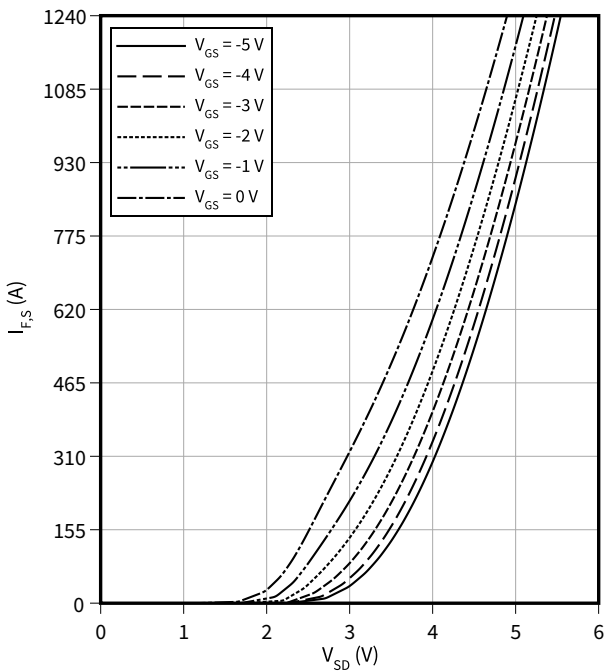

Forward characteristic body diode (typical), MOSFET

$I_{F,S} = f(V_{SD})$

$V_{GS} = -5 \text{ V}$

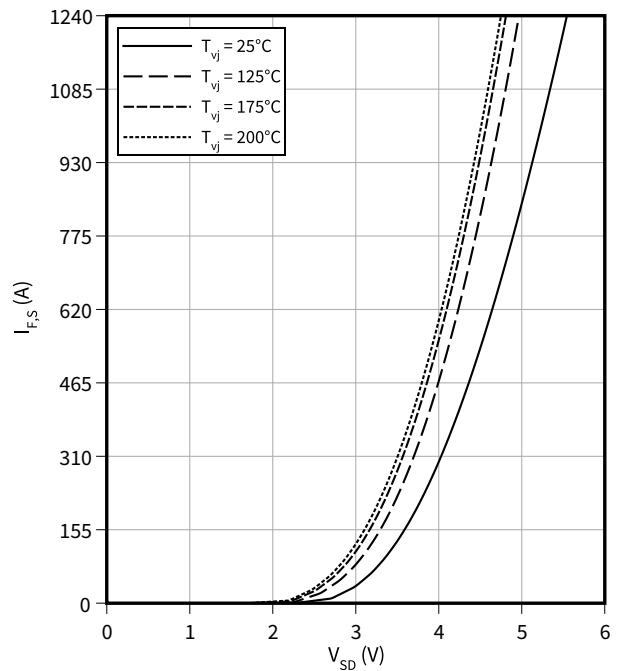

5 Characteristics diagrams

Switching losses body diode (typical), MOSFET

$E_{rec} = f(I_{SD})$

$V_r = 470\text{ V}, R_{G,on} = 10.5\ \Omega$

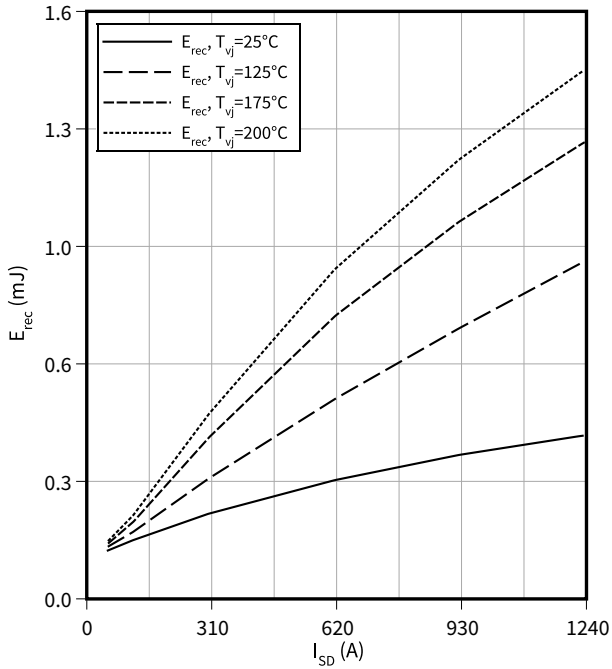

Switching losses body diode (typical), MOSFET

$E_{rec} = f(R_G)$

$V_r = 470\text{ V}, I_{F,S} = 620\text{ A}$

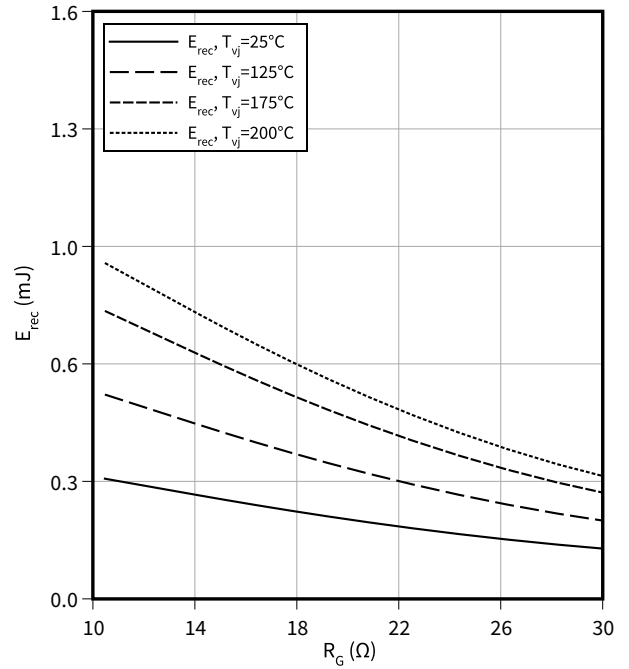

Temperature characteristic (typical), Temperature sensor

$V_{TS} = f(T_{vj})$

$I_{TS} = 0.2\text{ mA}$

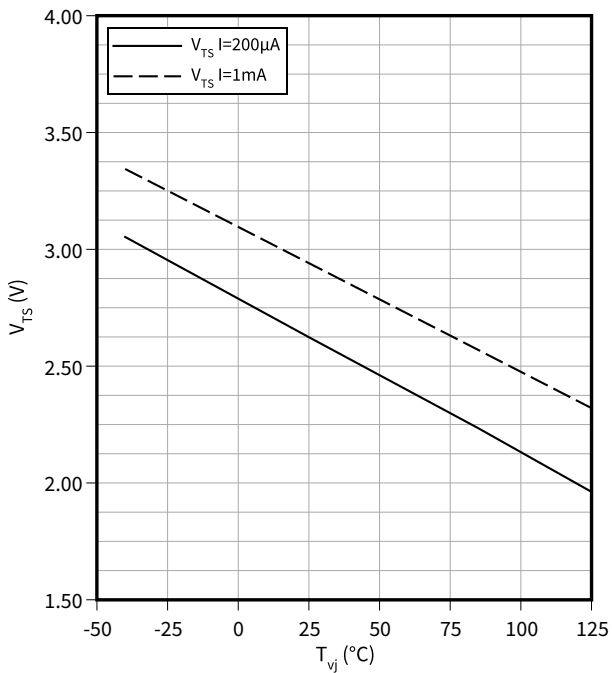

6 Circuit diagram

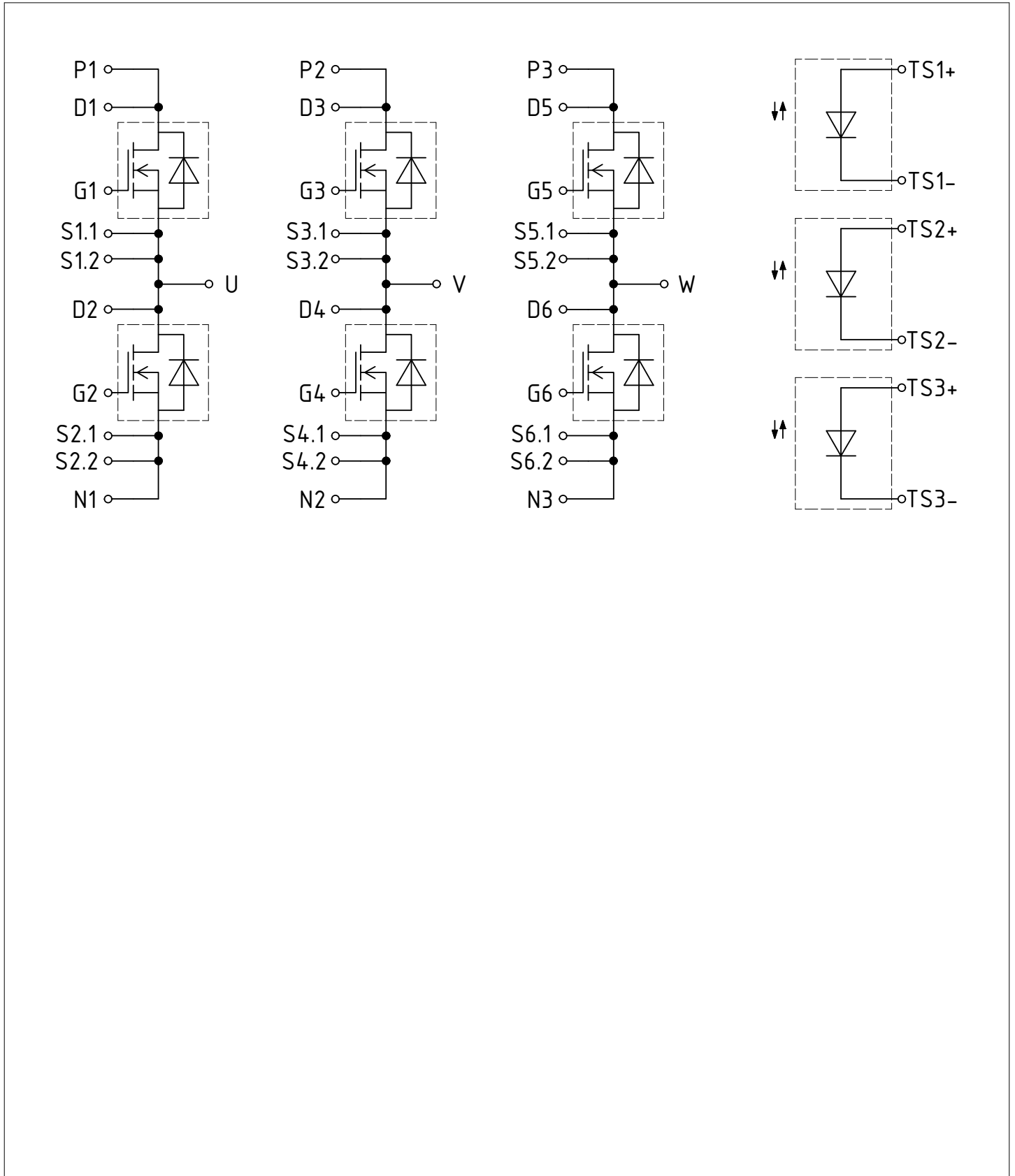

Figure 1

7 Package outlines

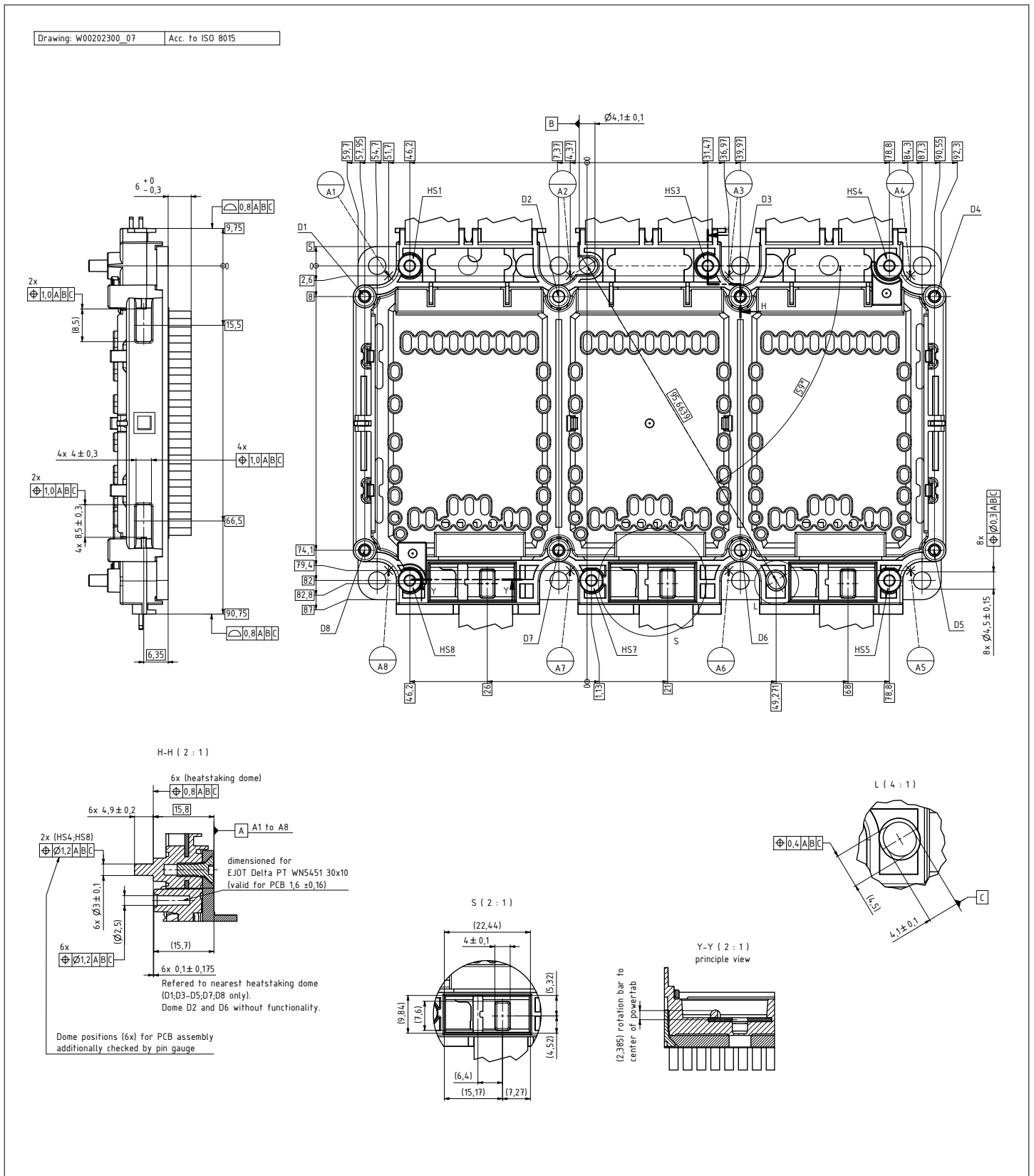

Figure 2

7 Package outlines

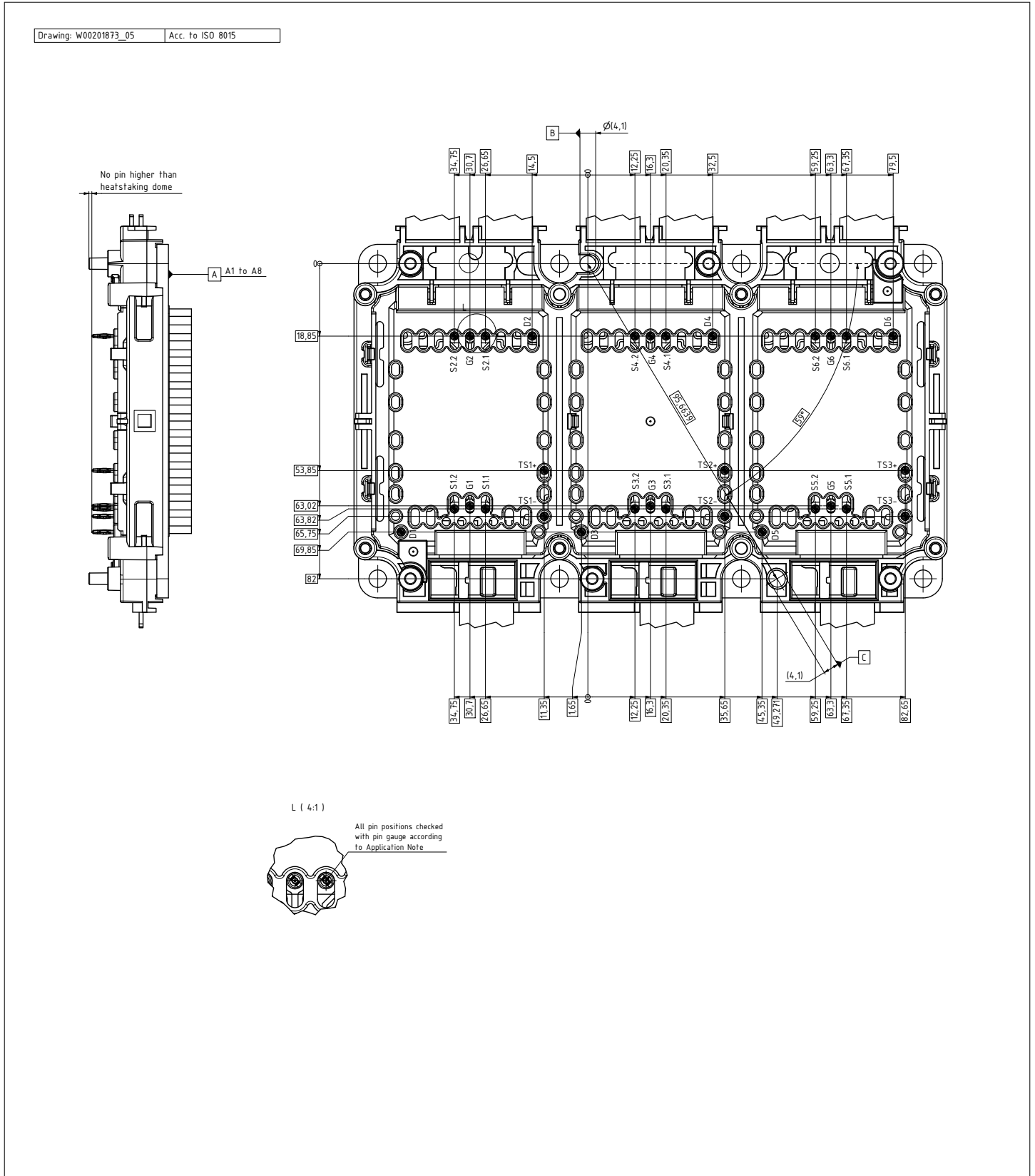

Figure 4

8 Module label code



Module label code				
Code format	Data Matrix	Barcode Code128		
Encoding	ASCII text	Code Set A		
Symbol size	16x16	23 digits		
Standard	IEC24720 and IEC16022	IEC8859-1		
Code content	<i>Content</i>	<i>Digit</i>	<i>Example</i>	
	Module serial number	1 - 5	71549	
	Module material number	6 - 11	142846	
	Production order number	12 - 19	55054991	
	Date code (production year)	20 - 21	15	
	Date code (production week)	22 - 23	30	
Example				
	71549142846550549911530		71549142846550549911530	
Packing label code				
Code format	Barcode Code128			
Encoding	Code Set A			
Symbol size	34 digits			
Standard	IEC8859-1			
Code content	<i>Content</i>	<i>Identifier</i>	<i>Digit</i>	<i>Example</i>
	Module serial number	X	2 - 9	95056609
	Module material number	1T	12 - 19	2X0003E0
	Production order number	S	21 - 25	754389
	Date code (production year)	9D	28 - 31	1139
	Date code (production week)	Q	33 - 34	15
Example				
	X950566091T2X0003E0S754389D1139Q15			

Figure 5

Revision history

Document revision	Date of release	Description of changes
0.10	2022-04-06	Initial version
0.11	2023-01-19	Target datasheet
0.20	2023-06-20	Preliminary datasheet
1.00	2024-03-14	Final datasheet

Trademarks

All referenced product or service names and trademarks are the property of their respective owners.

Edition 2024-03-14

Published by

Infineon Technologies AG

81726 Munich, Germany

© 2024 Infineon Technologies AG

All Rights Reserved.

Do you have a question about any aspect of this document?

Email: erratum@infineon.com

Document reference

IFX-ABD901-004

Important notice

The information given in this document shall in no event be regarded as a guarantee of conditions or characteristics ("Beschaffheitsgarantie").

With respect to any examples, hints or any typical values stated herein and/or any information regarding the application of the product, Infineon Technologies hereby disclaims any and all warranties and liabilities of any kind, including without limitation warranties of non-infringement of intellectual property rights of any third party.

In addition, any information given in this document is subject to customer's compliance with its obligations stated in this document and any applicable legal requirements, norms and standards concerning customer's products and any use of the product of Infineon Technologies in customer's applications.

The data contained in this document is exclusively intended for technically trained staff. It is the responsibility of customer's technical departments to evaluate the suitability of the product for the intended application and the completeness of the product information given in this document with respect to such application.

Warnings

Due to technical requirements products may contain dangerous substances. For information on the types in question please contact your nearest Infineon Technologies office.

Except as otherwise explicitly approved by Infineon Technologies in a written document signed by authorized representatives of Infineon Technologies, Infineon Technologies' products may not be used in any applications where a failure of the product or any consequences of the use thereof can reasonably be expected to result in personal injury.