



Please note that GaN Systems is an Infineon Technologies Company

The document following this cover page is marked as “GaN Systems” document as this is the company that originally developed the product. Please note that Infineon will continue to offer the product to new and existing customers as part of the Infineon product portfolio.

Continuity of document content

The fact that Infineon offers the following product as part of the Infineon product portfolio does not lead to any changes to this document. Future revisions will occur when appropriate, and any changes will be set out on the document history page.

Continuity of ordering part numbers

Infineon continues to support existing part numbers. Please continue to use the ordering part numbers listed in the datasheet for ordering.

Features

- 100 V enhancement mode power-transistor
- Bottom-side cooled configuration
- $R_{DS(on)} = 7 \text{ m}\Omega$
- $I_{DS(max)} = 90 \text{ A}$
- Ultra-low FOM die
- Low inductance GaN^{PX}® package
- Simple gate drive requirements (0 V to 6 V)
- Transient tolerant gate drive (-20 V / +10 V)
- Very high switching frequency (> 10 MHz)
- Fast and controllable fall and rise times
- Reverse current capability
- Zero reverse recovery loss
- Small 7.6 x 4.6 mm² PCB footprint
- Source Sense (SS) pin for optimized gate drive
- RoHS 3 (6 + 4) compliant



Package Outline

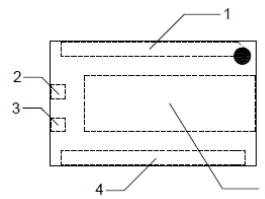

Circuit Symbol

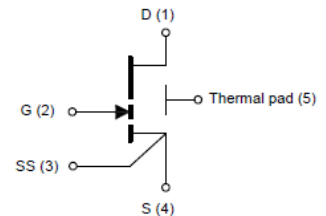

The thermal pad (pad 5) must be connected to Source, S (pad 4)

Applications

- Energy Storage Systems
- AC-DC Converters (secondary side)
- Uninterruptable Power Supplies
- Industrial Motor Drives
- Fast Battery Charging
- Class D Audio amplifiers
- Traction Drive
- Robotics
- Wireless Power Transfer

Description

The GS61008P is an enhancement mode GaN-on-silicon power transistor. The properties of GaN allow for high current, high voltage breakdown and high switching frequency. GaN Systems innovates with industry leading advancements such as patented **Island Technology**® and **GaN^{PX}**® packaging. **Island Technology**® cell layout realizes high-current die and high yield. **GaN^{PX}**® packaging enables low inductance & low thermal resistance in a small package. The GS61008P is a bottom-side cooled transistor that offers very low junction-to-case thermal resistance for demanding high power applications. These features combine to provide very high efficiency power switching.

Absolute Maximum Ratings ($T_{case} = 25\text{ }^{\circ}\text{C}$ except as noted)

Parameter	Symbol	Value	Unit
Operating Junction Temperature	T_J	-55 to +150	$^{\circ}\text{C}$
Storage Temperature Range	T_S	-55 to +150	$^{\circ}\text{C}$
Drain-to-Source Voltage	V_{DS}	100	V
Drain-to-Source Voltage - transient (Note 1)	$V_{DS(transient)}$	120	V
Gate-to-Source Voltage	V_{GS}	-10 to +7	V
Gate-to-Source Voltage - transient (Note 1)	$V_{GS(transient)}$	-20 to +10	V
Continuous Drain Current ($T_{case} = 25\text{ }^{\circ}\text{C}$)	I_{DS}	90	A
Continuous Drain Current ($T_{case} = 100\text{ }^{\circ}\text{C}$)	I_{DS}	65	A
Pulse Drain Current (Pulse width 50 μs , $V_{GS} = 6\text{ V}$) (Note 2)	$I_{DS\text{ Pulse}}$	140	A

(1) For $\leq 1\text{ }\mu\text{s}$

(2) Defined by product design and characterization. Value is not tested to full current in production.

Thermal Characteristics (Typical values unless otherwise noted)

Parameter	Symbol	Value	Units
Thermal Resistance (junction-to-case) – bottom side	$R_{\theta JC}$	0.55	$^{\circ}\text{C}/\text{W}$
Thermal Resistance (junction-to-ambient) (Note 3)	$R_{\theta JA}$	23	$^{\circ}\text{C}/\text{W}$
Maximum Soldering Temperature (MSL3 rated)	T_{SOLD}	260	$^{\circ}\text{C}$

(3) Device mounted on 1.6 mm PCB thickness FR4, 4-layer PCB with 2 oz. copper on each layer. The recommendation for thermal vias under the thermal pad are 0.3 mm diameter (12 mil) with 0.635 mm pitch (25 mil). The copper layers under the thermal pad and drain pad are 25 x 25 mm² each. The PCB is mounted in horizontal position without air stream cooling.

Ordering Information

Ordering code	Package type	Packing method	Qty	Reel Diameter	Reel Width
GS61008P-TR	GaNPX [®] bottom cooled	Tape-and-Reel	3000	13" (330mm)	16mm
GS61008P-MR	GaNPX [®] bottom cooled	Mini-Reel	250	7" (180mm)	16mm

Electrical Characteristics (Typical values at $T_J = 25\text{ }^\circ\text{C}$, $V_{GS} = 6\text{ V}$ unless otherwise noted)

Parameters	Sym.	Min.	Typ.	Max.	Units	Conditions
Drain-to-Source Blocking Voltage	$V_{(BL)DSS}$	100			V	$V_{GS} = 0\text{ V}$, $I_{DSS} = 50\text{ }\mu\text{A}$
Drain-to-Source On Resistance	$R_{DS(on)}$		7	9.5	$\text{m}\Omega$	$V_{GS} = 6\text{ V}$, $T_J = 25\text{ }^\circ\text{C}$ $I_{DS} = 27\text{ A}$
Drain-to-Source On Resistance	$R_{DS(on)}$		17.5		$\text{m}\Omega$	$V_{GS} = 6\text{ V}$, $T_J = 150\text{ }^\circ\text{C}$ $I_{DS} = 27\text{ A}$
Gate-to-Source Threshold	$V_{GS(th)}$	1.1	1.7	2.6	V	$V_{DS} = V_{GS}$, $I_{DS} = 7\text{ mA}$
Gate-to-Source Current	I_{GS}		200		μA	$V_{GS} = 6\text{ V}$, $V_{DS} = 0\text{ V}$
Gate Plateau Voltage	V_{plat}		3.5		V	$V_{DS} = 50\text{ V}$, $I_{DS} = 90\text{ A}$
Drain-to-Source Leakage Current	I_{DSS}		0.5	50	μA	$V_{DS} = 100\text{ V}$, $V_{GS} = 0\text{ V}$ $T_J = 25\text{ }^\circ\text{C}$
Drain-to-Source Leakage Current	I_{DSS}		100		μA	$V_{DS} = 100\text{ V}$, $V_{GS} = 0\text{ V}$ $T_J = 150\text{ }^\circ\text{C}$
Internal Gate Resistance	R_G		0.8		Ω	$f = 5\text{ MHz}$, open drain
Input Capacitance	C_{ISS}		600		pF	$V_{DS} = 50\text{ V}$ $V_{GS} = 0\text{ V}$ $f = 100\text{ kHz}$
Output Capacitance	C_{OSS}		250		pF	
Reverse Transfer Capacitance	C_{RSS}		12		pF	
Effective Output Capacitance, Energy Related (Note 4)	$C_{O(ER)}$		302		pF	$V_{GS} = 0\text{ V}$ $V_{DS} = 0\text{ to }50\text{ V}$
Effective Output Capacitance, Time Related (Note 5)	$C_{O(TR)}$		385		pF	
Total Gate Charge	Q_G		8		nC	$V_{GS} = 0\text{ to }6\text{ V}$ $V_{DS} = 50\text{ V}$ $I_{DS} = 90\text{ A}$
Gate-to-Source Charge	Q_{GS}		3.5		nC	
Gate threshold charge	$Q_{G(th)}$		1.9		nC	
Gate switching charge	$Q_{G(sw)}$		3.3		nC	
Gate-to-Drain Charge	Q_{GD}		1.7		nC	
Output Charge	Q_{OSS}		20		nC	$V_{GS} = 0\text{ V}$, $V_{DS} = 50\text{ V}$
Reverse Recovery Charge	Q_{RR}		0		nC	

(4) $C_{O(ER)}$ is the fixed capacitance that would give the same stored energy as C_{OSS} while V_{DS} is rising from 0 V to the stated V_{DS}

(5) $C_{O(TR)}$ is the fixed capacitance that would give the same charging time as C_{OSS} while V_{DS} is rising from 0 V to the stated V_{DS} .

Electrical Characteristics cont'd (Typical values at $T_J = 25\text{ }^\circ\text{C}$, $V_{GS} = 6\text{ V}$ unless otherwise noted)

Parameters	Sym.	Min.	Typ.	Max.	Units	Conditions
Output Capacitance Stored Energy	E_{OSS}		0.4		μJ	$V_{DS} = 50\text{ V}$ $V_{GS} = 0\text{ V}$ $f = 100\text{ kHz}$
Switching Energy during turn-on	E_{on}		2.8		μJ	$V_{DS} = 50\text{ V}$, $I_{DS} = 20\text{ A}$ $V_{GS} = -3 - 6\text{ V}$, $R_{G(on)} = 4.7\ \Omega$, $R_{G(off)} = 1\ \Omega$
Switching Energy during turn-off	E_{off}		1.6		μJ	$L = 28\ \mu\text{H}$ $L_P = 3.8\text{ nH}$ (Notes 6, 7)

(6) L_P is the switching circuit parasitic inductance.

(7) See Figure 16 for switching loss test circuit.

Electrical Performance Graphs

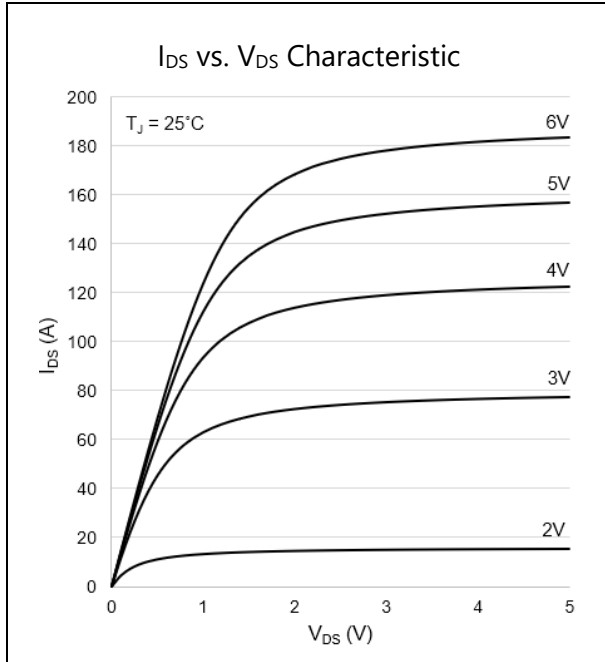

Figure 1: Typical I_{DS} vs. V_{DS} @ $T_J = 25\text{ }^\circ\text{C}$

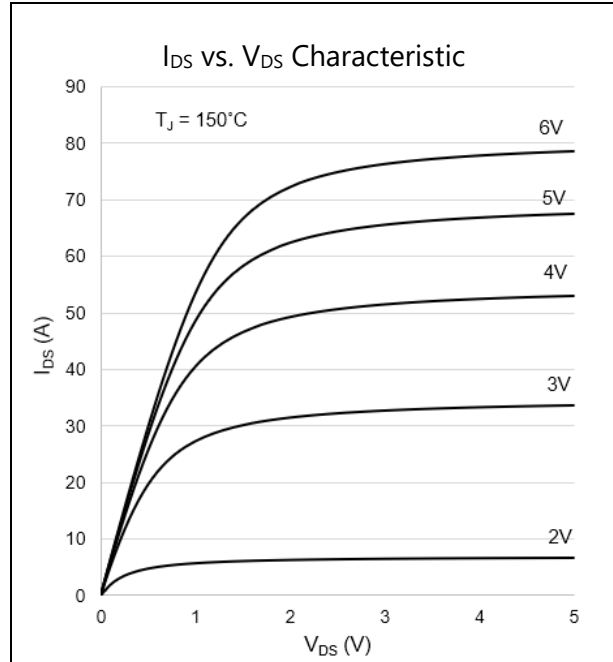

Figure 2: Typical I_{DS} vs. V_{DS} @ $T_J = 150\text{ }^\circ\text{C}$

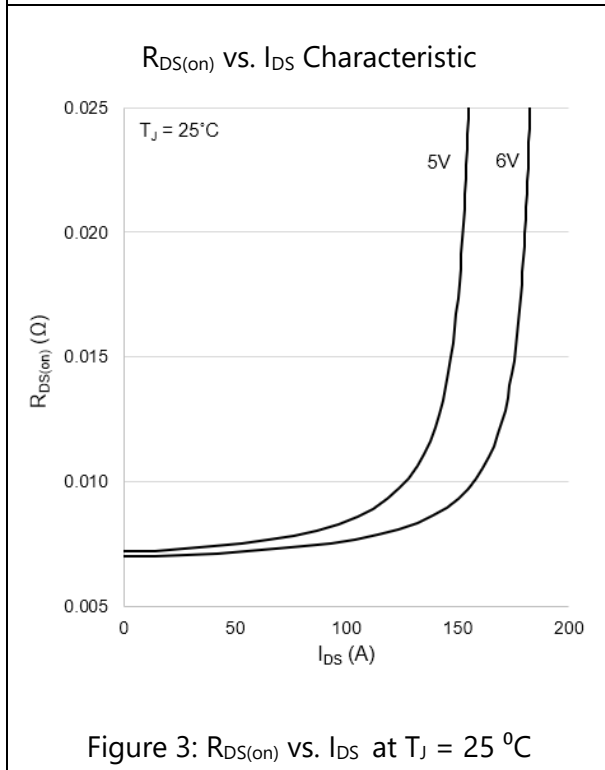

Figure 3: $R_{DS(on)}$ vs. I_{DS} at $T_J = 25\text{ }^\circ\text{C}$

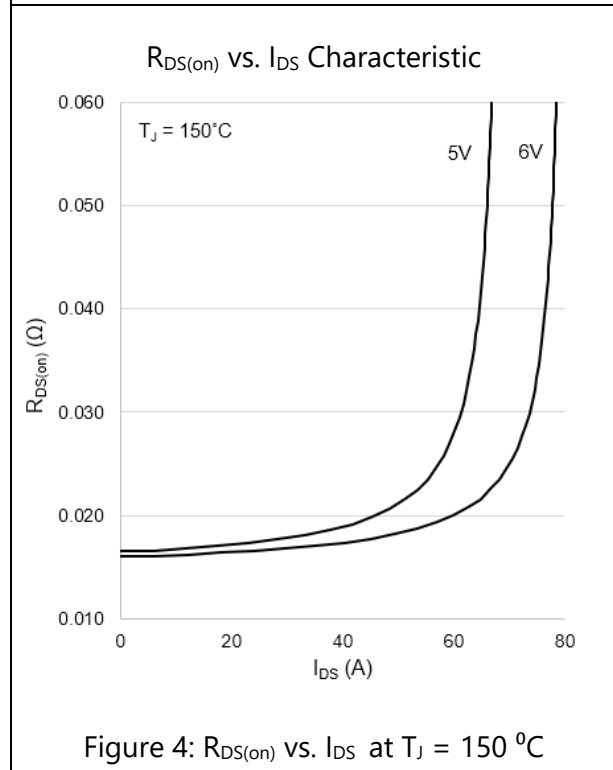
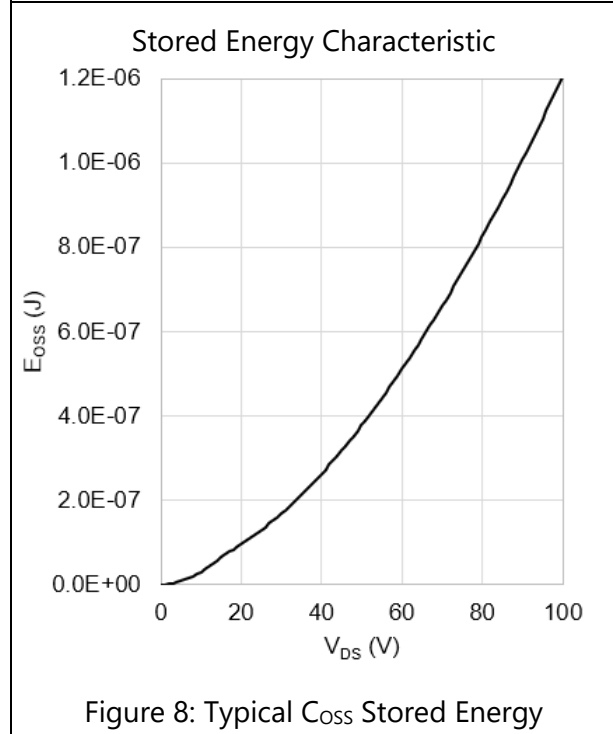
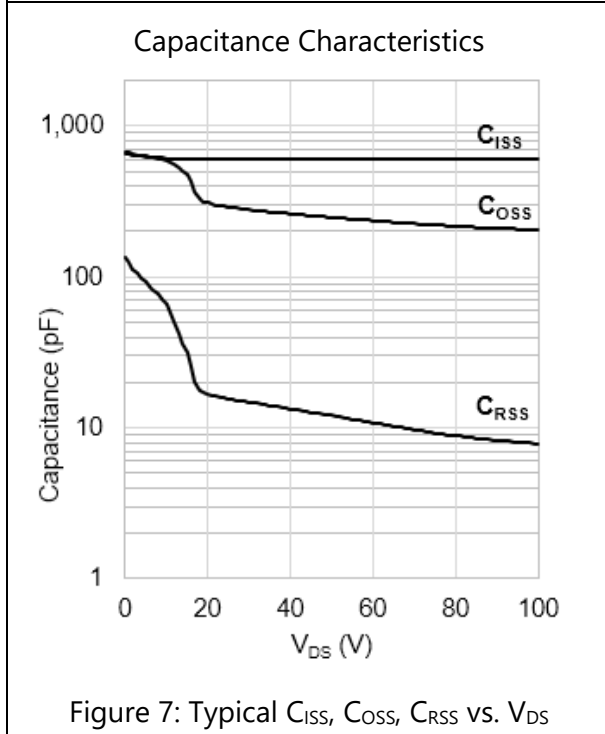
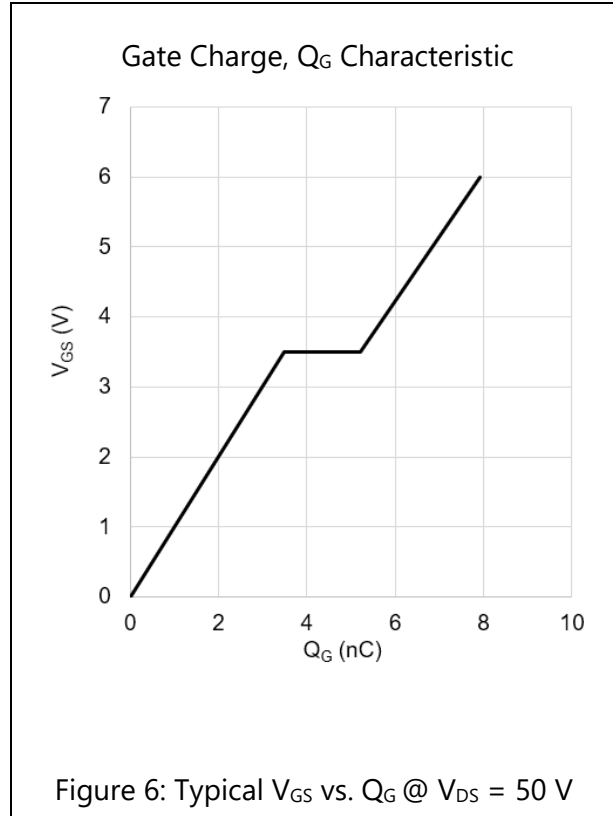
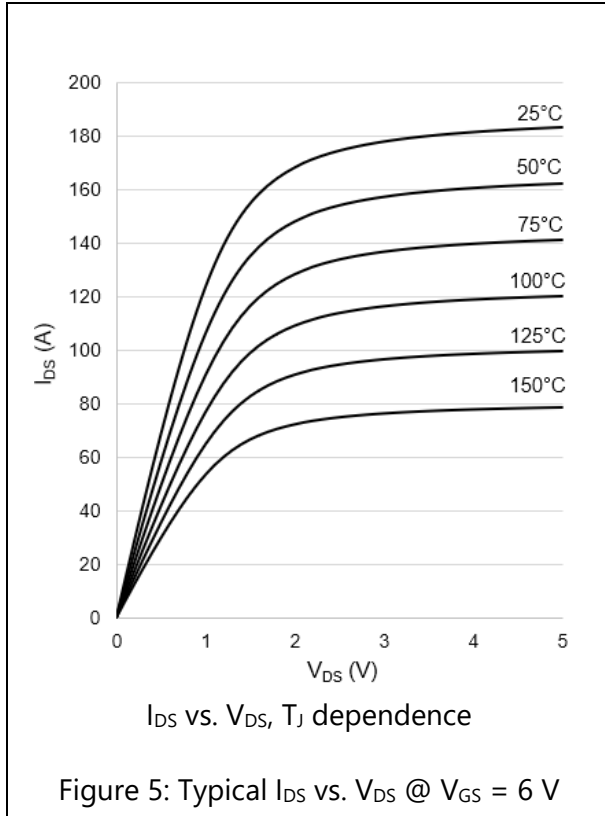

Figure 4: $R_{DS(on)}$ vs. I_{DS} at $T_J = 150\text{ }^\circ\text{C}$

Electrical Performance Graphs



Electrical Performance Graphs

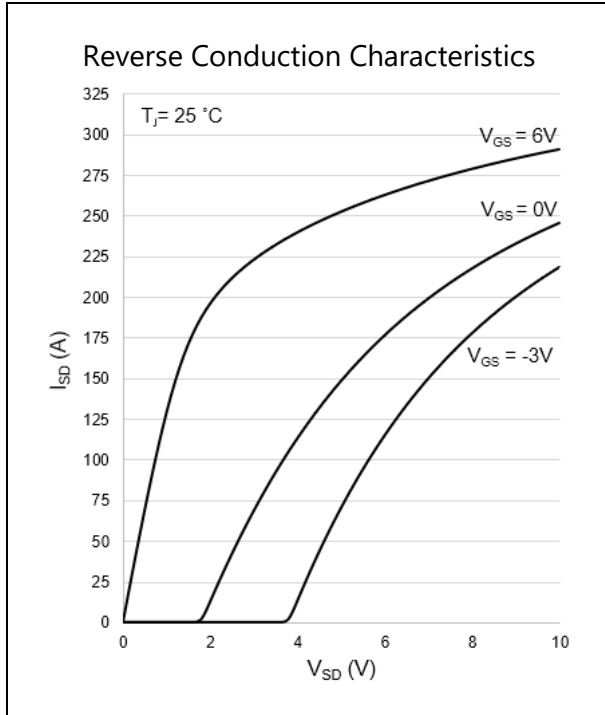

Figure 9: Typical I_{SD} vs. V_{SD} at $T_J = 25\text{ }^\circ\text{C}$

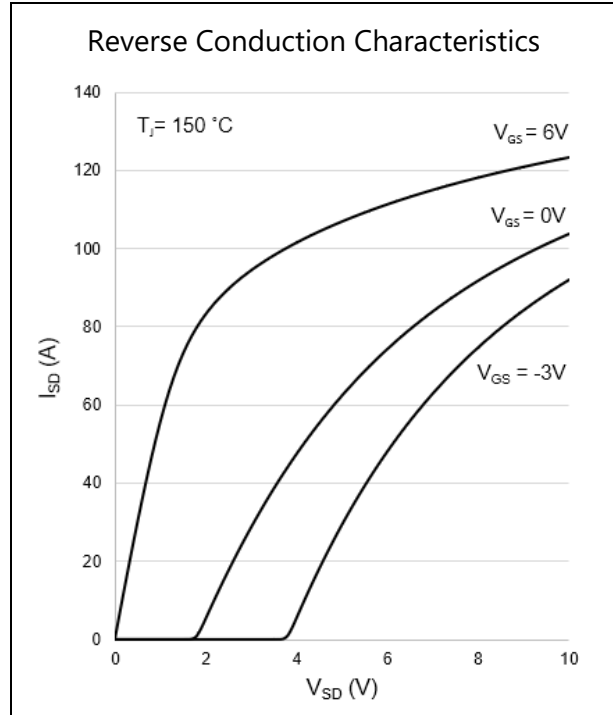

Figure 10: Typical I_{SD} vs. V_{SD} at $T_J = 150\text{ }^\circ\text{C}$

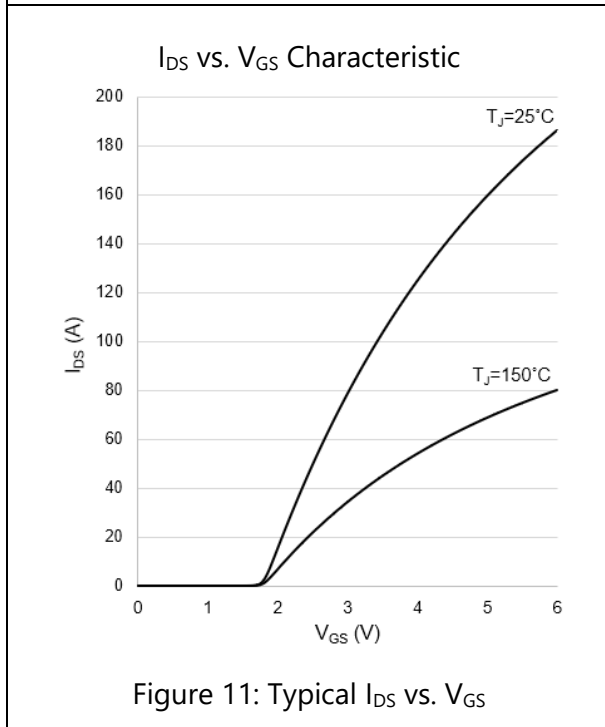

Figure 11: Typical I_{DS} vs. V_{GS}

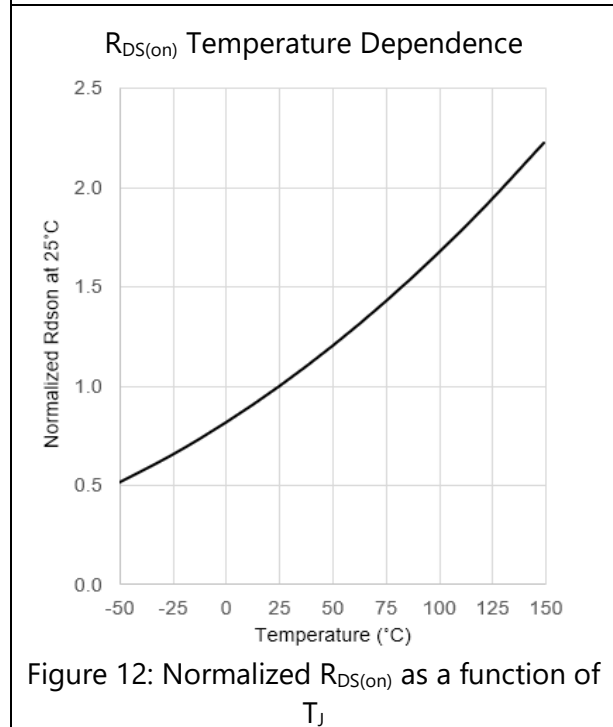

Figure 12: Normalized $R_{DS(on)}$ as a function of T_J

Thermal Performance Graphs

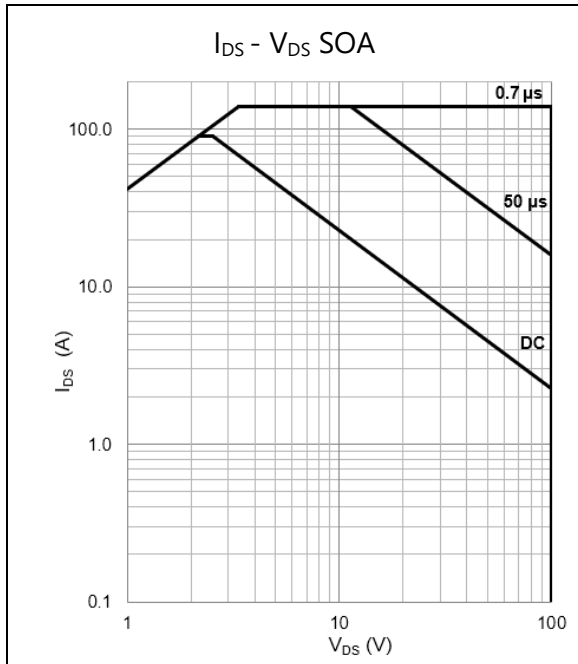

Figure 13: Safe Operating Area @ $T_{case} = 25\text{ }^{\circ}\text{C}$

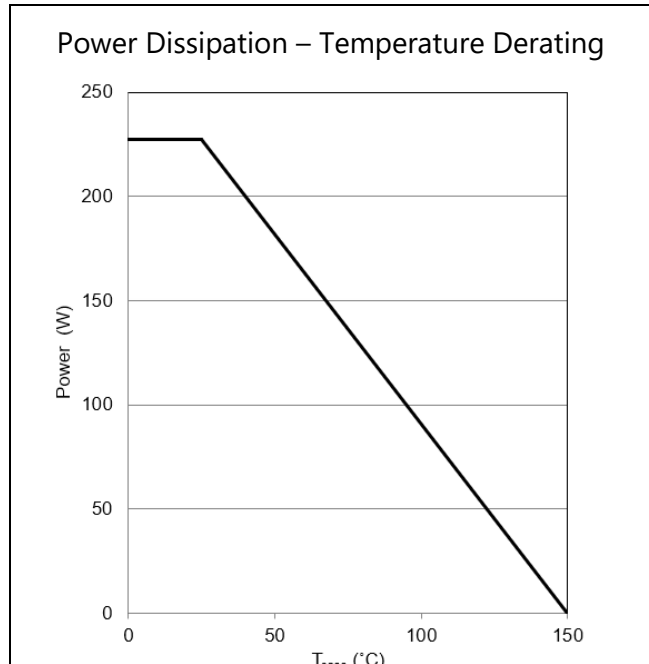

Figure 14: Power Derating vs. T_{case}

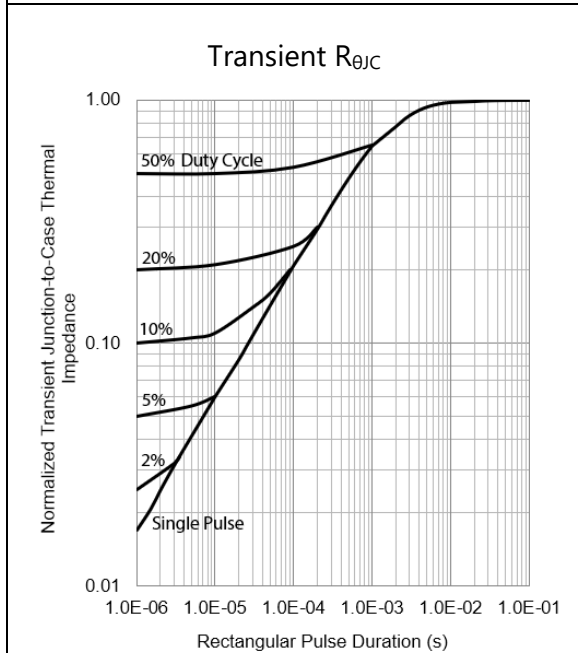

Figure 15: Transient Thermal Impedance
1.00 = Nominal DC thermal impedance

Test Circuits

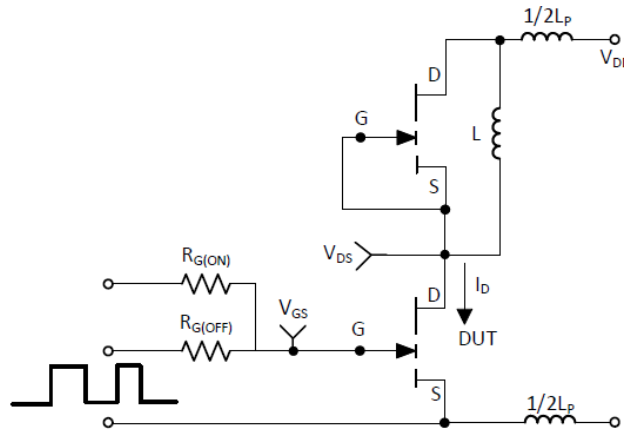

Figure 16: Switching Loss Test Circuit

Application Information

Gate Drive

The recommended gate drive voltage range, V_{GS} , is 0 V to + 6 V for optimal $R_{DS(on)}$ performance. Also, the repetitive gate to source voltage, maximum rating, $V_{GS(AC)}$, is +7 V to -10 V. The gate can survive non-repetitive transients up to +10 V and - 20 V for pulses up to 1 μ s. These specifications allow designers to easily use 6.0 V or 6.5 V gate drive settings. At 6 V gate drive voltage, the enhancement mode high electron mobility transistor (E-HEMT) is fully enhanced and reaches its optimal efficiency point. A 5 V gate drive can be used but may result in lower operating efficiency. Inherently, GaN Systems E-HEMT do not require negative gate bias to turn off. Negative gate bias, typically $V_{GS} = -3$ V, ensures safe operation against the voltage spike on the gate, however it may increase reverse conduction losses if not driven properly. For more details, please refer to the gate driver application note "GN001 How to Drive GaN Enhancement Mode Power Switching Transistors" at www.gansystems.com

Similar to a silicon MOSFET, the external gate resistor can be used to control the switching speed and slew rate. Adjusting the resistor to achieve the desired slew rate may be needed. Lower turn-off gate resistance, $R_{G(OFF)}$ is recommended for better immunity to cross conduction. Please see the gate driver application note (GN001) for more details.

A standard MOSFET driver can be used as long as it supports 6V for gate drive and the UVLO is suitable for 6V operation. Gate drivers with low impedance and high peak current are recommended for fast switching speed. GaN Systems E-HEMTs have significantly lower Q_G when compared to equally sized $R_{DS(on)}$ MOSFETs, so high speed can be reached with smaller and lower cost gate drivers.

Many non-isolated half bridge MOSFET drivers are not compatible with 6 V gate drive for GaN enhancement mode HEMT due to their high under-voltage lockout threshold. Also, a simple bootstrap method for high side gate drive will not be able to provide tight tolerance on the gate voltage. Therefore, special care should be taken when you select and use the half bridge drivers. Alternatively, isolated drivers can be used for a high side device. Please see the gate driver application note (GN001) for more details.

Parallel Operation

Design wide tracks or polygons on the PCB to distribute the gate drive signals to multiple devices. Keep the drive loop length to each device as short and equal length as possible.

GaN enhancement mode HEMTs have a positive temperature coefficient on-state resistance which helps to balance the current. However, special care should be taken in the driver circuit and PCB layout since the device switches at very fast speed. It is recommended to have a symmetric PCB layout and equal gate drive loop length (star connection if possible) on all parallel devices to ensure balanced dynamic current sharing. Adding a small gate resistor (1-2 Ω) on each gate is strongly recommended to minimize the gate parasitic oscillation.

Source Sensing

The device has a dedicated source sense pin. The GaN_{px}® packaging utilizes no wire bonds so the source connection is very low inductance. The dedicated source sense pin will further enhance performance by eliminating the common source inductance if a dedicated gate drive signal kelvin connection is created. This can be achieved connecting the gate drive signal from the driver to the gate pad and returning from the source sense pad to the driver ground reference.

Thermal

The substrate is internally connected to the thermal pad on the bottom-side of the package. The source pad must be electrically connected to the thermal pad for optimal performance. The transistor is designed to be cooled using the printed circuit board. The Drain pad is not as thermally conductive as the thermal pad. However, adding more copper under this pad will improve thermal performance by reducing the package temperature.

Thermal Modeling

RC thermal models are available to support detailed thermal simulation using SPICE. The thermal models are created using the Cauer model, an RC network model that reflects the real physical property and packaging structure of our devices. This thermal model can be extended to the system level by adding extra R_{θ} and C_{θ} to simulate the Thermal Interface Material (TIM) or Heatsink.

RC thermal model:

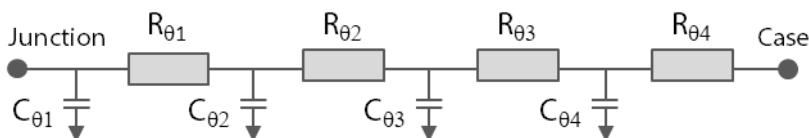

RC breakdown of $R_{\theta JC}$

R_{θ} ($^{\circ}\text{C}/\text{W}$)	C_{θ} ($\text{W}\cdot\text{s}/^{\circ}\text{C}$)
$R_{\theta 1} = 0.017$	$C_{\theta 1} = 7.0\text{E-}05$
$R_{\theta 2} = 0.253$	$C_{\theta 2} = 6.7\text{E-}04$
$R_{\theta 3} = 0.264$	$C_{\theta 3} = 5.9\text{E-}03$
$R_{\theta 4} = 0.016$	$C_{\theta 4} = 1.8\text{E-}03$

For more detail, please refer to Application Note GN007 “Modeling Thermal Behavior of GaN Systems’ GaNPX® Using RC Thermal SPICE Models” available at www.gansystems.com

Reverse Conduction

GaN Systems enhancement mode HEMTs do not need an intrinsic body diode and there is zero reverse recovery charge. The devices are naturally capable of reverse conduction and exhibit different characteristics depending on the gate voltage. Anti-parallel diodes are not required for GaN Systems transistors as is the case for IGBTs to achieve reverse conduction performance.

On-state condition ($V_{GS} = +6\text{ V}$): The reverse conduction characteristics of a GaN Systems enhancement mode HEMT in the on-state is similar to that of a silicon MOSFET, with the I-V curve symmetrical about the origin and it exhibits a channel resistance, $R_{DS(on)}$, similar to forward conduction operation.

Off-state condition ($V_{GS} \leq 0\text{ V}$): The reverse characteristics in the off-state are different from silicon MOSFETs as the GaN device has no body diode. In the reverse direction, the device starts to conduct when the gate voltage, with respect to the drain, V_{GD} , exceeds the gate threshold voltage. At this point the device exhibits a channel resistance. This condition can be modeled as a “body diode” with slightly higher V_F and no reverse recovery charge.

If negative gate voltage is used in the off-state, the source-drain voltage must be higher than $V_{GS(th)} + V_{GS(off)}$ in order to turn the device on. Therefore, a negative gate voltage will add to the reverse voltage drop “ V_F ” and hence increase the reverse conduction loss.

Blocking Voltage

The blocking voltage rating, $V_{(BL)DSS}$, is defined by the drain leakage current. The hard (unrecoverable) breakdown voltage is approximately 30 % higher than the rated $V_{(BL)DSS}$. As a general practice, the maximum drain voltage should be de-rated in a similar manner as IGBTs or silicon MOSFETs. All GaN E-HEMTs do not avalanche and thus do not have an avalanche breakdown rating. The maximum drain-to-source rating is 100 V and does not change with negative gate voltage. GaN Systems tests devices in production with a 120 V Drain-to-source voltage pulse to insure blocking voltage margin.

Packaging and Soldering

The package material is high temperature epoxy-based PCB material which is similar to FR4 but has a higher temperature rating, thus allowing the device to be specified to 150 °C. The device can handle at least 3 reflow cycles.

It is recommended to use the reflow profile in IPC/JEDEC J-STD-020 REV D.1 (March 2008)

The basic temperature profiles for Pb-free (Sn-Ag-Cu) assembly are:

- Preheat/Soak: 60 - 120 seconds. $T_{min} = 150\text{ °C}$, $T_{max} = 200\text{ °C}$.
- Reflow: Ramp up rate 3 °C/sec, max. Peak temperature is 260 °C and time within 5 °C of peak temperature is 30 seconds.
- Cool down: Ramp down rate 6 °C/sec max.

Using "No-Clean" soldering paste and operating at high temperatures may cause a reactivation of the "Non-Clean" flux residues. In extreme conditions, unwanted conduction paths may be created. Therefore, when the product operates at greater than 100 °C it is recommended to also clean the "No-Clean" paste residues.

Recommended PCB Footprint

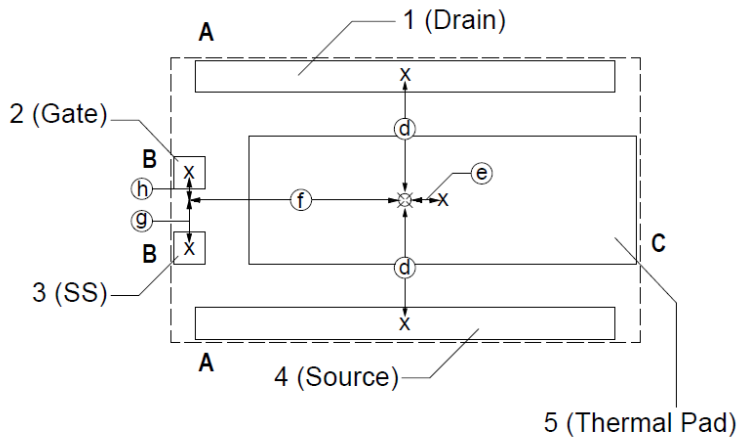



NOTE: Thermal pad (Pad 5) must be connected to Source (Pad 4)

Pad sizes

	mm		Inches	
	X (width)	Y (height)	X (width)	Y (height)
A	6.70	0.50	0.264	0.020
B	0.50	0.50	0.020	0.020
C	6.20	2.04	0.244	0.080

Dimensions

	mm	Inches
d	1.97	0.078
e	0.60	0.024
f	3.45	0.136
g	0.77	0.030
h	0.43	0.017

-  PCB pad openings
-  Package outline

Package Dimensions

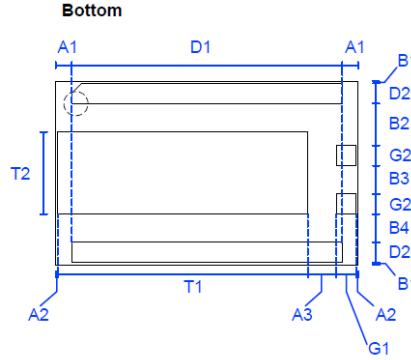
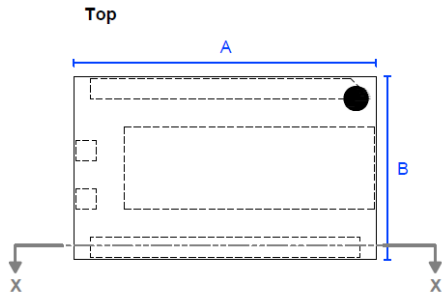

Section X-X

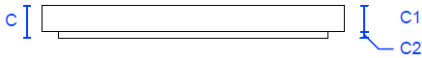

Surface Finish: ENIG
Ni: 4.5 μm +/- 1.5 μm
Au: 0.09 μm +/- 0.03 μm

mm Inches*		
A	7.55 0.297	+/- 0.100 mm (0.004")
A1	0.43 0.017	+/- 0.050 mm (0.002")
A2	0.08 0.003	+/- 0.050 mm (0.002")
A3	0.70 0.028	
B	4.59 0.181	
B1	0.08 0.003	+/- 0.100 mm (0.004")
B2	1.04 0.041	+/- 0.050 mm (0.002")
B3	0.70 0.028	
B4	0.70 0.028	
C	0.51 0.020	+/- 0.077 mm (0.003")
C1	0.50 0.020	
C2	0.01 0.0004	
D1	6.70 0.264	
D2	0.50 0.020	
G1	0.50 0.020	
G2	0.50 0.020	
T1	6.20 0.244	
T2	2.04 0.080	

*Inch measurements are approximate values

Part Marking

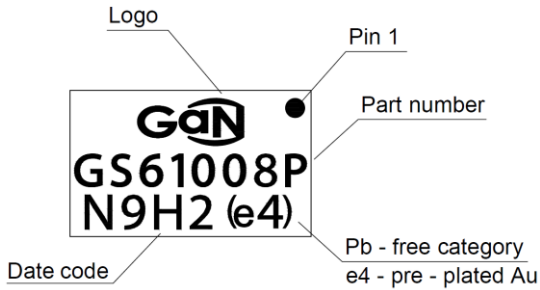

Tape and Reel Information

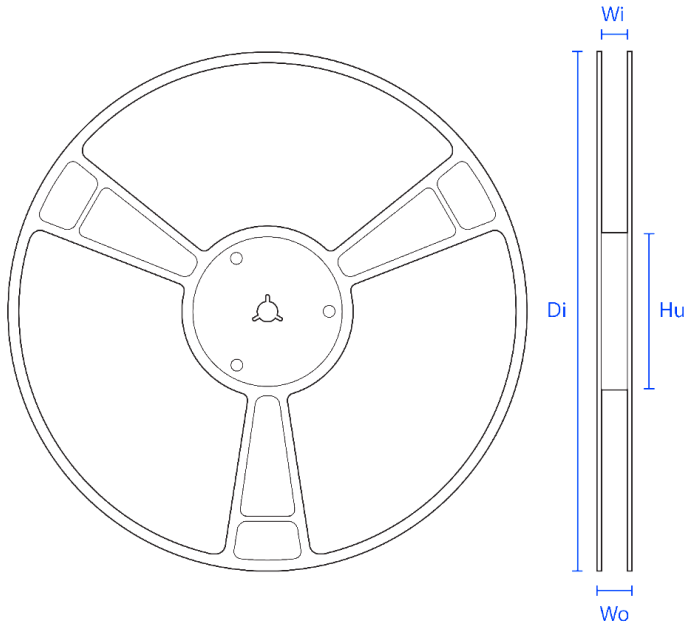

Dimensions (mm)				
	13 inch reel		7 inch reel	
	Min	Max	Min	Max
Di	328.0	332.0	Di	178.0 181.5
Wo		22.4	Wo	22.4
Wi	16.4	18.4	Wi	16.3 18.4
Hu	98.5	104.0	Hu	60.0 62.0
Hh	16.4	17.4	Hh	16.2 17.8
Sw	1.5	2.5	Sw	1.5 2.5
Hd	12.8	13.5	Hd	12.8 13.4

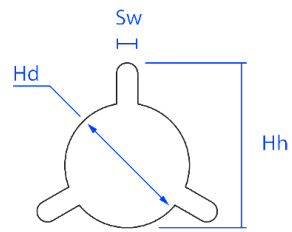

Note: Wo and Wi measured at hub

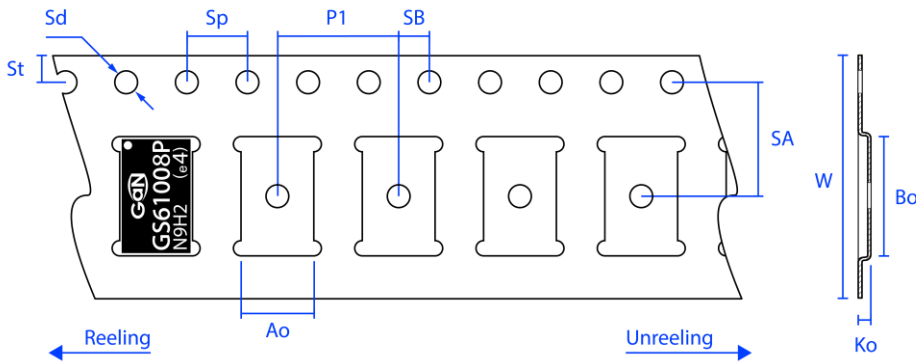

Dimensions (mm)		
	Nominal	Tolerance
P1	8.00	+/- 0.1
W	16.00	+0.3/- 0.1
Ko	1.20	+/- 0.1
Ao	4.80	+/- 0.1
Bo	7.85	+/- 0.1
Sp	4.00	+/- 0.02
Sd	1.50	+0.1/- 0.0
St	1.75	+/- 0.1
SA	7.50	+/- 0.1
SB	2.00	+/- 0.1

Tape and Reel Box Dimensions

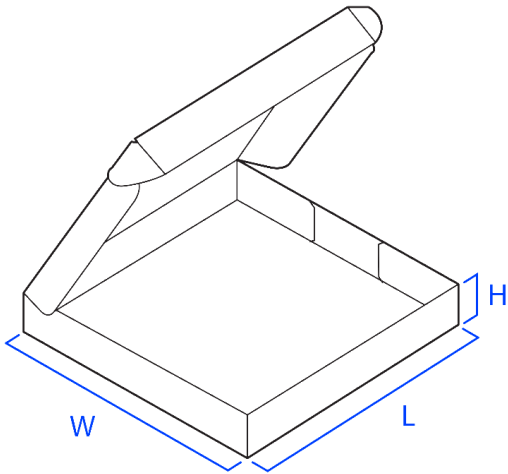

Outside dimensions (mm)

	13 inch reel		7 inch reel	
	Min	Max	Min	Max
W	197.0	203.5	W	337.0 342.0
L	204.0	218.5	L	355.0
H		32.0	H	50.0 53.0

www.gansystems.com

Important Notice – Unless expressly approved in writing by an authorized representative of GaN Systems, GaN Systems components are not designed, authorized or warranted for use in lifesaving, life sustaining, military, aircraft, or space applications, nor in products or systems where failure or malfunction may result in personal injury, death, or property or environmental damage. The information given in this document shall not in any event be regarded as a guarantee of performance. GaN Systems hereby disclaims any or all warranties and liabilities of any kind, including but not limited to warranties of non-infringement of intellectual property rights. All other brand and product names are trademarks or registered trademarks of their respective owners. Information provided herein is intended as a guide only and is subject to change without notice. The information contained herein or any use of such information does not grant, explicitly, or implicitly, to any party any patent rights, licenses, or any other intellectual property rights. GaN Systems standard terms and conditions apply. All rights reserved.