

Final datasheet

CoolSiC™ Schottky diode 2000 V G5

Features

- $V_{RRM} = 2000\text{ V}$
- $I_F = 10\text{ A}$
- $V_F = 1.5\text{ V}$
- No reverse recovery current / no forward recovery
- High surge current capability
- Temperature independent switching behavior
- Low forward voltage even at high operating temperature
- Tight forward voltage distribution
- Specified dv/dt ruggedness
- .XT interconnection technology for best-in-class thermal performance

Potential applications

- String 3-phase inverter
- EV Charging

Product validation

- Qualified for industrial applications according to the relevant tests of JEDEC47/20/22



Description

Pin definition:

Pin 1 – Cathode

Pin 2 – Anode

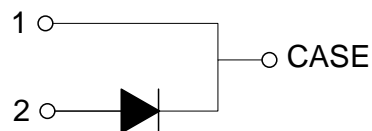

Type	Package	Marking
IDWD10G200C5	PG-TO247-2-U01	D1020C5

Table of contents

	Description	1
	Features	1
	Potential applications	1
	Product validation	1
	Table of contents	2
1	Package	3
2	SiC Diode	3
3	Characteristics diagrams	5
4	Package outlines	8
	Revision history	9
	Disclaimer	10

1 Package

Table 1 Characteristic values

Parameter	Symbol	Note or test condition	Values			Unit
			Min.	Typ.	Max.	
Storage temperature	T_{stg}		-55		150	°C
Soldering temperature	T_{sold}	wave soldering 1.6 mm (0.063 in.) from case for 10 s			260	°C
Mounting torque	M	M3 screw, Maximum of mounting processes: 3			0.6	Nm
Thermal resistance, junction-ambient	$R_{th(j-a)}$				62	K/W
Diode thermal resistance, junction-case	$R_{th(j-c)}$			0.47	0.61	K/W

2 SiC Diode

Table 2 Maximum rated values

Parameter	Symbol	Note or test condition		Values	Unit
Repetitive peak reverse voltage	V_{RRM}	$T_{vj} \geq 25\text{ °C}$		2000	V
Continuous forward current for $R_{th(j-c,max)}$	I_F	$D = 1$	$T_c = 25\text{ °C}$	35	A
			$T_c = 135\text{ °C}$	17	
			$T_c = 159\text{ °C}$	10	
Surge repetitive forward current, sine halfwave ¹⁾	$I_{F,RM}$	$t_p = 10\text{ ms}$	$T_c = 25\text{ °C}$	40	A
			$T_c = 100\text{ °C}$	30	
Surge non-repetitive forward current, sine halfwave	$I_{F,SM}$	$t_p = 10\text{ ms}$	$T_c = 25\text{ °C}$	97	A
			$T_c = 150\text{ °C}$	93	
Non-repetitive peak forward current	$I_{F,max}$	$T_c = 25\text{ °C}, t_p = 10\text{ }\mu\text{s}$		650	A
I^2t value	$\int I^2t$	$t_p = 10\text{ ms}$	$T_c = 25\text{ °C}$	47	A^2s
			$T_c = 150\text{ °C}$	43	
Diode dv/dt ruggedness	dv/dt	$V_R = 0...1500\text{ V}$		100	V/ns
Power dissipation for $R_{th(j-c,max)}$	P_{tot}	$T_c = 25\text{ °C}$		245	W

1) Not subject to production test. The test was performed with 20k pulses (half-wave rectified sine with 10 ms period).

Table 3 Characteristic values

Parameter	Symbol	Note or test condition		Values			Unit
				Min.	Typ.	Max.	
DC blocking voltage	V_{DC}	$T_{vj} = 25\text{ °C}$		2000			V
Diode forward voltage	V_F	$I_F = 10\text{ A}$	$T_{vj} = 25\text{ °C}$		1.5	1.75	V
			$T_{vj} = 150\text{ °C}$		2.3		
Reverse current	I_R	$V_R = 2000\text{ V}$	$T_{vj} = 25\text{ °C}$		5	150	μA
			$T_{vj} = 150\text{ °C}$		36		
Total capacitive charge	Q_C	$V_R = 1500\text{ V}, T_{vj} = 25\text{ °C} \& 150\text{ °C},$ $Q_C = \int_0^{V_R} C(V)dV$			89		nC
Total capacitance	C	$f = 100\text{ kHz}$	$V_R = 1\text{ V}$		1140		pF
			$V_R = 600\text{ V}$		45		
			$V_R = 1500\text{ V}$		31		
Operating junction temperature	T_{vj}			-55		175	°C

Note: For optimum lifetime and reliability, Infineon recommends operating conditions that do not exceed 80% of the maximum ratings stated in this datasheet.

Electrical Characteristic at $T_{vj} = 25\text{ °C}$, unless otherwise specified.

3 Characteristics diagrams

Power dissipation as function of case temperature

$P_{tot} = f(T_c)$
 $T_{vj} \leq 175\text{ °C}$

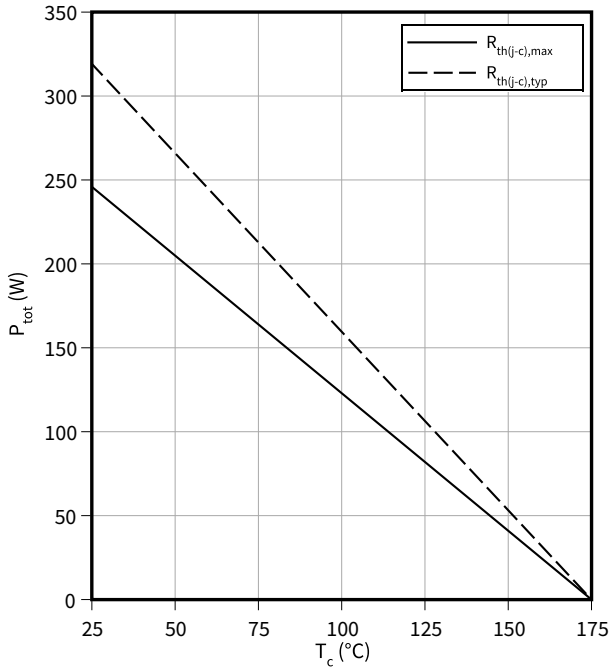

Typical forward characteristics

$I_F = f(V_F)$
 $t_p = 50\ \mu\text{s}$

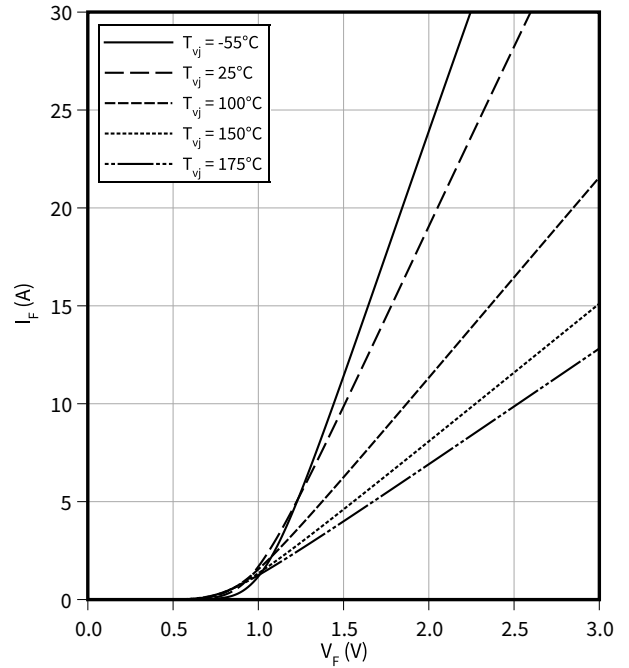

Typical forward characteristics in surge current

$I_F = f(V_F)$
 $t_p = 50\ \mu\text{s}$

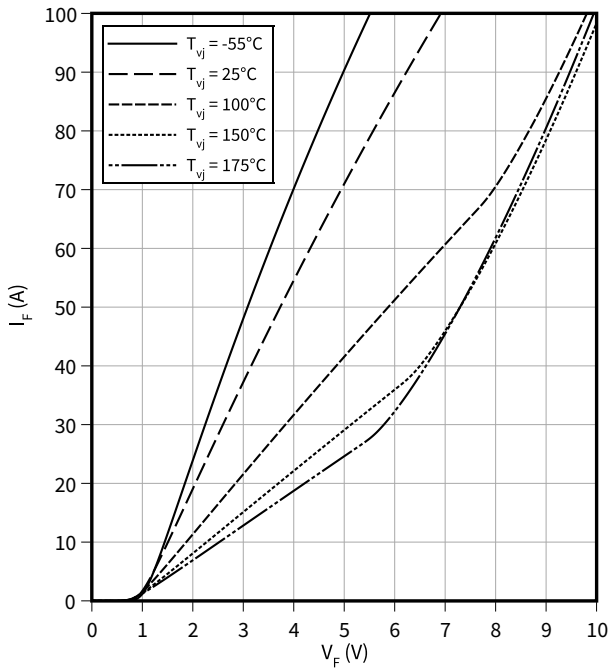

Diode forward current as function of case temperature

$I_F = f(T_c)$
 $D = \text{duty cycle}, T_{vj} \leq 175\text{ °C}$

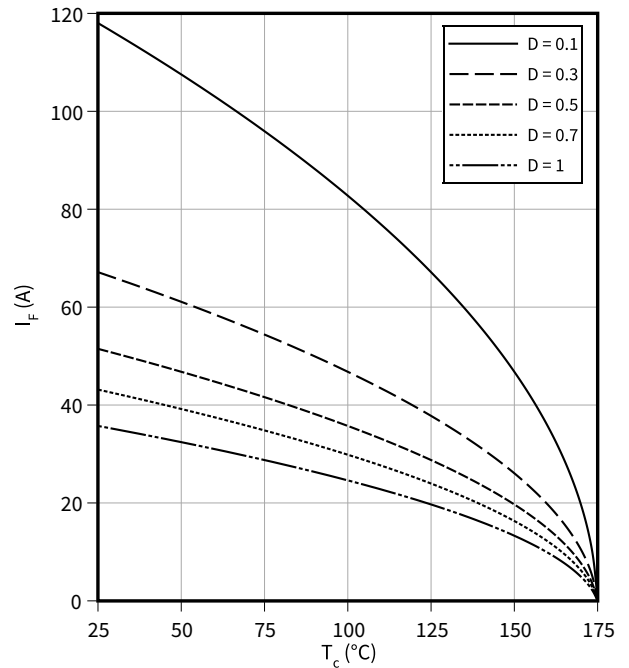

3 Characteristics diagrams

Typical capacitive charge as function of current slope

$Q_C = f(di_F/dt)$
 $T_{vj} = 25\text{ °C}, V_R = 1500\text{ V}$
 guaranteed by design

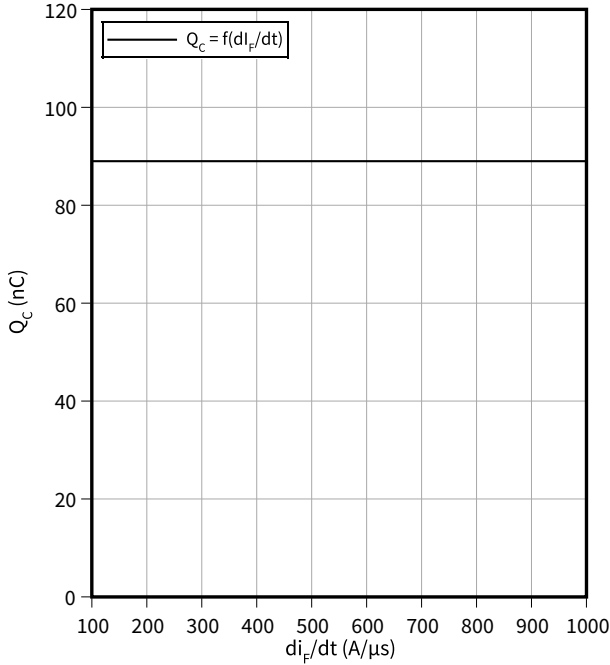

Typical reverse characteristics

$I_R = f(V_R)$

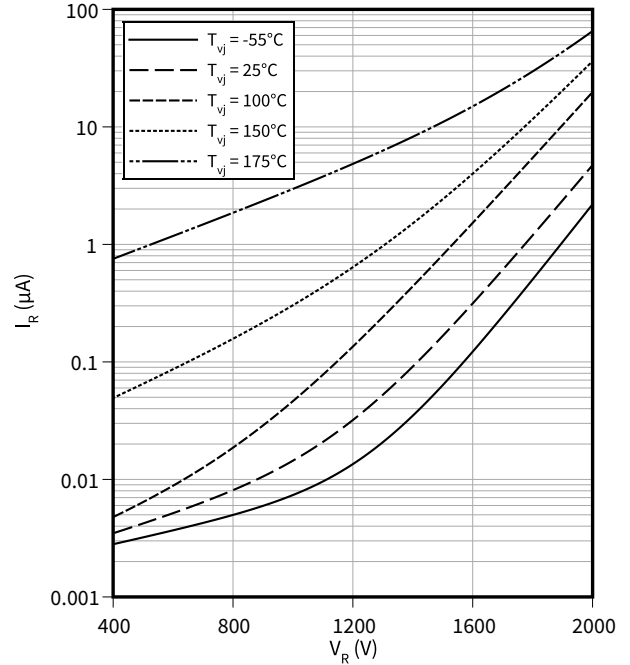

Typical capacitance as function of reverse voltage

$C = f(V_R)$
 $T_{vj} = 25\text{ °C}, f = 100\text{ kHz}$

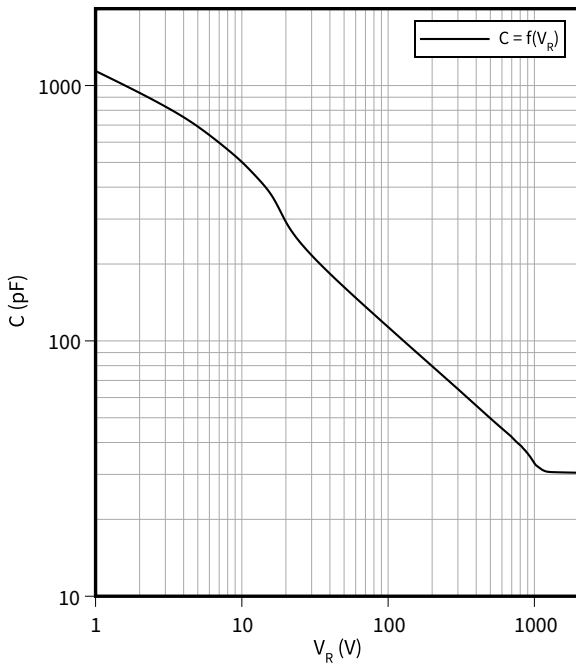

Typical capacitively stored energy as function of reverse voltage

$E_C = f(V_R)$
 $f = 100\text{ kHz}$

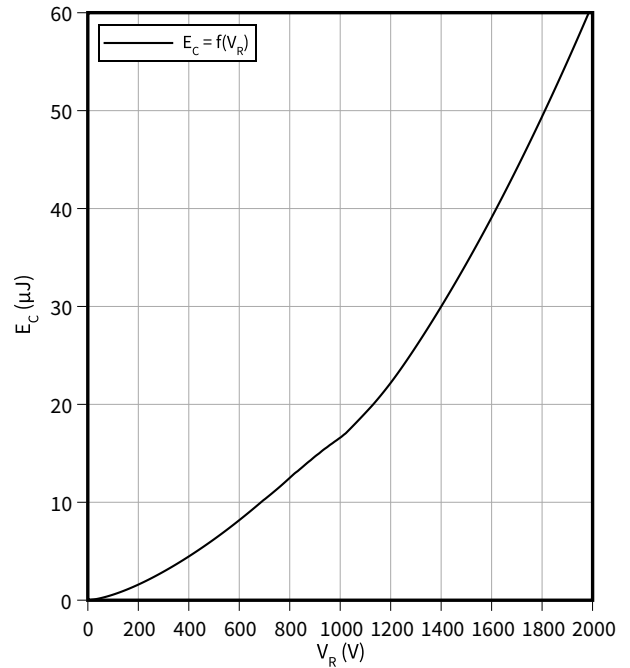

3 Characteristics diagrams

Max. transient thermal impedance

$$Z_{th(j-c),max} = f(t_p)$$

$$D = t_p/T$$

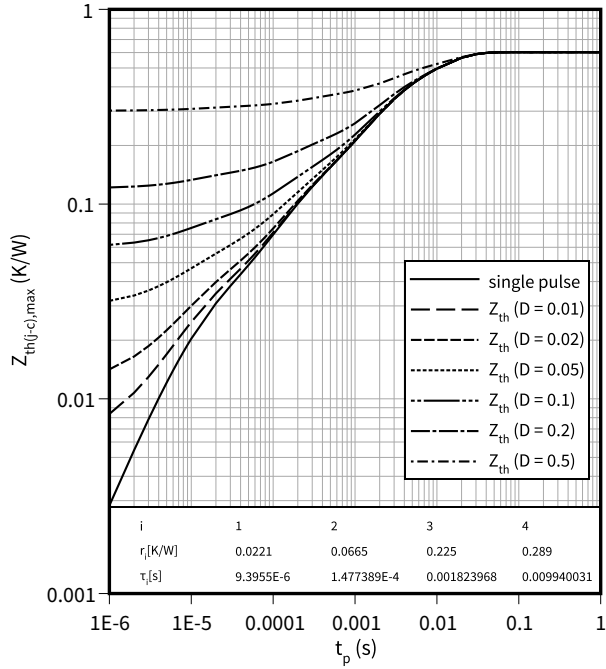

4 Package outlines

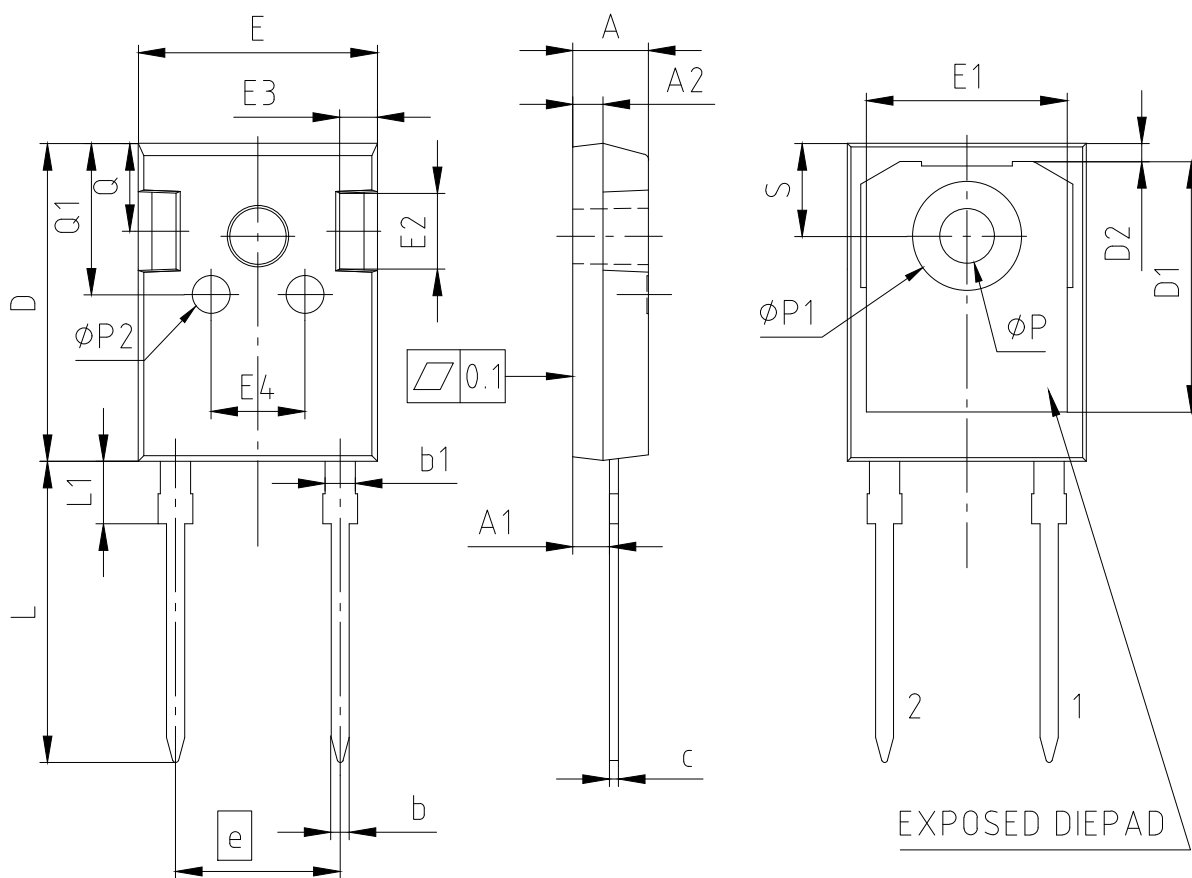

PACKAGE - GROUP NUMBER:		PG-TO247-2-U01			
DIMENSIONS	MILLIMETERS				
	MIN.	MAX.			
A	4.90	5.10	L	19.80	20.10
A1	2.31	2.51	L1	---	4.30
A2	1.90	2.10	ϕP	3.50	3.70
b	1.16	1.26	$\phi P1$	7.00	7.40
b1	1.96	2.06	$\phi P2$	2.40	2.60
c	0.59	0.66	Q	5.60	6.00
D	20.90	21.10	Q1	9.80	10.20
D1	16.25	16.85	S	6.05	6.25
D2	1.05	1.35			
E	15.70	15.90			
E1	13.10	13.50			
E2	4.90	5.10			
E3	2.40	2.60			
E4	6.00	6.40			
e	10.88				
N	2				

ALL DIMENSIONS DO NOT INCLUDE
MOLD FLASH OR PROTRUSIONS.

Figure 1

Revision history

Document revision	Date of release	Description of changes
0.10	2023-05-16	Target datasheet
0.20	2024-03-21	Preliminary datasheet
1.00	2024-08-21	Final datasheet
1.10	2024-10-07	Editorial changes

Trademarks

All referenced product or service names and trademarks are the property of their respective owners.

Edition 2024-10-07

Published by

Infineon Technologies AG

81726 Munich, Germany

© 2024 Infineon Technologies AG

All Rights Reserved.

Do you have a question about any aspect of this document?

Email: erratum@infineon.com

Document reference

IFX-ABH258-004

Important notice

The information given in this document shall in no event be regarded as a guarantee of conditions or characteristics ("Beschaffheitsgarantie").

With respect to any examples, hints or any typical values stated herein and/or any information regarding the application of the product, Infineon Technologies hereby disclaims any and all warranties and liabilities of any kind, including without limitation warranties of non-infringement of intellectual property rights of any third party.

In addition, any information given in this document is subject to customer's compliance with its obligations stated in this document and any applicable legal requirements, norms and standards concerning customer's products and any use of the product of Infineon Technologies in customer's applications.

The data contained in this document is exclusively intended for technically trained staff. It is the responsibility of customer's technical departments to evaluate the suitability of the product for the intended application and the completeness of the product information given in this document with respect to such application.

Please note that this product is not qualified according to the AEC Q100 or AEC Q101 documents of the Automotive Electronics Council.

Warnings

Due to technical requirements products may contain dangerous substances. For information on the types in question please contact your nearest Infineon Technologies office.

Except as otherwise explicitly approved by Infineon Technologies in a written document signed by authorized representatives of Infineon Technologies, Infineon Technologies' products may not be used in any applications where a failure of the product or any consequences of the use thereof can reasonably be expected to result in personal injury.