

## CoolGaN™ G5

### CoolGaN™ Transistor 650 V G5

Infineon's CoolGaN™ is a highly efficient gallium nitride (GaN) transistor designed for power conversion at 650 V. It enables higher power density, supports reduced system BOM cost, and facilitates miniaturized form factors. Produced using 200 mm (8 inch) wafer technology and fully automated production lines, it features narrow production tolerances and the highest product quality. This makes it suitable for a wide range of applications, from consumer electronics to industrial applications.

### Features

- Enhancement mode transistor
- Ultra-fast switching
- No reverse-recovery charge
- Capable of reverse conduction
- Low gate and output charge
- Superior commutation ruggedness
- 2 kV HBM ESD standards

### Benefits

- Normally OFF transistor technology ensures safe operation
- Enables rapid and precise power delivery control
- Improves system efficiency and reliability
- Ensures robust performance under challenging conditions

These features collectively make CoolGaN™ a game-changer in the realm of power conversion, offering a compelling combination of efficiency, compactness, and reliability.

### Potential applications

Industrial, telecom, datacenter SMPS based on half-bridge hard and soft switching topologies such as totem pole PFC and high frequency LLC, as well as charger and adapter.

### Product validation

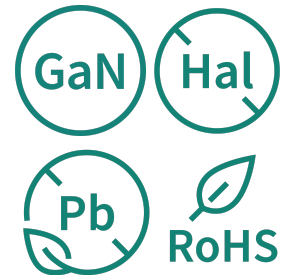
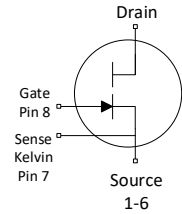
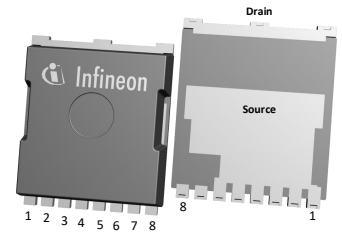
Fully qualified according to JEDEC for Industrial Applications

**Table 1** Key performance parameters

Parameter	Value	Unit
$V_{DS,max}$	650	V
$V_{DS,trans-max}$	900	V
$R_{DS(on),max}$	42	mΩ
$Q_{g,typ}$	7.7	nC
$I_{D,pulse}$	97	A
$Q_{oss @ 400 V}$	57	nC
$Q_{rr}$	0	nC

Type / Ordering code	Package	Marking	Related links
IGT65R035D2	PG-HSOF-8	65R035D2	see Appendix A

TOLL





## Table of contents

Description .....	1
Maximum ratings .....	3
Thermal characteristics .....	5
Electrical characteristics .....	6
Electrical characteristics diagrams .....	8
Test circuits .....	13
Package outlines .....	14
Appendix A .....	17
Revision history .....	18
Trademarks .....	18
Disclaimer .....	18

## 1 Maximum ratings

at  $T_j = 25^\circ\text{C}$ , unless otherwise specified. Stresses beyond max ratings may cause permanent damage to the device. For optimum lifetime and reliability, Infineon recommends operating conditions that do not continuously exceed 80% of the maximum ratings stated (unless otherwise explicitly stated). For further information, contact your local Infineon sales office.

**Table 2 Maximum ratings**

Parameter	Symbol	Values			Unit	Note / Test condition
		Min.	Typ.	Max.		
Drain source voltage, continuous	$V_{DS,max}$	-	-	650	V	$V_{GS} = 0\text{ V}$ , derating recommendation according JEDEC JEP198
Leakage current at drain source transient voltage	$I_{DS,trans}$	-	-	20	mA	$V_{GS} = 0\text{ V}$ , $V_{DS,trans} = 900\text{ V}$
Drain source voltage transient	$V_{DS,trans}$	-	-	900	V	<1% duty cycle, <1 $\mu\text{s}$ , 1 million pulses
Drain source voltage, pulsed	$V_{DS,pulsed}$	-	-	750 650	V	$T_j = 25^\circ\text{C}$ ; $V_{GS} \leq 0\text{ V}$ ; cumulated stress time $\leq 1\text{ h}$ $T_j = 125^\circ\text{C}$ ; $V_{GS} \leq 0\text{ V}$ ; cumulated stress time $\leq 1\text{ h}$
Switching surge voltage, pulsed	$V_{DS,surge}$	-	-	750	V	DC bus voltage = 700 V; turn off $V_{DS,pulse} = 750\text{ V}$ ; turn on $I_{D,pulse} = 44\text{ A}$ ; $T_j = 105^\circ\text{C}$ ; $f \leq 100\text{ kHz}$ , $t \leq 100\text{ s}$ (10 million pulses)
Continuous current, drain source <sup>1)</sup>	$I_D$	-	-	49	A	$T_C = 25^\circ\text{C}$ ; $T_j = T_{j,max}$
Pulsed current, drain source	$I_{D,pulse}$	-97 -58	-	97 58	A	$T_j = 25^\circ\text{C}$ ; $I_G = 42\text{ mA}$ ; See Diagram 3, 5 $T_j = 125^\circ\text{C}$ ; $I_G = 42\text{ mA}$ ; See Diagram 4, 6
Gate current, continuous <sup>2)</sup>	$I_{G,avg}$	-	-	32	mA	$T_j = -55^\circ\text{C}$ to $T_j = 150^\circ\text{C}$ ; See Table 9
Gate current, pulsed <sup>2)</sup>	$I_{G,pulsed}$	-3.2	-	3.2	A	$T_j = -55^\circ\text{C}$ to $T_j = 150^\circ\text{C}$ ; $t_{pulse} = 50\text{ ns}$ , $f = 100\text{ kHz}$ ; See Table 9
Gate source voltage, continuous <sup>2)</sup>	$V_{GS}$	-10	-	-	V	$T_j = -55^\circ\text{C}$ to $T_j = 150^\circ\text{C}$ ; See Diagram 12
Gate source voltage, pulsed <sup>2)</sup>	$V_{GS,pulse}$	-25	-	-	V	$T_j = -55^\circ\text{C}$ to $T_j = 150^\circ\text{C}$ ; $t_{pulse} = 50\text{ ns}$ , $f = 100\text{ kHz}$ ; open drain
Power dissipation	$P_{tot}$	-	-	167	W	$T_C = 25^\circ\text{C}$
Operating junction temperature	$T_j$	-55	-	150	$^\circ\text{C}$	-
Storage temperature	$T_{stg}$	-55	-	150	$^\circ\text{C}$	Max shelf life depends on storage conditions
Drain-source voltage slew-rate	$dv/dt$	-	-	200	V/ns	-

- 1) Limited by  $T_{j,max}$ . Maximum duty cycle  $D = 0.75$
- 2) We recommend using an advanced driving technique to optimize the device performance. Please see gate drive application note for more details.

## 2 Thermal characteristics

**Table 3 Thermal characteristics**

Parameter	Symbol	Values			Unit	Note / Test condition
		Min.	Typ.	Max.		
Thermal resistance, junction - case	$R_{thJC}$	-	-	0.76	°C/W	-
Thermal resistance, junction - ambient	$R_{thJA}$	-	-	86	°C/W	Device on PCB, minimum footprint
Thermal resistance, junction - ambient for SMD version	$R_{thJA}$	-	-	62	°C/W	Device on 40 mm*40 mm*1.5 mm epoxy PCB FR4 with 6 cm <sup>2</sup> (one layer, 70 μm thickness) copper area for tab (source) connection and cooling. PCB is vertical without air stream cooling.
Reflow soldering temperature	$T_{sold}$	-	-	260	°C	MSL1

### 3 Electrical characteristics

at  $T_j=25^\circ\text{C}$ , unless specified otherwise

**Table 4 Static characteristics**

Parameter	Symbol	Values			Unit	Note / Test condition
		Min.	Typ.	Max.		
Gate threshold voltage	$V_{GS(th)}$	0.9 -	1.2 1	1.6 -	V	$I_{DS}=4.2\text{ mA}; V_{DS}=10\text{ V}; T_j=25^\circ\text{C}$ $I_{DS}=4.2\text{ mA}; V_{DS}=10\text{ V}; T_j=150^\circ\text{C}$
Gate-Source reverse clamping voltage	$V_{GS, clamp}$	-	-	-8	V	$I_{GS}=-1\text{ mA}$
Drain-Source leakage current	$I_{DSS}$	-	1.6 32	160 -	$\mu\text{A}$	$V_{DS}=650\text{ V}, V_{GS}=0\text{ V}, T_j=25^\circ\text{C}$ $V_{DS}=650\text{ V}, V_{GS}=0\text{ V}, T_j=150^\circ\text{C}$
Drain-Source on-state resistance	$R_{DS(on)}$	-	0.035 0.075	0.042 -	$\Omega$	$I_G=42\text{ mA}; I_D=13\text{ A}; T_j=25^\circ\text{C}$ $I_G=42\text{ mA}; I_D=13\text{ A}; T_j=150^\circ\text{C}$
Gate resistance	$R_{G,int}$	-	1.4	-	$\Omega$	LCR impedance measurement; $f=f_{res}$ , open drain;

**Table 5 Dynamic characteristics**

Parameter	Symbol	Values			Unit	Note / Test condition
		Min.	Typ.	Max.		
Input capacitance	$C_{iss}$	-	540	-	pF	$V_{GS}=0\text{ V}; V_{DS}=400\text{ V}, f=1\text{ MHz}$
Output capacitance	$C_{oss}$	-	91	-	pF	$V_{GS}=0\text{ V}, V_{DS}=400\text{ V}, f=1\text{ MHz}$
Reverse transfer capacitance	$C_{rss}$	-	1.3	-	pF	
Effective output capacitance, energy related <sup>3)</sup>	$C_{o(er)}$	-	105	-	pF	$V_{DS}=0\text{ to }400\text{ V}$
Effective output capacitance, time related <sup>4)</sup>	$C_{o(tr)}$	-	142	-	pF	$V_{GS}=0\text{ V}; V_{DS}=0\text{ to }400\text{ V}; I_D=const$
Output charge	$Q_{oss}$	-	57	-	nC	$V_{DS}=0\text{ to }400\text{ V}$
Coss stored energy	$E_{oss}$	-	8.4	-	$\mu\text{J}$	
Turn-on delay time	$t_{d(on)}$	-	11	-	ns	$I_D=13\text{ A}; R_{ON}=3.3\text{ Ohm}; R_{OFF}=3.3\text{ Ohm}; R_{SS}=220\text{ Ohm}; C_C=5.3\text{ nF}; V_{DRV}=12\text{ V}; \text{ see Table 8}$
Turn-off delay time	$t_{d(off)}$	-	15	-	ns	
Rise time	$t_r$	-	10	-	ns	
Fall time	$t_f$	-	11	-	ns	

<sup>3)</sup>  $C_{o(er)}$  is a fixed capacitance that gives the same stored energy as  $C_{oss}$  while  $V_{DS}$  is rising from 0 to 400 V

<sup>4)</sup>  $C_{o(tr)}$  is a fixed capacitance that gives the same charging time as  $C_{oss}$  while  $V_{DS}$  is rising from 0 to 400 V

**Table 6 Gate charge characteristics**

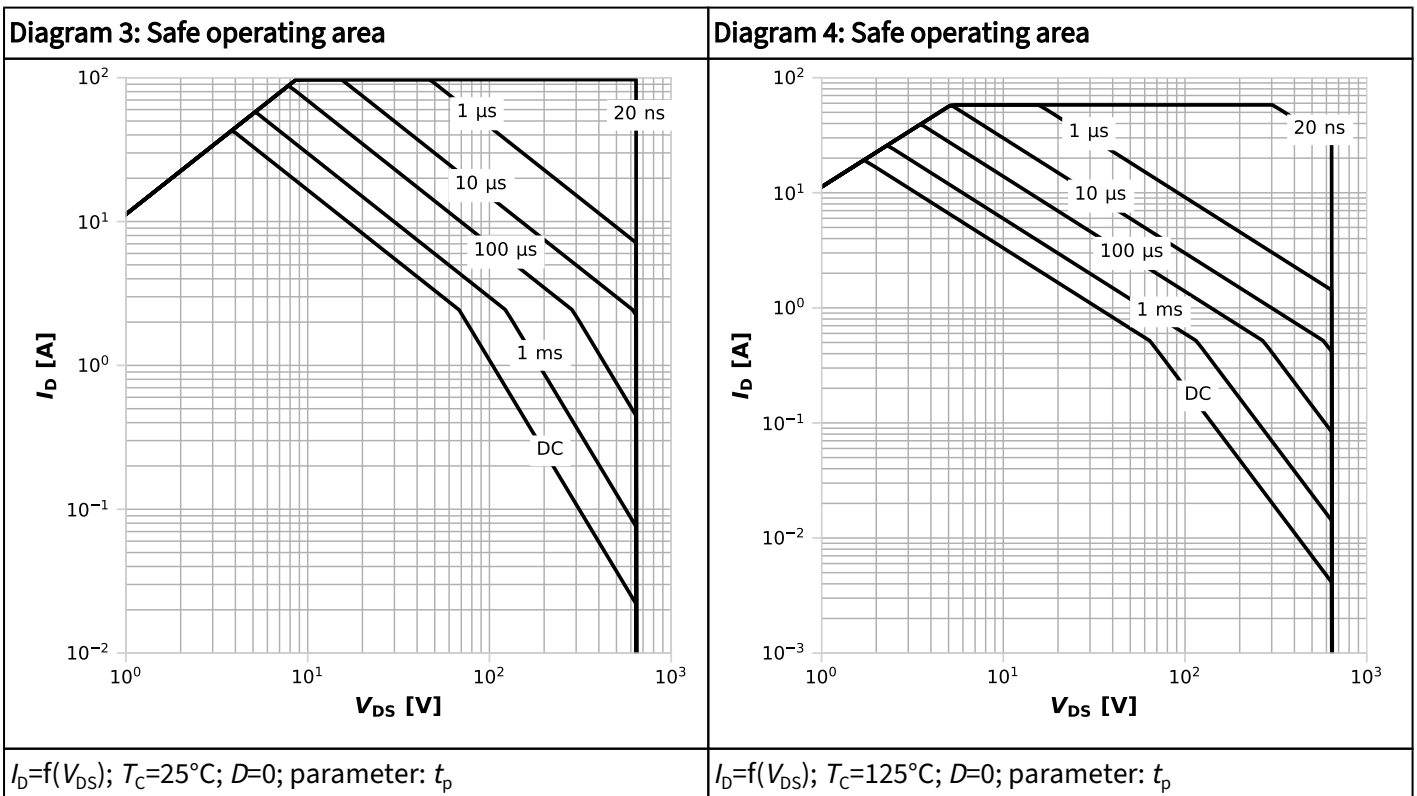
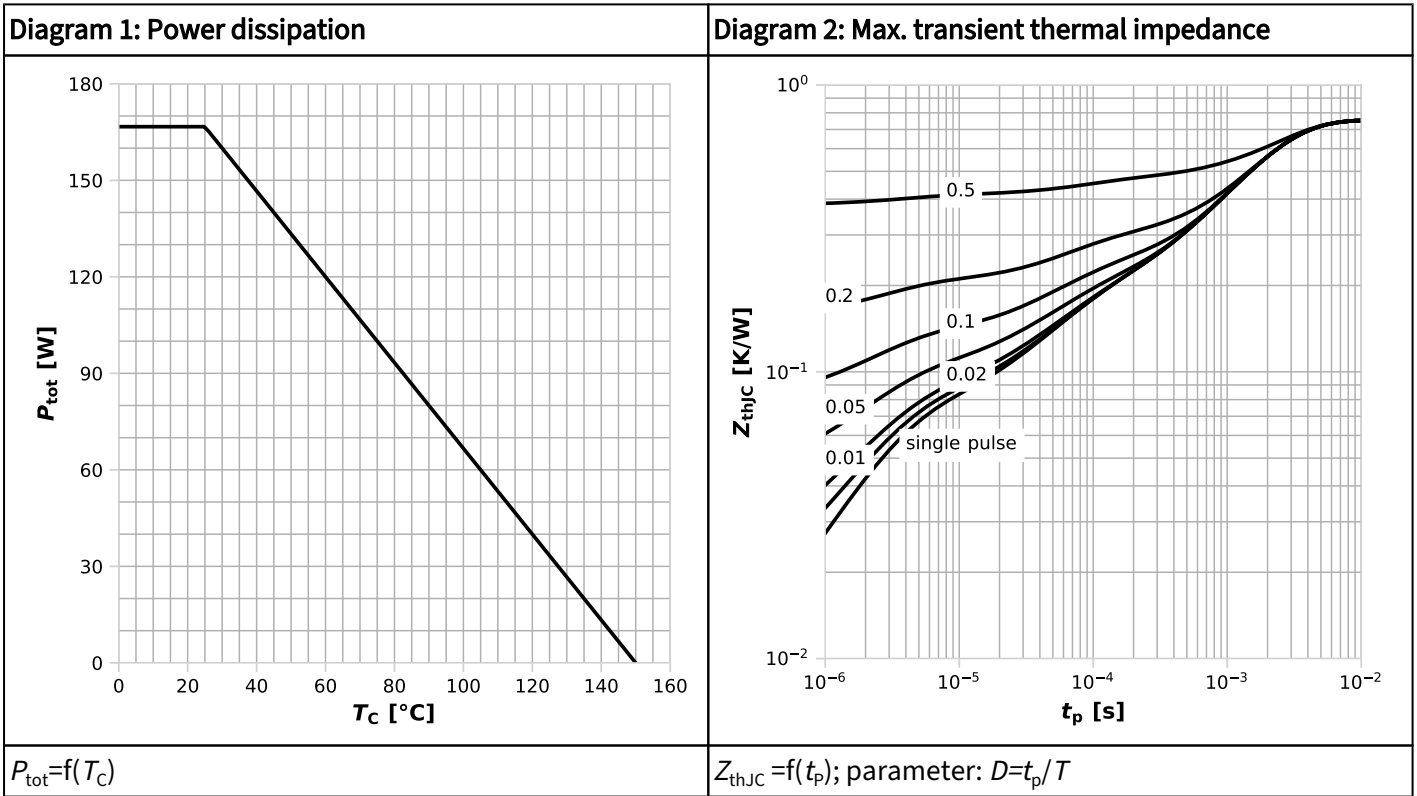
Parameter	Symbol	Values			Unit	Note / Test condition
		Min.	Typ.	Max.		
Gate charge	$Q_G$	-	7.7	-	nC	$V_{GS}=0\text{ to }3\text{ V}; V_{DS}=400\text{ V}, I_D=13\text{ A}$

**Table 7 Reverse conduction characteristics**

Parameter	Symbol	Values			Unit	Note / Test condition
		Min.	Typ.	Max.		
Source-Drain reverse voltage	$V_{SD}$	-	2.0	2.4	V	$V_{GS}=0\text{ V}; I_{SD}=13\text{ A}$
Pulsed current, reverse	$I_{SD,pulse}$	-	-	97	A	$I_G=42\text{ mA}$
Reverse recovery charge <sup>5)</sup>	$Q_{rr}$	-	0	-	nC	$I_{SD}=13\text{ A}; V_{DS}=400\text{ V}$

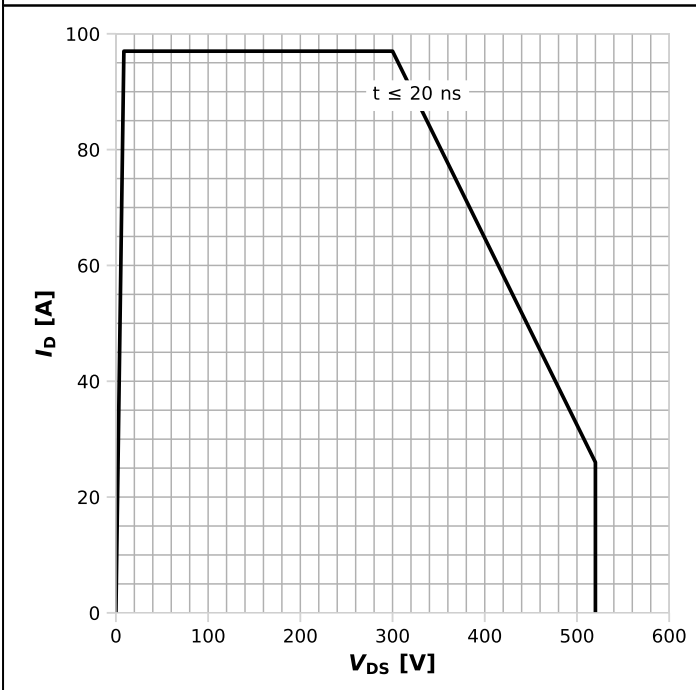
<sup>5)</sup> Excluding  $Q_{oss}$

## 4 Electrical characteristics diagrams



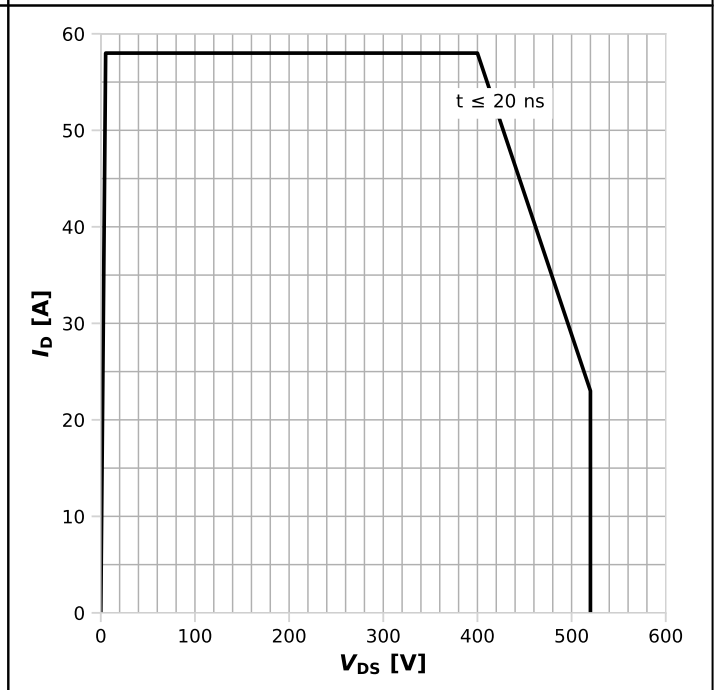


**Diagram 5: Repetitive safe operating area**



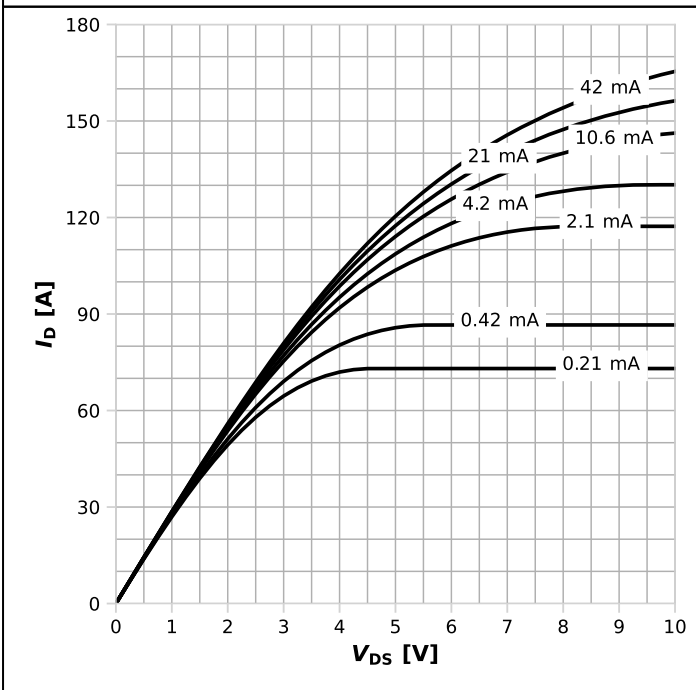
$I_D=f(V_{DS}); T_c=25^\circ\text{C}; T_j \leq 150^\circ\text{C};$  parameter:  $t_p$

**Diagram 6: Repetitive safe operating area**



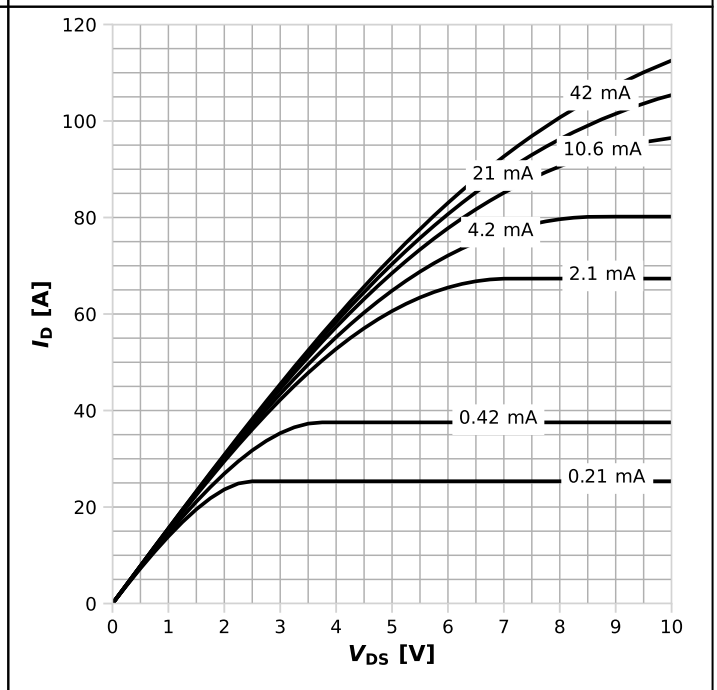
$I_D=f(V_{DS}); T_c=125^\circ\text{C}; T_j \leq 150^\circ\text{C};$  parameter:  $t_p$

**Diagram 7: Typ. output characteristics**



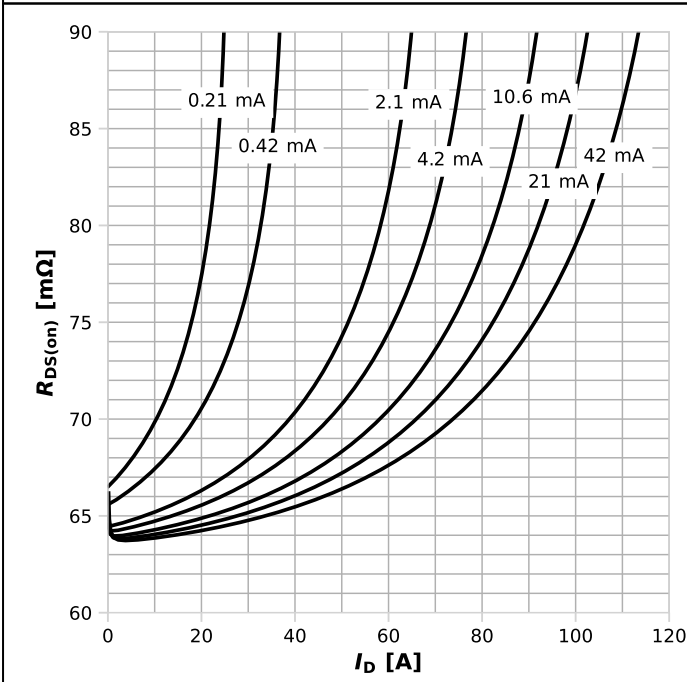
$I_D=f(V_{DS}); T_j=25^\circ\text{C};$  parameter:  $I_{GS}$

**Diagram 8: Typ. output characteristics**



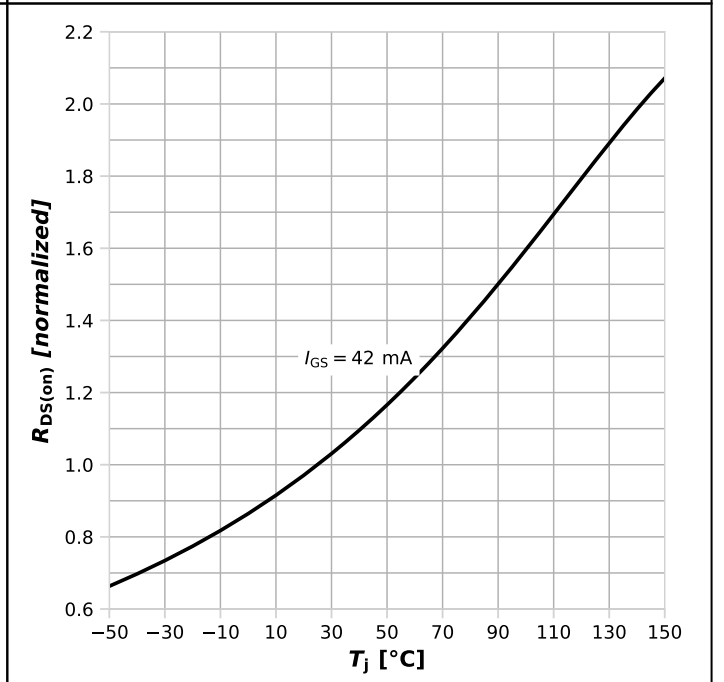
$I_D=f(V_{DS}); T_j=125^\circ\text{C};$  parameter:  $I_{GS}$

Diagram 9: Typ. Drain-source on-state resistance



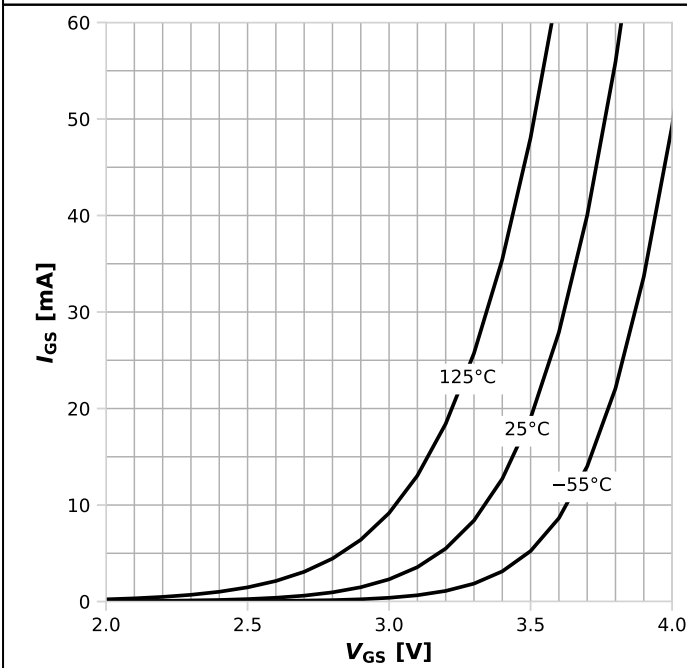
$R_{DS(on)}=f(I_D); T_j=125^\circ\text{C}; \text{parameter: } I_{GS}$

Diagram 10: Drain-source on-state resistance



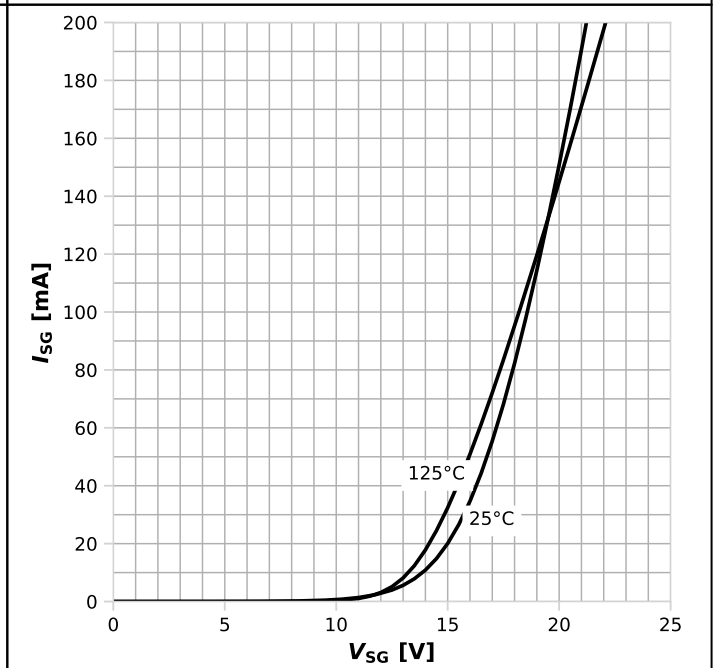
$R_{DS(on)}=f(T_j); I_D=13 \text{ A}$

Diagram 11: Typ. gate characteristics forward



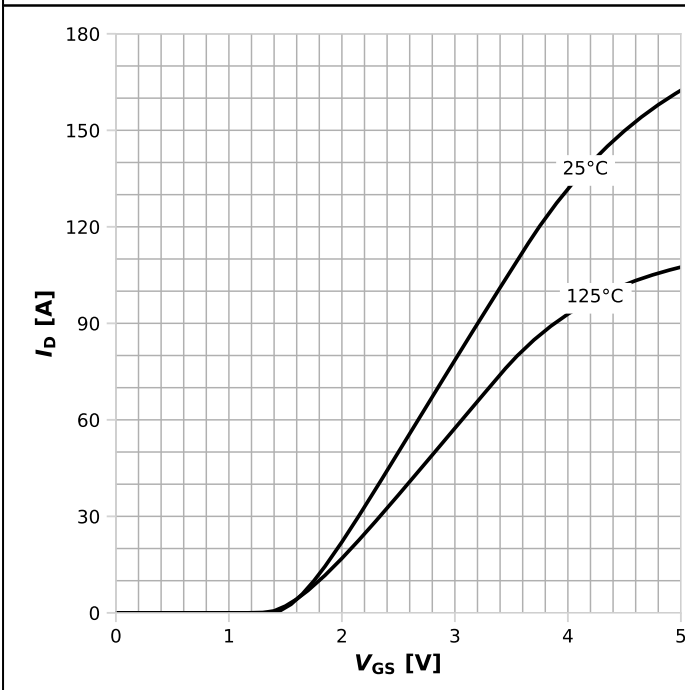
$I_{GS}=f(V_{GS}); \text{open drain}; \text{parameter: } T_j$

Diagram 12: Typ. gate characteristics reverse



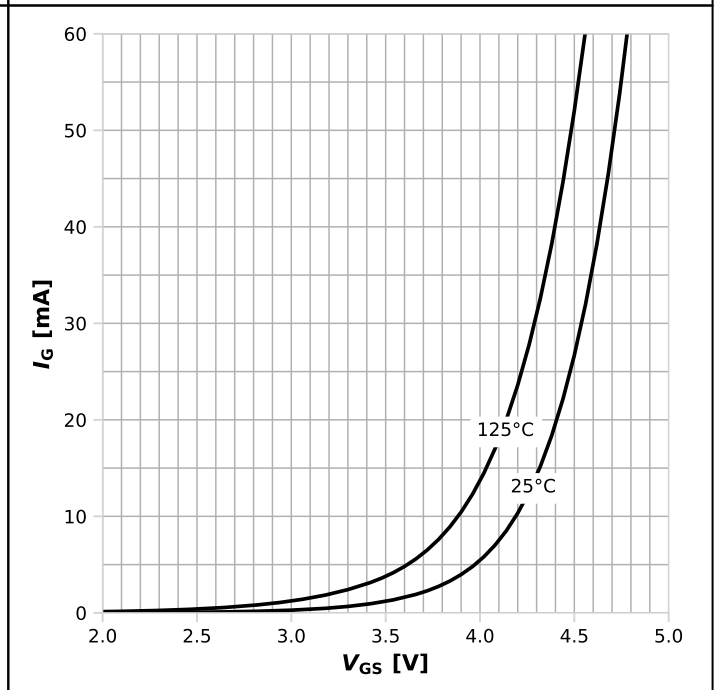
$I_{SG}=f(V_{SG}); \text{parameter: } T_j$

Diagram 13: Typ. transfer characteristics



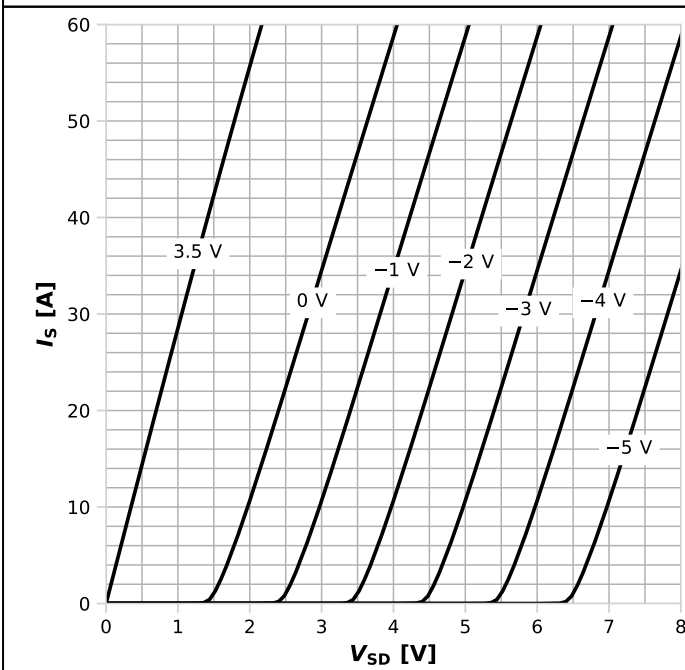
$I_D = f(V_{GS}); V_{DS} = 8V; \text{parameter: } T_j$

Diagram 14: Typ. transfer gate current characteristic



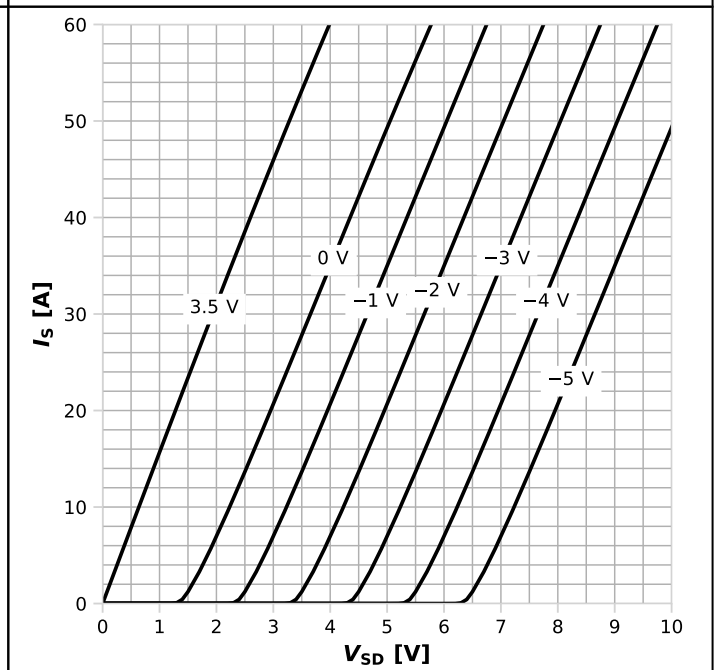
$I_G = f(V_{GS}); V_{DS} = 8V; \text{parameter: } T_j$

Diagram 15: Typ. channel reverse characteristics



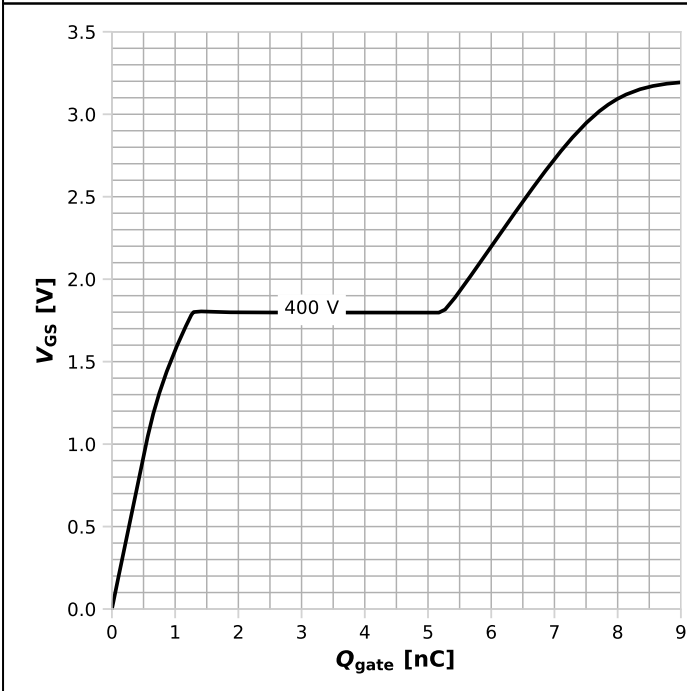
$I_S = f(V_{SD}); T_j = 25^\circ\text{C}; \text{parameter: } V_{GS}$

Diagram 16: Typ. channel reverse characteristics



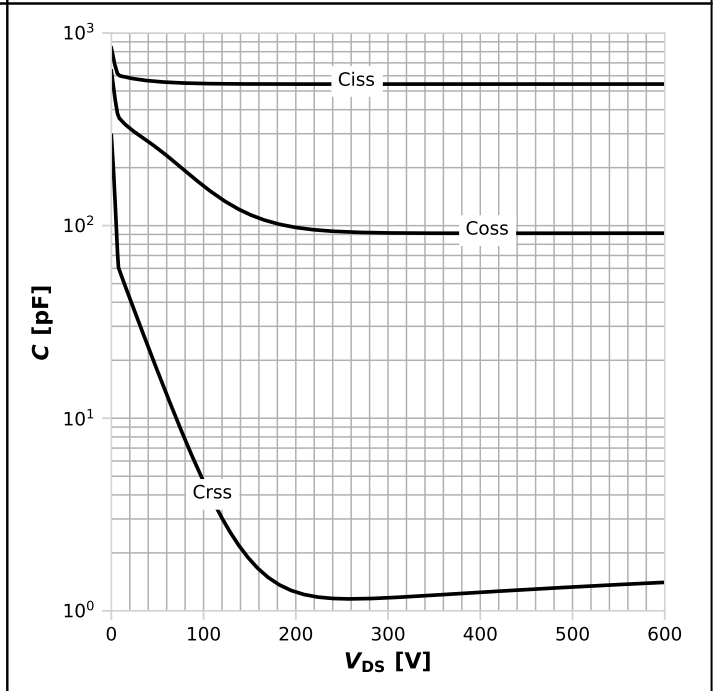
$I_S = f(V_{SD}); T_j = 125^\circ\text{C}; \text{parameter: } V_{GS}$

Diagram 17 Typ. gate charge



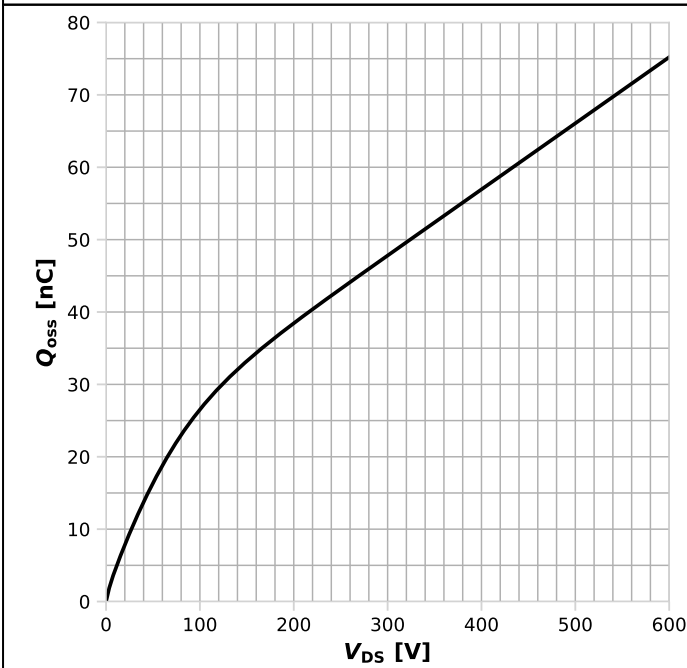
$V_{GS}=f(Q_{gate})$ ;  $I_D=13$  A pulsed;  $I_G=4.5$  mA; parameter:  $V_{DD}$

Diagram 18: Typ. capacitances



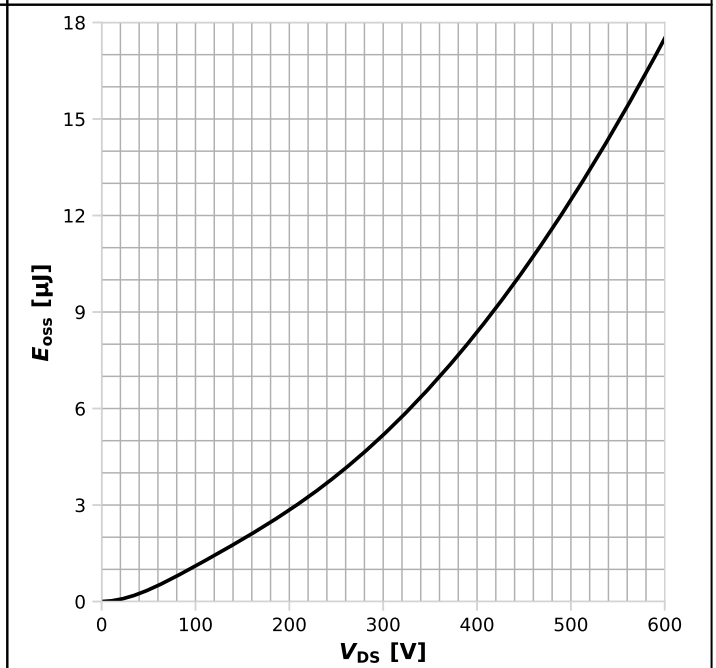
$C=f(V_{DS})$ ;  $V_{GS}=0$  V

Diagram 19: Typ. output charge



$Q_{oss}=f(V_{DS})$

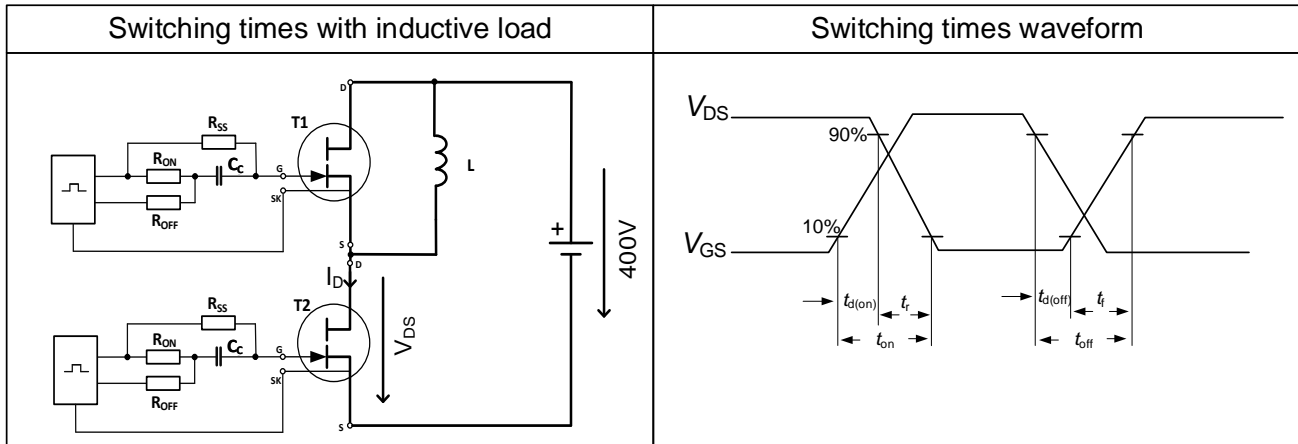
Diagram 20: Typ. Coss stored energy



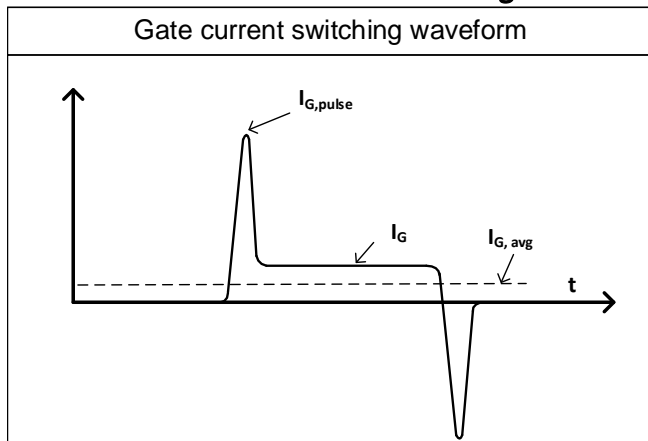
$E_{oss}=f(V_{DS})$

## 5 Test circuits

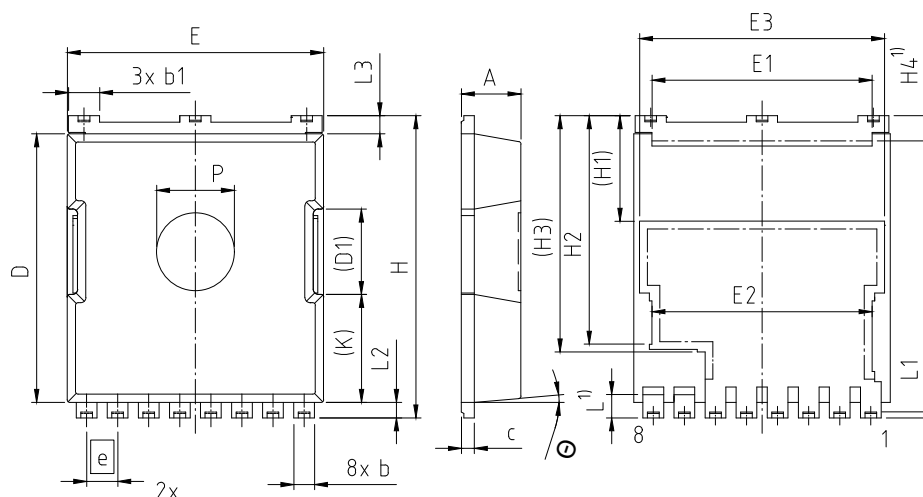
**Table 8 Reverse channel characteristics test**



**Table 9 Gate current switching waveform**



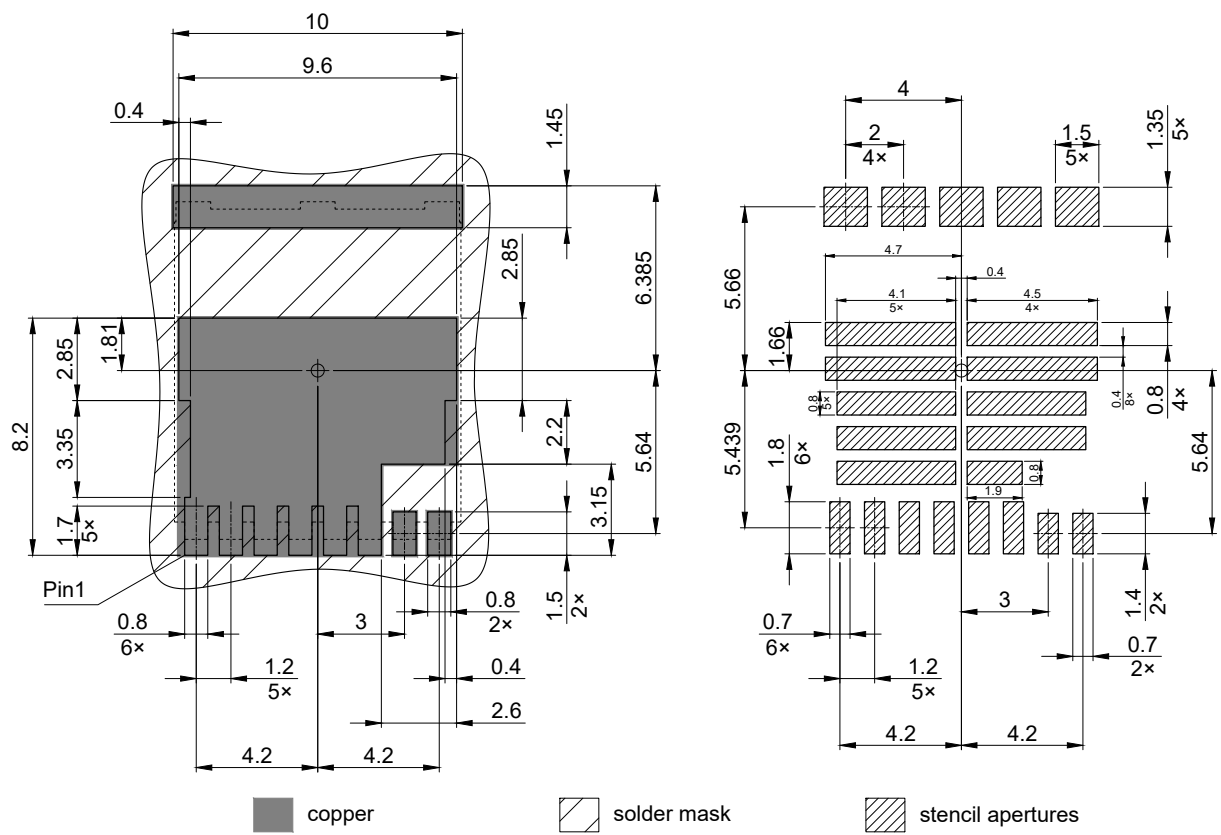
## 6 Package outlines



PACKAGE - GROUP NUMBER: PG-HSOF-8-U04		
DIMENSIONS	MILLIMETERS	
	MIN.	MAX.
A	2.20	2.40
b	0.70	0.90
b1	1.10	1.30
c	0.40	0.60
D	10.275	10.575
D1	(3.20)	(3.40)
E	9.70	10.10
E1	8.40	8.60
E2	8.40	8.60
E3	9.36	9.56
e	1.20	
H	11.475	11.875
H1	(3.98)	(4.18)
H2	8.73	8.93
H3	(9.03)	(9.23)
H4	0.88	1.08
N	8	
K	(4.07)	(4.27)
L	0.80	1.00
L1	0.13	0.33
L2	0.50	0.70
L3	0.60	0.80
P	2.90	3.10
Θ	3.5°	6.5°

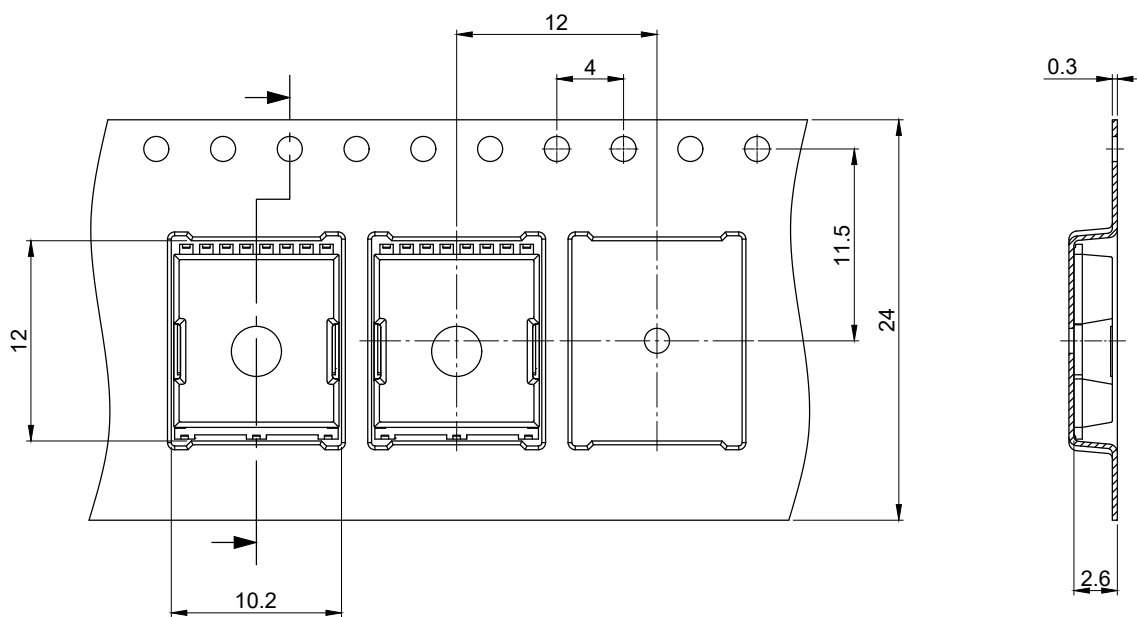
NOTES:  
1) LEAD LENGTH UP TO ANTI FLASH PROFILE, MOLD FLASHES EXCLUDED

Figure 1 Outline PG-HSOF-8, dimensions in mm



Based on stencil thickness 0.130 mm  
 All dimensions are in units mm

**Figure 2 Footprint drawing PG-HSOF-8, dimensions in mm**



All dimensions are in units mm  
The drawing is in compliance with ISO 128-30, Projection Method 1 [⊥]

**Figure 3** Packaging variant PG-HSOF-8, dimensions in mm



## 7 Appendix A

Table 10 Related links

- [CoolGaN™ GaN 650 V webpage](#)
- [CoolGaN™ GaN 650 V reliability white paper](#)
- [CoolGaN™ GaN 650 V gate driver application note](#)
- [CoolGaN™ GaN 650 V applications information](#)

## Revision history

IGT65R035D2

### Revision 2024-11-28, Rev. 1.0

Previous revisions

Revision	Date	Subjects (major changes since last revision)
1.0	2024-11-28	Release of final

#### Trademarks

All referenced product or service names and trademarks are the property of their respective owners.

**We Listen to Your Comments** Any information within this document that you feel is wrong, unclear or missing at all? Your feedback will help us to continuously improve the quality of this document. Please send your proposal (including a reference to this document) to: [erratum@infineon.com](mailto:erratum@infineon.com)

#### Published by

Infineon Technologies AG  
81726 München, Germany  
© 2024 Infineon Technologies AG  
All Rights Reserved.

#### Legal Disclaimer

The information given in this document shall in no event be regarded as a guarantee of conditions or characteristics ("Beschaffenheitsgarantie"). With respect to any examples, hints or any typical values stated herein and/or any information regarding the application of the product, Infineon Technologies hereby disclaims any and all warranties and liabilities of any kind, including without limitation warranties of non-infringement of intellectual property rights of any third party.

In addition, any information given in this document is subject to customer's compliance with its obligations stated in this document and any applicable legal requirements, norms and standards concerning customer's products and any use of the product of Infineon Technologies in customer's applications.

The data contained in this document is exclusively intended for technically trained staff. It is the responsibility of customer's technical departments to evaluate the suitability of the product for the intended application and the completeness of the product information given in this document with respect to such application.

#### Information

For further information on technology, delivery terms and conditions and prices please contact your nearest Infineon Technologies Office ([www.infineon.com](http://www.infineon.com)).

#### Warnings

Due to technical requirements, components may contain dangerous substances. For information on the types in question, please contact the nearest Infineon Technologies Office.

The Infineon Technologies component described in this Data Sheet may be used in life-support devices or systems and/or automotive, aviation and aerospace applications or systems only with the express written approval of Infineon Technologies, if a failure of such components can reasonably be expected to cause the failure of that life-support, automotive, aviation and aerospace device or system or to affect the safety or effectiveness of that device or system. Life support devices or systems are intended to be implanted in the human body or to support and/or maintain and sustain and/or protect human life. If they fail, it is reasonable to assume that the health of the user or other persons may be endangered.