

SiC MOSFET

CoolSiC™ MOSFET 650 V G2

Built on Infineon's robust 2nd generation Silicon Carbide trench technology, the 650 V CoolSiC™ MOSFET delivers unparalleled performance, superior reliability, and great ease of use. It enables cost effective, highly efficient, and simplified designs to fulfill the ever-growing system and market needs.

Features

- Ultra-low switching losses
- Benchmark gate threshold voltage, $V_{GS(th)} = 4.5\text{ V}$
- Robust against parasitic turn-on even with 0 V turn-off gate voltage
- Flexible driving voltage and compatible with bipolar driving scheme
- Robust body diode operation under hard commutation events
- .XT interconnection technology for best-in-class thermal performance

Benefits

- Enables high efficiency and high power density designs
- Facilitates great ease of use and integration
- Provides the best price performance ratio compared to Industry's most ambitious roadmaps
- Reduces the size, weight and bill of materials of the systems
- Enhances system robustness and reliability

Potential applications

- SMPS
- Solar PV inverters
- Energy storage and battery formation
- UPS
- EV charging infrastructure
- Motor drives

Product validation

Fully qualified according to JEDEC for Industrial Applications

Please note: The source and driver source pins are not exchangeable. Their exchange might lead to malfunction.

Table 1 Key Performance Parameters

Parameter	Value	Unit
V_{DSS} over full $T_{j,range}$	650	V
$R_{DS(on),typ}$	40	mΩ
$R_{DS(on),max}$	49	mΩ
$Q_{G,typ}$	28	nC
$I_{D,pulse}$	143	A
$Q_{oss} @ 400\text{ V}$	53	nC
$E_{oss} @ 400\text{ V}$	7.2	μJ

Type/Ordering Code	Package	Marking	Related Links
IMLT65R040M2H	PG-HDSOP-16	65R040M2	see Appendix A

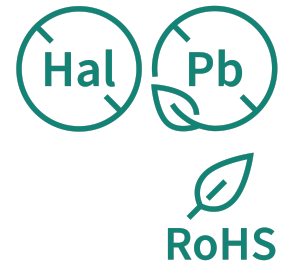
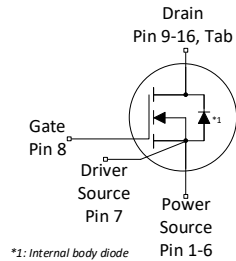
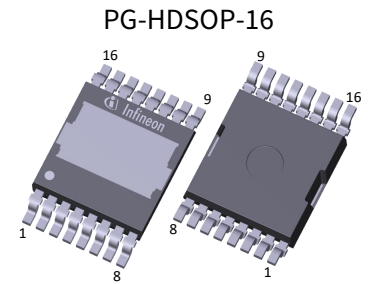

Table of Contents

Description	1
Maximum ratings	3
Thermal characteristics	4
Operating range	5
Electrical characteristics	6
Electrical characteristics diagrams	9
Test Circuits	14
Package Outlines	15
Appendix A	18
Revision History	19
Trademarks	19
Disclaimer	19

1 Maximum ratings

at $T_j = 25\text{ °C}$, unless otherwise specified.

Note: for optimum lifetime and reliability, Infineon recommends operating conditions that do not exceed 80% of the maximum ratings stated in this datasheet.

Table 2 Maximum ratings

Parameter	Symbol	Values			Unit	Note/ Test Condition
		Min.	Typ.	Max.		
Continuous DC drain current ¹⁾	I_{DDC}	-	-	57 40	A	$T_c = 25\text{ °C}$ $T_c = 100\text{ °C}$
Peak drain current ²⁾	I_{DM}	-	-	143	A	$T_c = 25\text{ °C}$, $V_{\text{GS}} = 18\text{ V}$
Avalanche energy, single pulse	E_{AS}	-	-	132	mJ	$I_{\text{D}} = 4.9\text{ A}$, $V_{\text{DD}} = 50\text{ V}$; see table 11
Avalanche energy, repetitive	E_{AR}	-	-	0.66	mJ	$I_{\text{D}} = 4.9\text{ A}$, $V_{\text{DD}} = 50\text{ V}$; see table 11
Avalanche current, single pulse	I_{AS}	-	-	4.9	A	-
MOSFET dv/dt ruggedness	dv/dt	-	-	200	V/ns	$V_{\text{DS}} = 0 \dots 400\text{ V}$
Gate source voltage (static) ³⁾	V_{GS}	-7	-	23	V	-
Gate source voltage (transient)	V_{GS}	-10	-	25	V	$t_p \leq 500\text{ ns}$, duty cycle $\leq 1\%$
Power dissipation	P_{tot}	-	-	268	W	$T_c = 25\text{ °C}$
Storage temperature	T_{stg}	-55	-	150	°C	-
Operating junction temperature	T_j	-55	-	175	°C	-
Mounting torque	-	-	-	-	Ncm	-
Continuous reverse drain current ¹⁾	I_{SDC}	-	-	57 39	A	$V_{\text{GS}} = 18\text{ V}$, $T_c = 25\text{ °C}$ $V_{\text{GS}} = 0\text{ V}$, $T_c = 25\text{ °C}$
Peak reverse drain current ²⁾	I_{SM}	-	-	143 43	A	$T_c = 25\text{ °C}$, $t_p \leq 250\text{ ns}$ $T_c = 25\text{ °C}$
Insulation withstand voltage	V_{ISO}	-	-	n.a.	V	V_{rms} , $T_c = 25\text{ °C}$, $t = 1\text{ min}$

1) Limited by $T_{j,\text{max}}$.

2) Pulse width t_{pulse} limited by $T_{j,\text{max}}$.

3) The maximum gate-source voltage in the application design should be in accordance to IPC-9592B.

2 Thermal characteristics

Table 3 Thermal characteristics

Parameter	Symbol	Values			Unit	Note/ Test Condition
		Min.	Typ.	Max.		
Thermal resistance, junction - case	$R_{th(j-c)}$	-	-	0.56	°C/W	Not subject to production test. Parameter verified by design/characterization according to JESD51-14.
Soldering temperature, reflow soldering allowed	T_{sold}	-	-	260	°C	reflow MSL1

3 Operating range

Table 4 Operating range

Parameter	Symbol	Values			Unit	Note/ Test Condition
		Min.	Typ.	Max.		
Recommended turn-on voltage	$V_{GS(on)}$	-	18	-	V	-
Recommended turn-off voltage	$V_{GS(off)}$	-	0	-	V	-

4 Electrical characteristics

at $T_j = 25\text{ °C}$, unless otherwise specified

Table 5 Static characteristics

Parameter	Symbol	Values			Unit	Note/ Test Condition
		Min.	Typ.	Max.		
Drain-source voltage	V_{DSS}	650	-	-	V	$V_{GS} = 0\text{ V}$, $I_D = 0.46\text{ mA}$
Gate threshold voltage ⁴⁾	$V_{GS(th)}$	3.5	4.5	5.6	V	$V_{DS} = V_{GS}$, $I_D = 4.6\text{ mA}$
Zero gate voltage drain current	I_{DSS}	-	1 3	75 -	μA	$V_{DS} = 650\text{ V}$, $V_{GS} = 0\text{ V}$, $T_j = 25\text{ °C}$ $V_{DS} = 650\text{ V}$, $V_{GS} = 0\text{ V}$, $T_j = 175\text{ °C}$
Gate-source leakage current	I_{GSS}	-	-	100	nA	$V_{GS} = 20\text{ V}$, $V_{DS} = 0\text{ V}$
Drain-source on-state resistance	$R_{DS(on)}$	-	52 40 36 65	- 49 - -	m Ω	$V_{GS} = 15\text{ V}$, $I_D = 22.9\text{ A}$, $T_j = 25\text{ °C}$ $V_{GS} = 18\text{ V}$, $I_D = 22.9\text{ A}$, $T_j = 25\text{ °C}$ $V_{GS} = 20\text{ V}$, $I_D = 22.9\text{ A}$, $T_j = 25\text{ °C}$ $V_{GS} = 18\text{ V}$, $I_D = 22.9\text{ A}$, $T_j = 175\text{ °C}$
Internal gate resistance	$R_{G,int}$	-	3.4	-	Ω	$f = 1\text{ MHz}$

⁴⁾ Tested after 1 ms pulse at $V_{GS} = +20\text{ V}$. "Linear mode" operation is not recommended. For assessment of potential "linear mode" operation, please contact Infineon sales office.

Table 6 Dynamic characteristics

External parasitic elements (PCB layout) influence switching behavior significantly. Stray inductances and coupling capacitances must be minimized. For layout recommendations please use provided application notes or contact Infineon sales office.

Parameter	Symbol	Values			Unit	Note/ Test Condition
		Min.	Typ.	Max.		
Input capacitance	C_{iss}	-	997	-	pF	$V_{GS} = 0\text{ V}$, $V_{DS} = 400\text{ V}$, $f = 250\text{ kHz}$
Reverse transfer capacitance	C_{rss}	-	5.8	-	pF	$V_{GS} = 0\text{ V}$, $V_{DS} = 400\text{ V}$, $f = 250\text{ kHz}$
Output capacitance ⁵⁾	C_{oss}	-	74	96	pF	$V_{GS} = 0\text{ V}$, $V_{DS} = 400\text{ V}$, $f = 250\text{ kHz}$
Output charge ⁵⁾	Q_{oss}	-	53	69	nC	calculation based on C_{oss}
Effective output capacitance, energy related ⁶⁾	$C_{o(er)}$	-	90	-	pF	$V_{GS} = 0\text{ V}$, $V_{DS} = 0...400\text{ V}$
Effective output capacitance, time related ⁷⁾	$C_{o(tr)}$	-	133	-	pF	$I_D = \text{constant}$, $V_{GS} = 0\text{ V}$, $V_{DS} = 0...400\text{ V}$
Turn-on delay time	$t_{d(on)}$	-	8.4	-	ns	$V_{DD} = 400\text{ V}$, $V_{GS} = 0/18\text{ V}$, $I_D = 22.9\text{ A}$, $R_{G,ext} = 1.8\text{ }\Omega$; see table 10
Rise time	t_r	-	8.3	-	ns	$V_{DD} = 400\text{ V}$, $V_{GS} = 0/18\text{ V}$, $I_D = 22.9\text{ A}$, $R_{G,ext} = 1.8\text{ }\Omega$; see table 10

Table 6 Dynamic characteristics

External parasitic elements (PCB layout) influence switching behavior significantly.
 Stray inductances and coupling capacitances must be minimized.
 For layout recommendations please use provided application notes or contact Infineon sales office.

Parameter	Symbol	Values			Unit	Note/ Test Condition
		Min.	Typ.	Max.		
Turn-off delay time	$t_{d(off)}$	-	14.4	-	ns	$V_{DD} = 400\text{ V}$, $V_{GS} = 0/18\text{ V}$, $I_D = 22.9\text{ A}$, $R_{G,ext} = 1.8\ \Omega$; see table 10
Fall time	t_f	-	4.6	-	ns	$V_{DD} = 400\text{ V}$, $V_{GS} = 0/18\text{ V}$, $I_D = 22.9\text{ A}$, $R_{G,ext} = 1.8\ \Omega$; see table 10
Turn-ON switching losses ⁸⁾	E_{on}	-	30	-	μJ	$V_{DD} = 400\text{ V}$, $V_{GS} = 0/18\text{ V}$, $I_D = 22.9\text{ A}$, $R_{G,ext} = 1.8\ \Omega$
Turn-OFF switching losses ⁸⁾	E_{off}	-	16	-	μJ	$V_{DD} = 400\text{ V}$, $V_{GS} = 0/18\text{ V}$, $I_D = 22.9\text{ A}$, $R_{G,ext} = 1.8\ \Omega$
Total switching losses ⁸⁾	E_{tot}	-	46	-	μJ	$V_{DD} = 400\text{ V}$, $V_{GS} = 0/18\text{ V}$, $I_D = 22.9\text{ A}$, $R_{G,ext} = 1.8\ \Omega$

⁵⁾ Maximum specification is defined by calculated six sigma upper confidence bound

⁶⁾ $C_{o(er)}$ is a fixed capacitance that gives the same stored energy as C_{oss} while V_{DS} is rising from 0 to 400 V.

⁷⁾ $C_{o(tr)}$ is a fixed capacitance that gives the same charging time as C_{oss} while V_{DS} is rising from 0 to 400 V.

⁸⁾ Values for 4-pin configuration based on TO-263-7 measurements; MOSFET used in half-bridge configuration without external diode

Table 7 Gate charge characteristics

Parameter	Symbol	Values			Unit	Note/ Test Condition
		Min.	Typ.	Max.		
Plateau gate to source charge	$Q_{GS(pl)}$	-	7.3	-	nC	$V_{DD} = 400\text{ V}$, $I_D = 22.9\text{ A}$, $V_{GS} = 0\text{ to }18\text{ V}$
Gate to drain charge	Q_{GD}	-	5.3	-	nC	$V_{DD} = 400\text{ V}$, $I_D = 22.9\text{ A}$, $V_{GS} = 0\text{ to }18\text{ V}$
Total gate charge	Q_G	-	28	-	nC	$V_{DD} = 400\text{ V}$, $I_D = 22.9\text{ A}$, $V_{GS} = 0\text{ to }18\text{ V}$

Table 8 Reverse diode characteristics

Parameter	Symbol	Values			Unit	Note/ Test Condition
		Min.	Typ.	Max.		
Drain-source reverse voltage	V_{SD}	-	4.3	-	V	$V_{GS} = 0\text{ V}$, $I_S = 22.9\text{ A}$, $T_j = 25\text{ }^\circ\text{C}$
MOSFET forward recovery time	t_{fr}	-	12.2 7.6	-	ns	$V_{DD} = 400\text{ V}$, $I_S = 22.9\text{ A}$, $di_S/dt = 1000\text{ A}/\mu\text{s}$; see table 9 $V_{DD} = 400\text{ V}$, $I_S = 22.9\text{ A}$, $di_S/dt = 4000\text{ A}/\mu\text{s}$; see table 9

Table 8 Reverse diode characteristics

Parameter	Symbol	Values			Unit	Note/ Test Condition
		Min.	Typ.	Max.		
MOSFET forward recovery charge ⁹⁾	Q_{fr}	-	56 82	-	nC	$V_{DD} = 400\text{ V}$, $I_S = 22.9\text{ A}$, $di_S/dt = 1000\text{ A}/\mu\text{s}$; see table 9 $V_{DD} = 400\text{ V}$, $I_S = 22.9\text{ A}$, $di_S/dt = 4000\text{ A}/\mu\text{s}$; see table 9
MOSFET peak forward recovery current	I_{frm}	-	9.1 21.6	-	A	$V_{DD} = 400\text{ V}$, $I_S = 22.9\text{ A}$, $di_S/dt = 1000\text{ A}/\mu\text{s}$; see table 9 $V_{DD} = 400\text{ V}$, $I_S = 22.9\text{ A}$, $di_S/dt = 4000\text{ A}/\mu\text{s}$; see table 9

⁹⁾ Q_{fr} includes Q_{oss}

5 Electrical characteristics diagrams

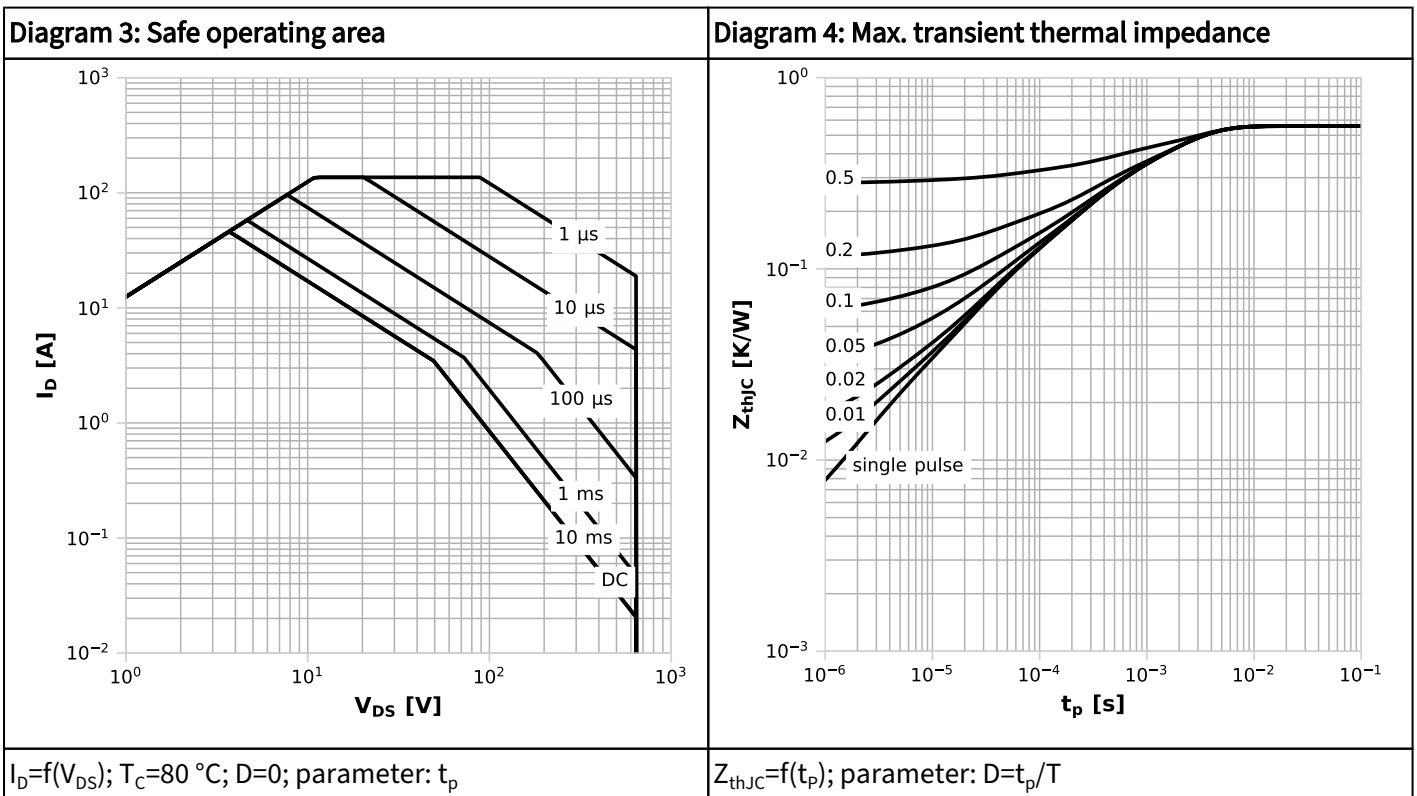
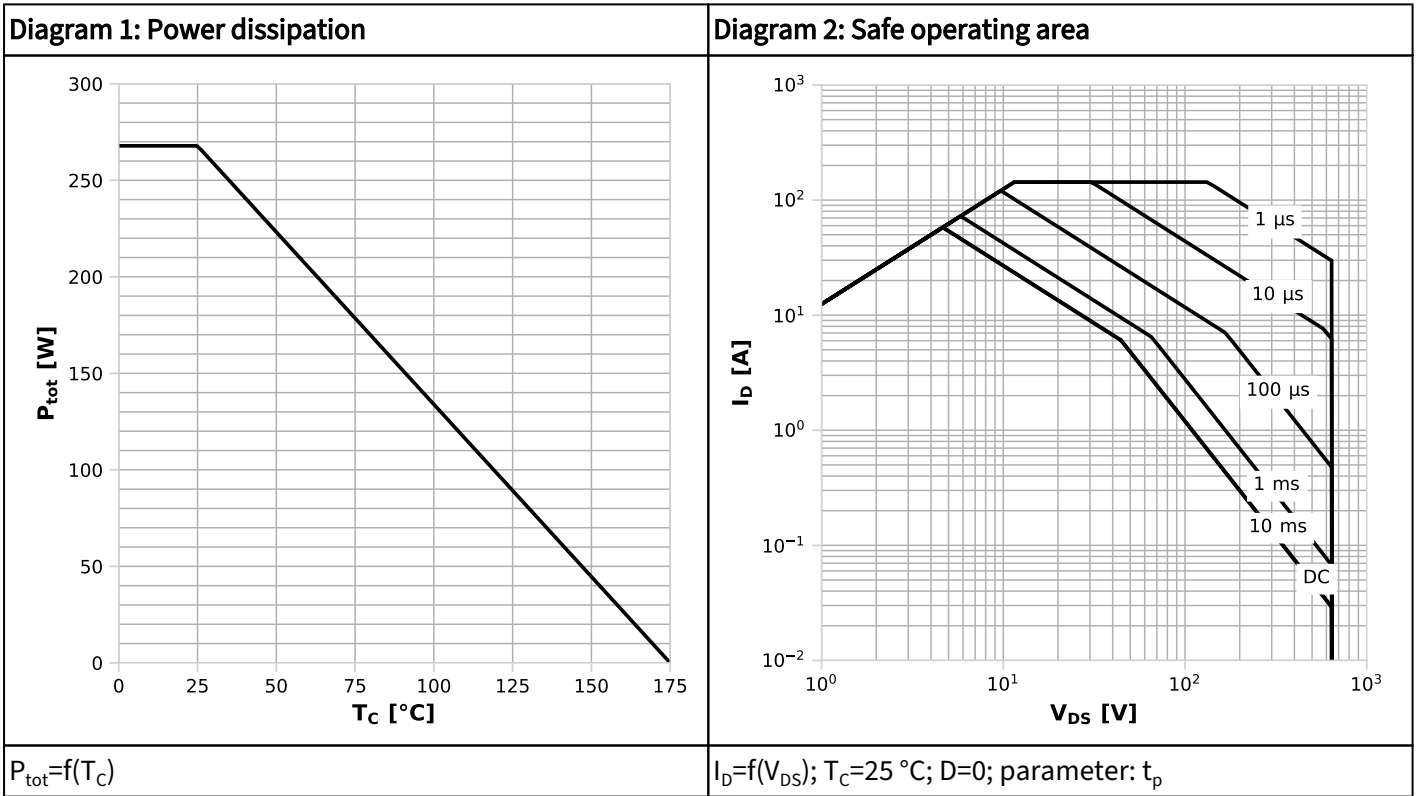
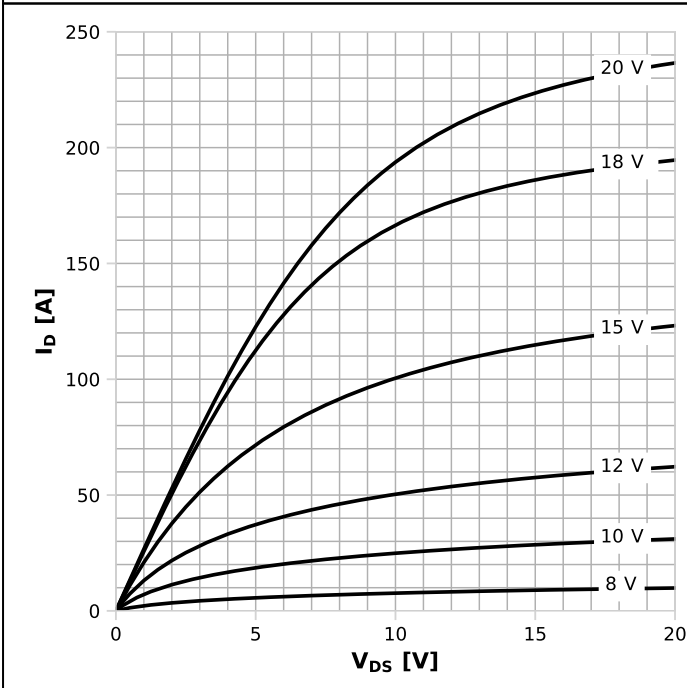
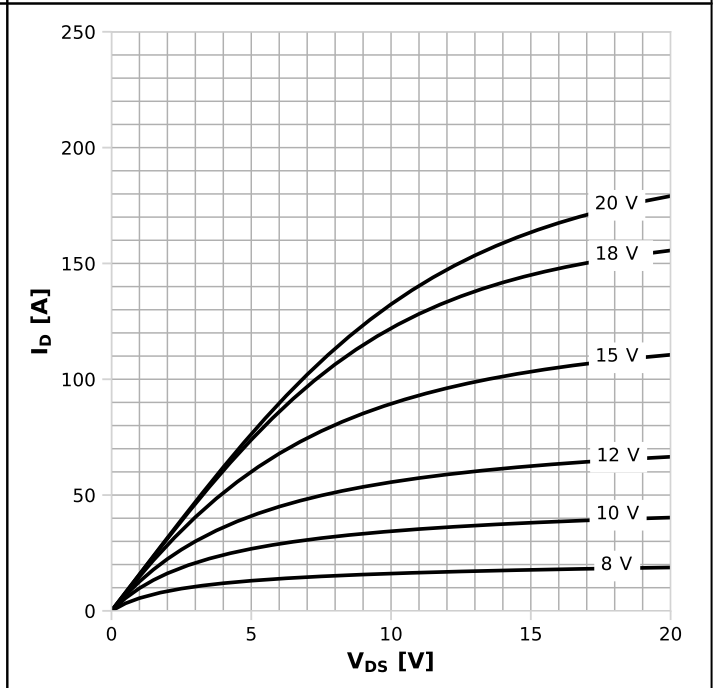

Diagram 5: Typ. output characteristics



$I_D = f(V_{DS}); T_j = 25\text{ °C};$ parameter: V_{GS}

Diagram 6: Typ. output characteristics



$I_D = f(V_{DS}); T_j = 175\text{ °C};$ parameter: V_{GS}

Diagram 7: Typ. drain-source on-state resistance

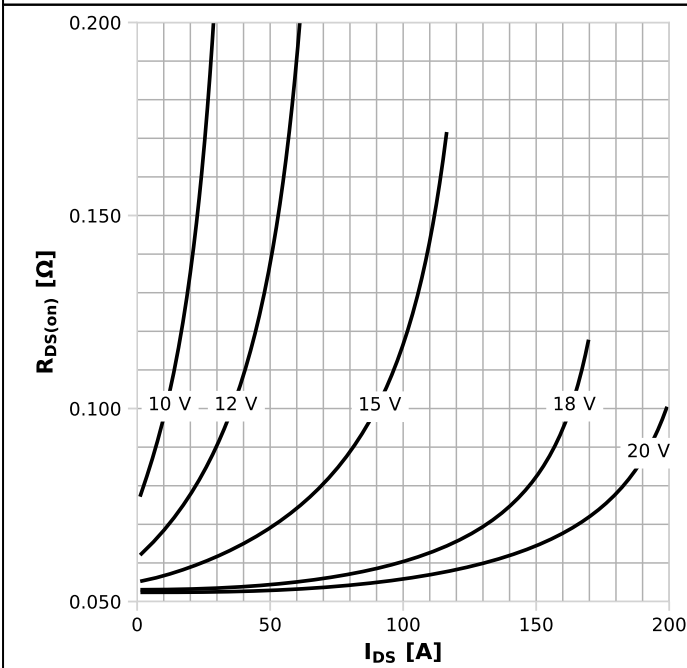

$R_{DS(on)} = f(I_{DS}); T_j = 125\text{ °C};$ parameter: V_{GS}

Diagram 8: Drain-source on-state resistance

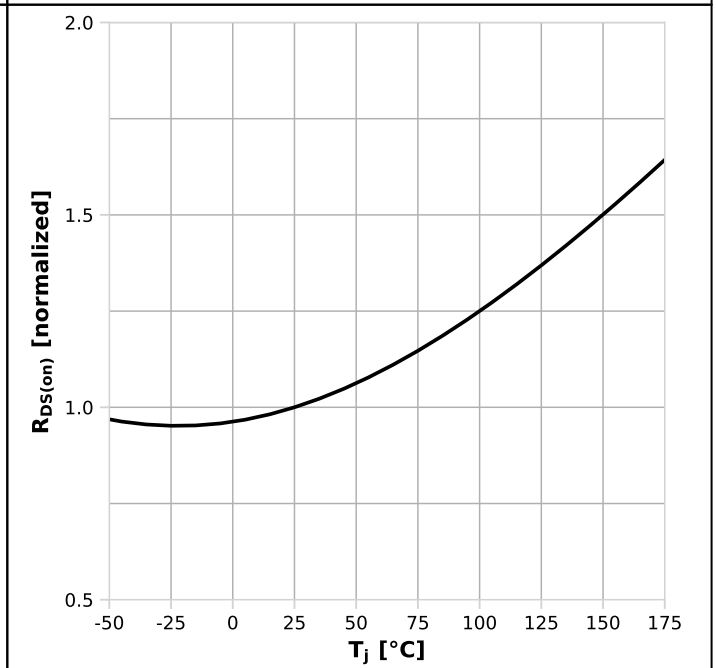

$R_{DS(on)} = f(T_j); I_D = 22.9\text{ A}; V_{GS} = 18\text{ V}$

Diagram 9: Typ. transfer characteristics

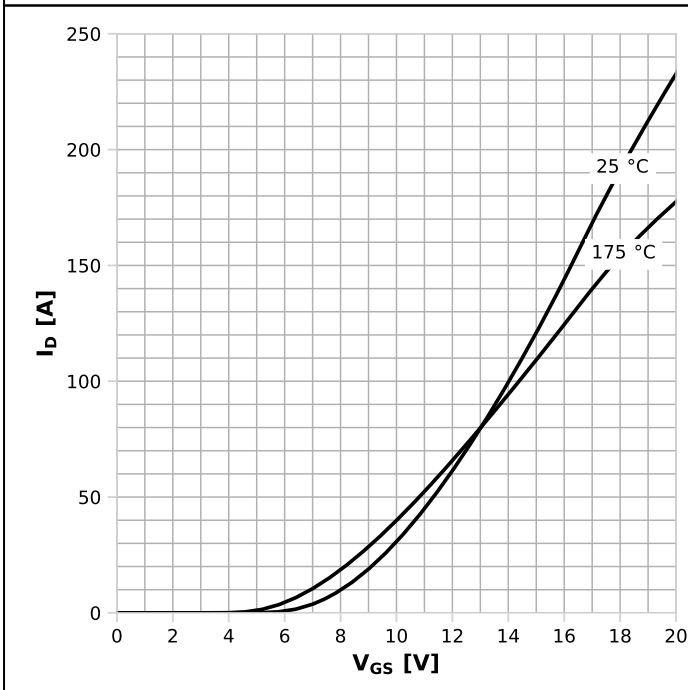

$I_D=f(V_{GS}); V_{DS}=20V$; parameter: T_j

Diagram 10: Typ. gate charge

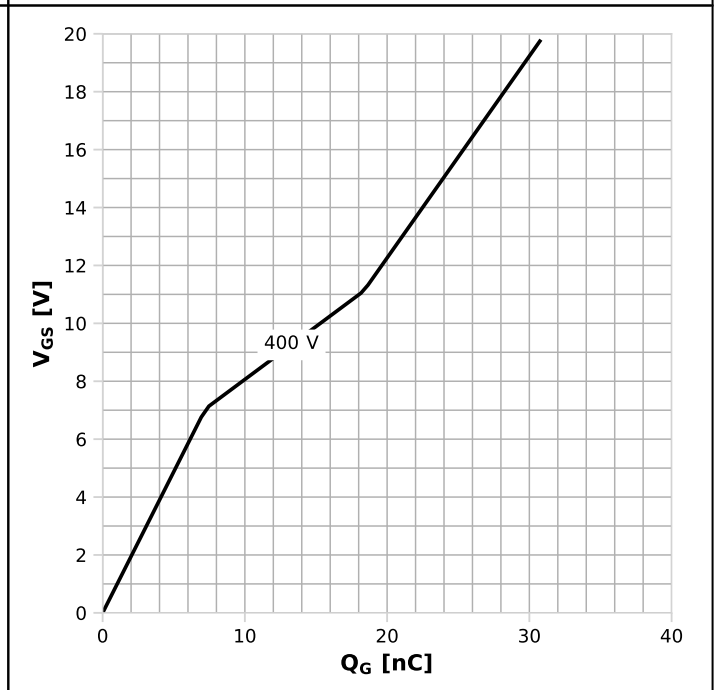

$V_{GS}=f(Q_{gate}); I_D=22.9$ A pulsed; parameter: V_{DD}

Diagram 11: Typ. reverse characteristics

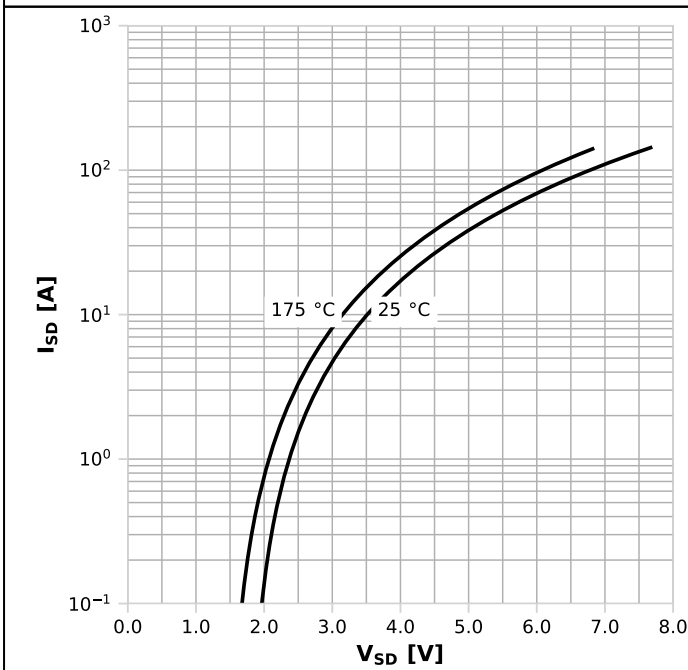

$I_{SD}=f(V_{SD}); V_{GS}=0$ V; parameter: T_j

Diagram 12: Typ. reverse characteristics

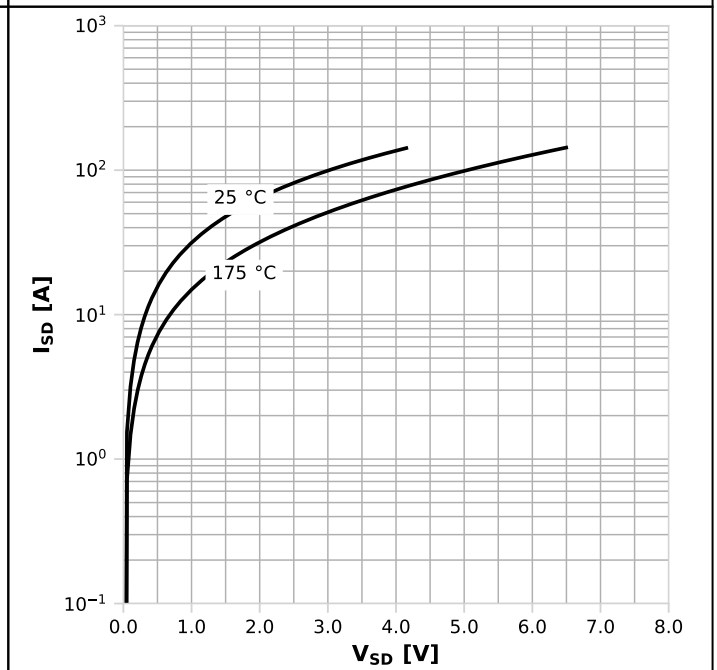

$I_{SD}=f(V_{SD}); V_{GS}=18$ V; parameter: T_j

Diagram 13: Avalanche energy

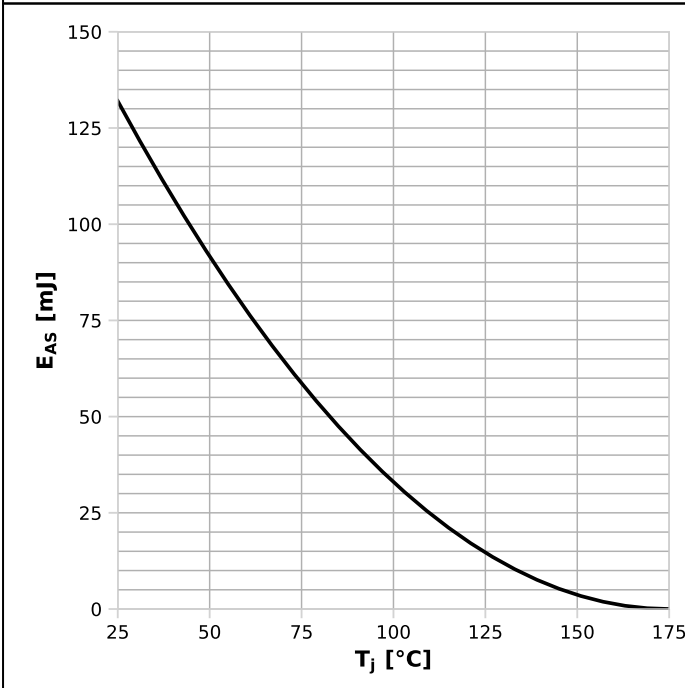

$E_{AS}=f(T_j); I_D=4.9\text{ A}; V_{DD}=50\text{ V}$

Diagram 14: Drain-source breakdown voltage

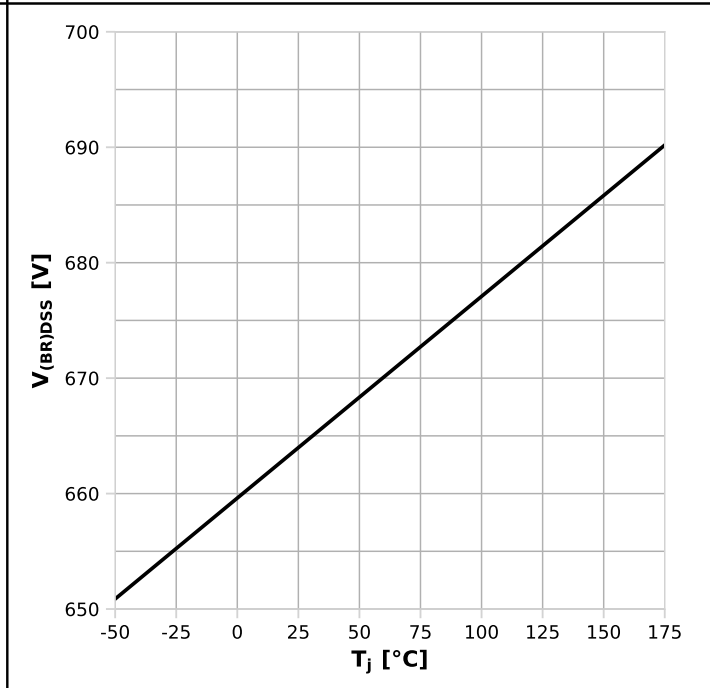

$V_{(BR)DSS}=f(T_j); I_D=0.46\text{ mA}$

Diagram 15: Typ. capacitances

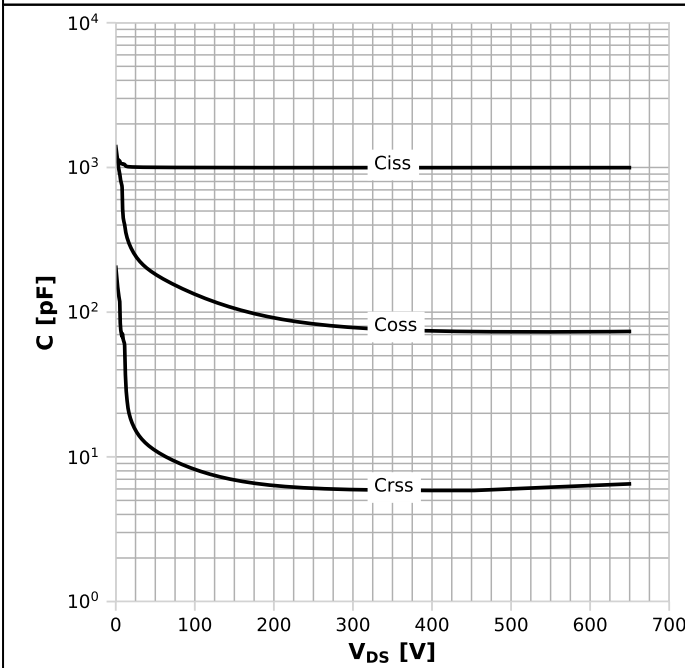

$C=f(V_{DS}); V_{GS}=0\text{ V}; f=250\text{ kHz}$

Diagram 16: Typ. Coss stored energy

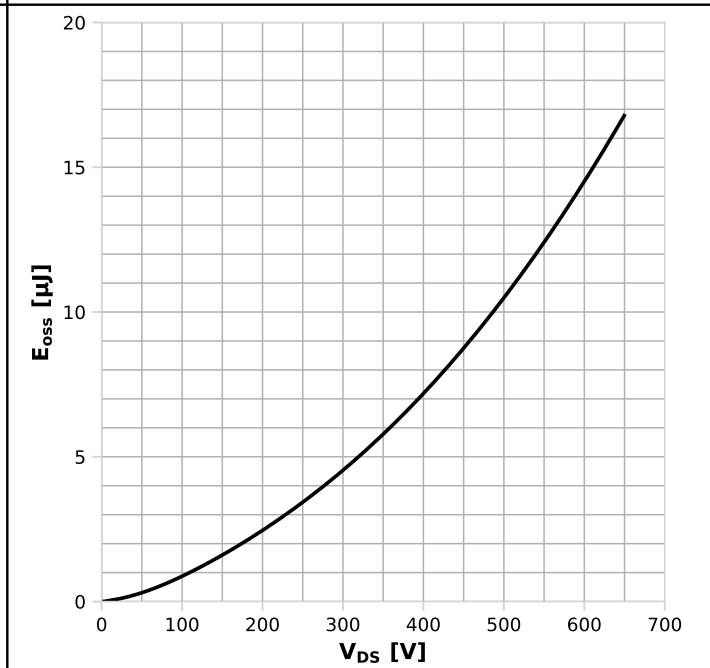

$E_{oss}=f(V_{DS})$

Diagram 17: Typ. Qoss output charge

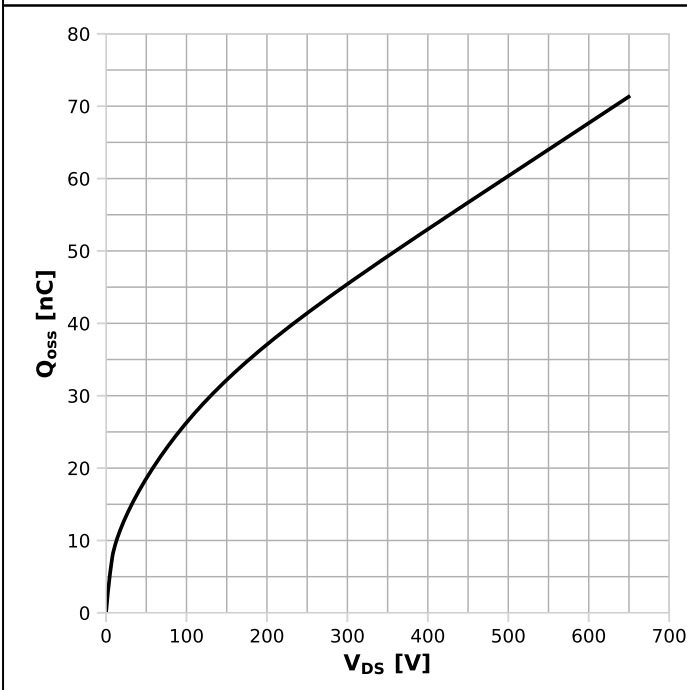

$Q_{oss}=f(V_{DS})$

Diagram 18: Typ. Switching Losses vs R_{G,ext}

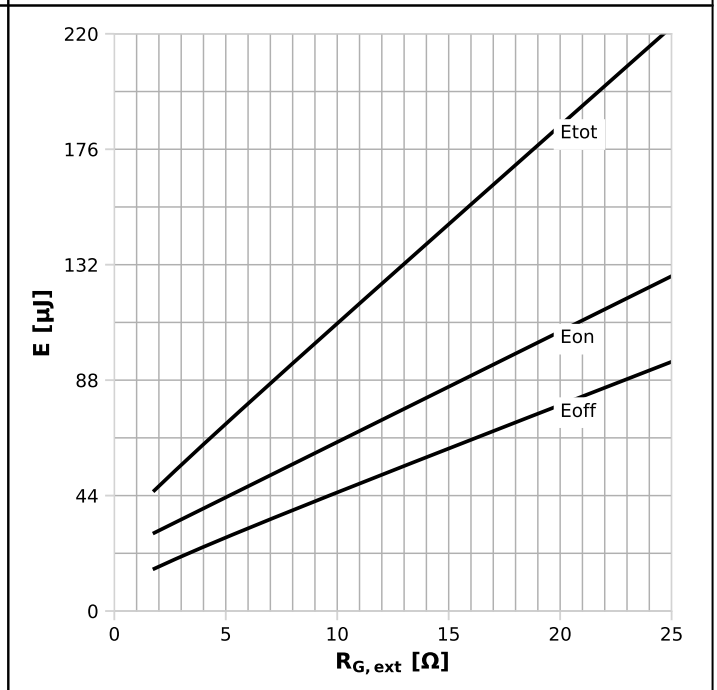

$E=f(R_{G,ext}); V_{DD}=400\text{ V}; V_{GS}=0-18\text{ V}; I_D=22.9\text{ A}$

Diagram 19: Typ. Switching Losses vs switching current

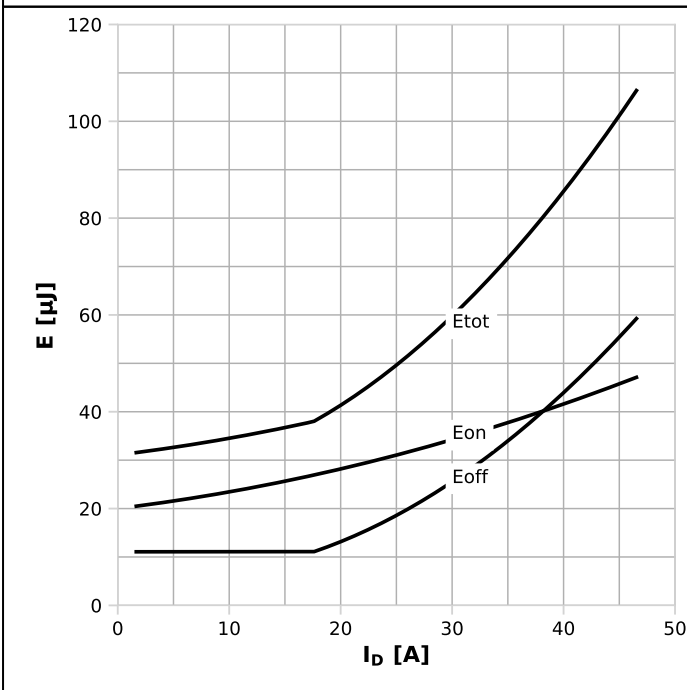

$E=f(I_D); V_{DD}=400\text{ V}; V_{GS}=0-18\text{ V}; R_{G,ext}=1.8\ \Omega$

6 Test Circuits

Table 9 Body diode characteristics (CoolSiC)

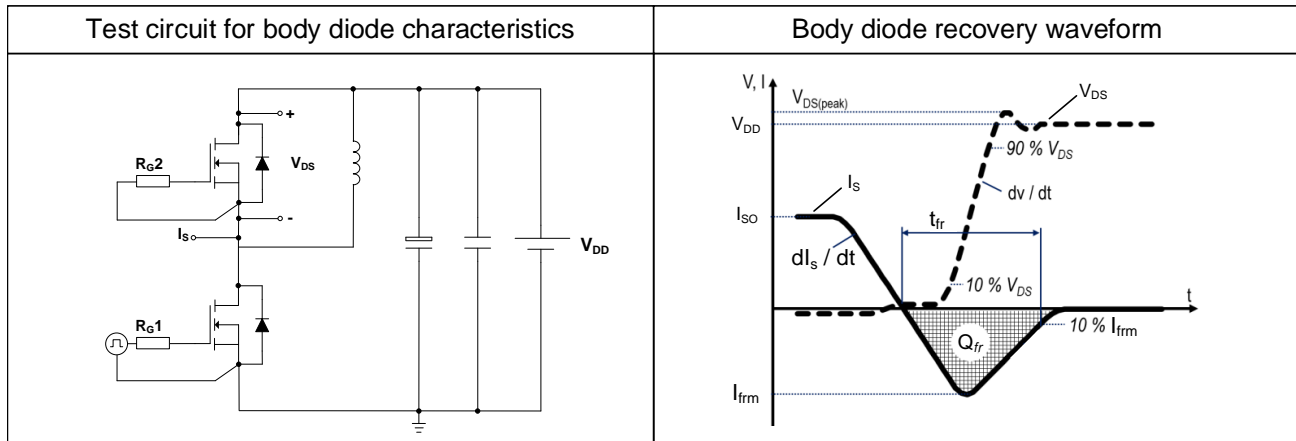

Table 10 Switching times (CoolSiC)

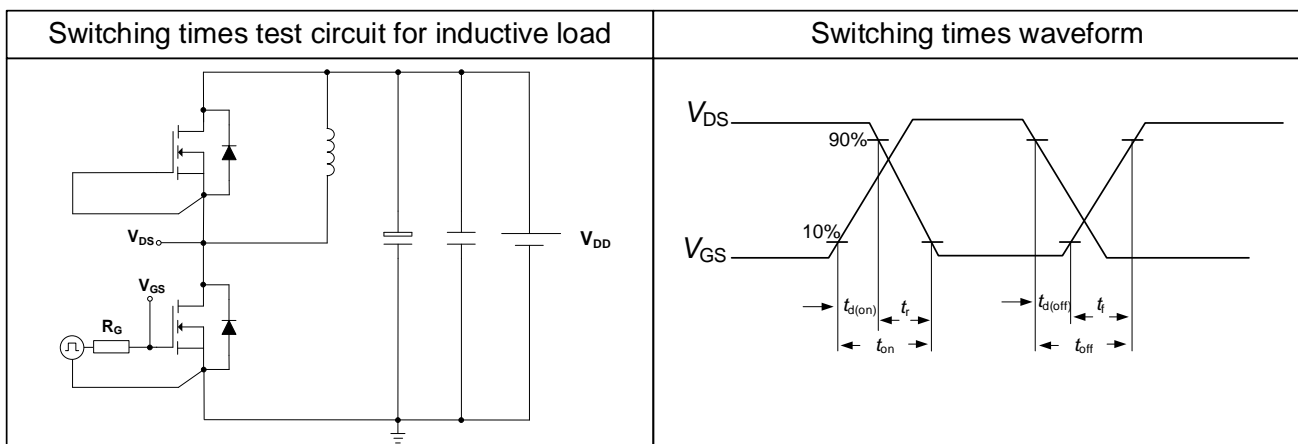
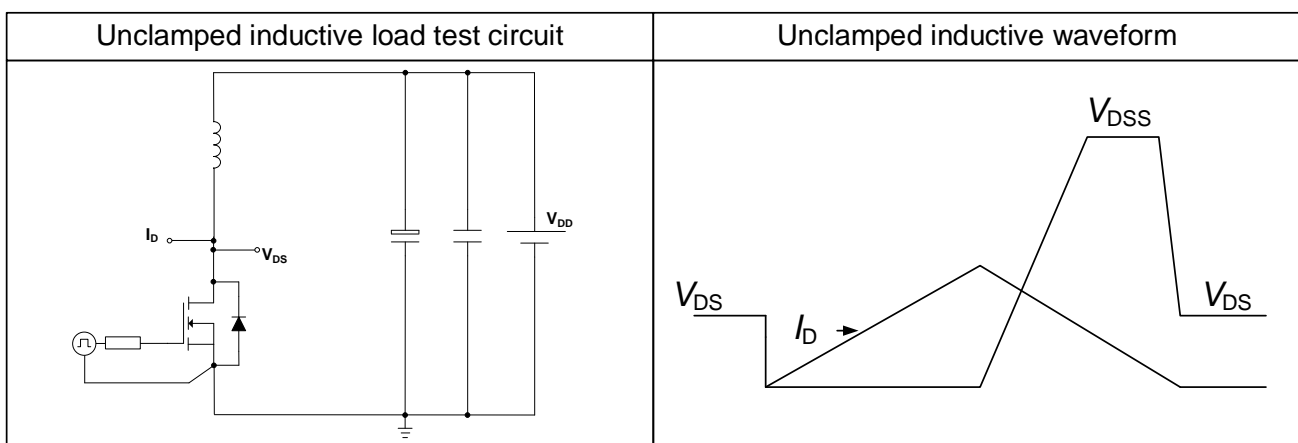

Table 11 Unclamped inductive load



7 Package Outlines

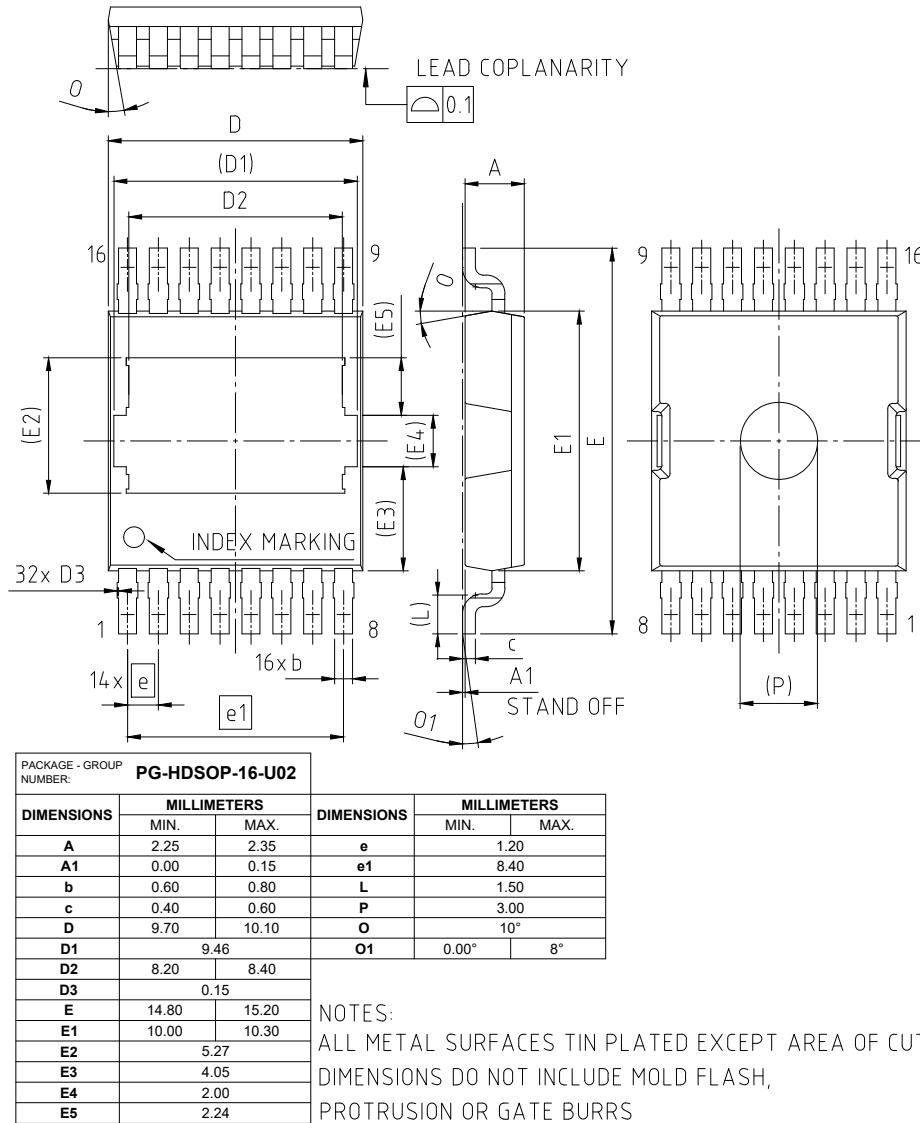

Figure 1 Outline PG-HDSOP-16, dimensions in mm

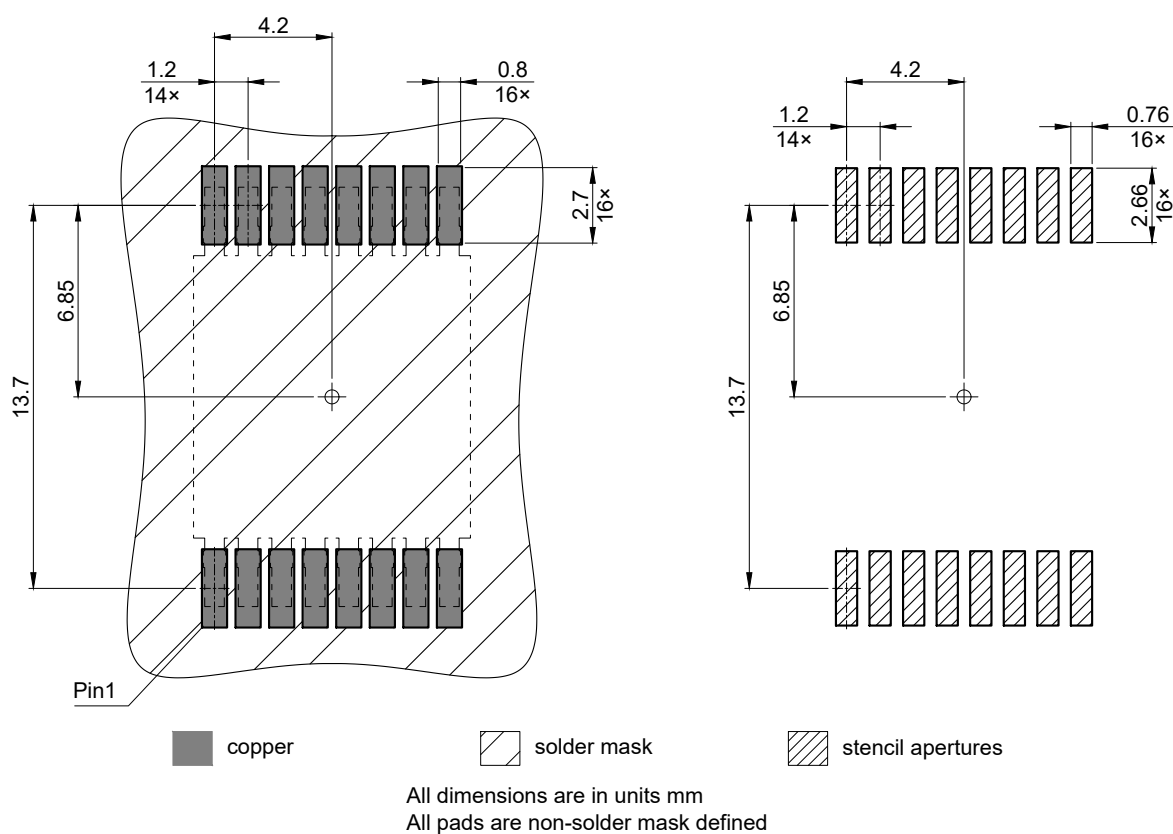
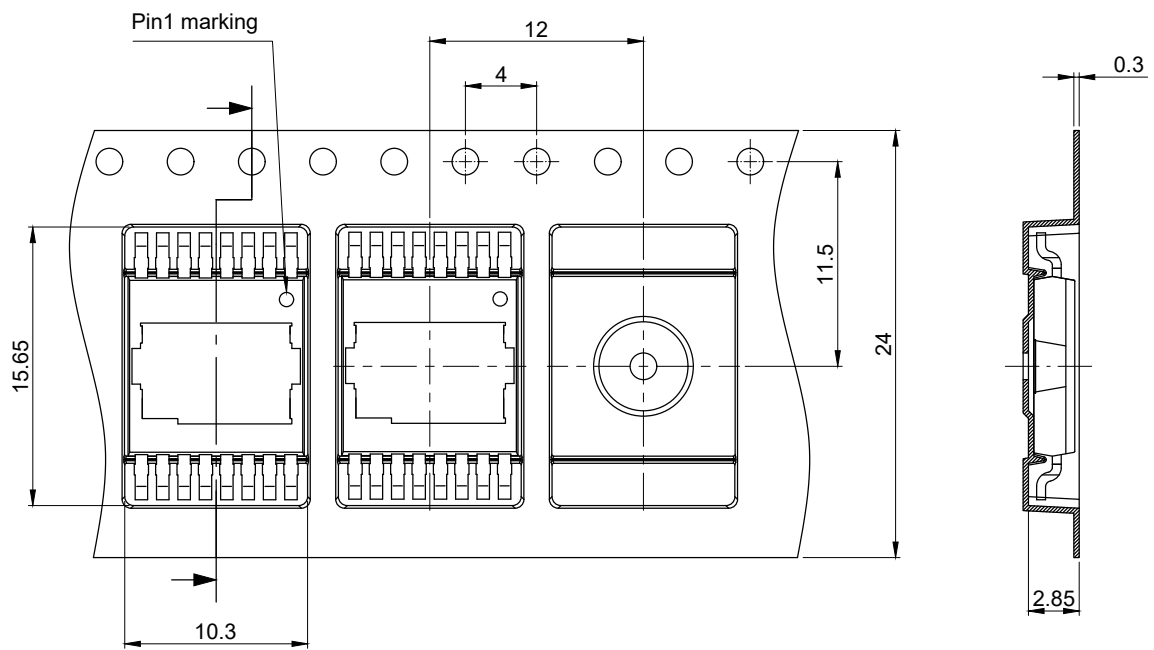

Figure 2 Outline PG-HDSOP-16, dimensions in mm



All dimensions are in units mm

The drawing is in compliance with ISO 128-30, Projection Method 1 []

Figure 3 Outline PG-HDSOP-16, dimensions in mm

8 Appendix A

Table 12 Related Links

- [IFX CoolSiC CoolSiC™ MOSFET 650 V G2 Webpage](#)
- [IFX CoolSiC CoolSiC™ MOSFET 650 V G2 Application Note](#)
- [IFX CoolSiC CoolSiC™ MOSFET 650 V G2 Simulation Model](#)
- [IFX Design tools](#)

Revision History

IMLT65R040M2H

Revision 2024-05-03, Rev. 2.0

Previous Revision

Revision	Date	Subjects (major changes since last revision)
2.0	2024-05-03	Release of final

Trademarks

All referenced product or service names and trademarks are the property of their respective owners.

We Listen to Your Comments Any information within this document that you feel is wrong, unclear or missing at all? Your feedback will help us to continuously improve the quality of this document. Please send your proposal (including a reference to this document) to: erratum@infineon.com

Published by

Infineon Technologies AG
81726 München, Germany
© 2024 Infineon Technologies AG
All Rights Reserved.

Legal Disclaimer

The information given in this document shall in no event be regarded as a guarantee of conditions or characteristics ("Beschaffenheitsgarantie"). With respect to any examples, hints or any typical values stated herein and/or any information regarding the application of the product, Infineon Technologies hereby disclaims any and all warranties and liabilities of any kind, including without limitation warranties of non-infringement of intellectual property rights of any third party.

In addition, any information given in this document is subject to customer's compliance with its obligations stated in this document and any applicable legal requirements, norms and standards concerning customer's products and any use of the product of Infineon Technologies in customer's applications.

The data contained in this document is exclusively intended for technically trained staff. It is the responsibility of customer's technical departments to evaluate the suitability of the product for the intended application and the completeness of the product information given in this document with respect to such application.

Information

For further information on technology, delivery terms and conditions and prices please contact your nearest Infineon Technologies Office (www.infineon.com).

Warnings

Due to technical requirements, components may contain dangerous substances. For information on the types in question, please contact the nearest Infineon Technologies Office.

The Infineon Technologies component described in this Data Sheet may be used in life-support devices or systems and/or automotive, aviation and aerospace applications or systems only with the express written approval of Infineon Technologies, if a failure of such components can reasonably be expected to cause the failure of that life-support, automotive, aviation and aerospace device or system or to affect the safety or effectiveness of that device or system. Life support devices or systems are intended to be implanted in the human body or to support and/or maintain and sustain and/or protect human life. If they fail, it is reasonable to assume that the health of the user or other persons may be endangered.