

## CoolMOS™ S7

### 600V CoolMOS™ SJ S7 Power Device

IPDQ60R010S7 enables the best price performance for low frequency switching applications. CoolMOS™ S7 boasts the lowest  $R_{DS(on)}$  values for a HV SJ MOSFET, with distinctive increase of energy efficiency.

CoolMOS™ S7 is optimized for “static switching” and high current applications. It is an ideal fit for solid state relay and circuit breaker designs as well as for line rectification in SMPS and inverter topologies.

### Features

- CoolMOS™ S7 technology enables 10mΩ  $R_{DS(on)}$  in the smallest footprint
- Optimized price performance in low frequency switching applications
- High pulse current capability
- Kelvin Source pin improves switching performance at high current
- QDPAK bottom side cooling package is MSL1 compliant, total Pb-free and suitable for standard PCB assembling flow, enabling simple system integration

### Benefits

- Minimized conduction losses (eliminate / reduce heat sink)
- Increased system performance
- More compact and easier design
- Lower BOM or/and TCO over prolonged life time

Compared to electromechanical devices:

- Faster switching times
- Higher reliability and longer system life time
- Shock & vibration resistance
- No contact arcing, bouncing or degradation over life time

### Potential applications

- Solid state relays and circuit breakers
- Line rectification in high power/performance applications e.g. Computing, Telecom, UPS and Solar

### Product validation

Fully qualified according to JEDEC for Industrial Applications

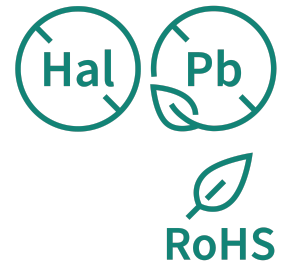
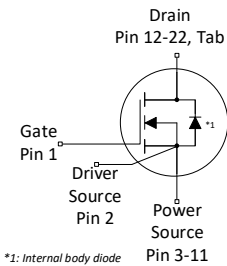
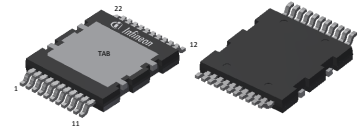
*Please note: The source and sense source pins are not exchangeable. Their exchange might lead to malfunction. For paralleling 4pin MOSFET devices the placement of the gate resistor is generally recommended to be on the Driver Source instead of the Gate.*

**Table 1 Key Performance Parameters**

Parameter	Value	Unit
$R_{DS(on),max}$	10	mΩ
$Q_{g,typ}$	318	nC
$V_{SD}$	0.82	V
Pulsed $I_{SD}, I_{DS}$	801	A

Type/Ordering Code	Package	Marking	Related Links
IPDQ60R010S7	PG-HDSOP-22	60R010S7	see Appendix A

PG-HDSOP-22





## Table of Contents

Description .....	1
Maximum ratings .....	3
Thermal characteristics .....	4
Electrical characteristics .....	5
Electrical characteristics diagrams .....	7
Test Circuits .....	11
Package Outlines .....	12
Appendix A .....	15
Revision History .....	16
Trademarks .....	16
Disclaimer .....	16

## 1 Maximum ratings

at  $T_j = 25^\circ\text{C}$ , unless otherwise specified

**Table 2 Maximum ratings**

Parameter	Symbol	Values			Unit	Note/ Test Condition
		Min.	Typ.	Max.		
Drain current rating	$I_D$	-	-	50	A	$T_C=140^\circ\text{C}$ Current is limited by $T_{j\text{max}} = 150^\circ\text{C}$ ; Lower case temp does increase current capability
Pulsed drain current <sup>1)</sup>	$I_{D,\text{pulse}}$	-	-	801	A	$T_C=25^\circ\text{C}$
Avalanche energy, single pulse	$E_{AS}$	-	-	616	mJ	$I_D=6.3\text{A}$ ; $V_{DD}=50\text{V}$ ; see table 10
Avalanche current, single pulse	$I_{AS}$	-	-	6.3	A	-
MOSFET dv/dt ruggedness <sup>2)</sup>	dv/dt	-	-	20	V/ns	$V_{DS}=0\text{V to }300\text{V}$
Gate source voltage (static)	$V_{GS}$	-20	-	20	V	static
Gate source voltage (dynamic)	$V_{GS}$	-30	-	30	V	AC ( $f>1\text{ Hz}$ )
Power dissipation	$P_{\text{tot}}$	-	-	694	W	$T_C=25^\circ\text{C}$
Storage temperature	$T_{\text{stg}}$	-55	-	150	$^\circ\text{C}$	-
Operating junction temperature	$T_j$	-55	-	150	$^\circ\text{C}$	-
Extended operating junction temperature	$T_j$	150	-	175	$^\circ\text{C}$	$\leq 50\text{ h}$ in the application lifetime
Mounting torque	-	-	-	n.a.	Ncm	-
Diode forward current rating	$I_S$	-	-	50	A	$T_C=140^\circ\text{C}$ Current is limited by $T_{j\text{max}} = 150^\circ\text{C}$ ; Lower case temp does increase current capability
Diode pulse current <sup>1)</sup>	$I_{S,\text{pulse}}$	-	-	801	A	$T_C=25^\circ\text{C}$
Reverse diode dv/dt <sup>3)</sup>	dv/dt	-	-	5	V/ns	$V_{DS}=0\text{ to }300\text{V}$ , $I_{SD}\leq 50\text{A}$ , $T_j=25^\circ\text{C}$ see table 8
Maximum diode commutation speed	$di_f/dt$	-	-	1000	A/ $\mu\text{s}$	$V_{DS}=0\text{ to }300\text{V}$ , $I_{SD}\leq 50\text{A}$ , $T_j=25^\circ\text{C}$ see table 8
Insulation withstand voltage	$V_{\text{ISO}}$	-	-	n.a.	V	$V_{\text{rms}}$ , $T_C=25^\circ\text{C}$ , $t=1\text{min}$

<sup>1)</sup> Pulse width  $t_p$  limited by  $T_{j\text{max}}$

<sup>2)</sup> The dv/dt has to be limited by appropriate gate resistor

<sup>3)</sup> Identical low side and high side switch

## 2 Thermal characteristics

**Table 3 Thermal characteristics**

Parameter	Symbol	Values			Unit	Note/ Test Condition
		Min.	Typ.	Max.		
Thermal resistance, junction - case	$R_{thJC}$	-	-	0.18	°C/W	-
Thermal resistance, junction - ambient	$R_{thJA}$	-	-	62	°C/W	device on PCB, minimal footprint
Thermal resistance, junction - ambient for SMD version	$R_{thJA}$	-	45	55	°C/W	Device on 40mm*40mm*1.5mm epoxy PCB FR4 with 6cm <sup>2</sup> (one layer, 70μm thickness) copper area. Tap exposed to air. PCB is vertical without air stream cooling.
Soldering temperature, reflow soldering allowed	$T_{sold}$	-	-	260	°C	reflow MSL1

### 3 Electrical characteristics

at  $T_j=25^\circ\text{C}$ , unless otherwise specified

**Table 4 Static characteristics**

For applications with applied blocking voltage >70% of the specified blocking voltage, it is required that the customer evaluates the impact of cosmic radiation effect in early design phase and contacts the Infineon sales office for the necessary technical support by Infineon

Parameter	Symbol	Values			Unit	Note/ Test Condition
		Min.	Typ.	Max.		
Drain-source breakdown voltage	$V_{(BR)DSS}$	600	-	-	V	$V_{GS}=0V, I_D=1mA$
Gate threshold voltage	$V_{(GS)th}$	3.5	4.0	4.5	V	$V_{DS}=V_{GS}, I_D=3.08mA$
Zero gate voltage drain current	$I_{DSS}$	-	- 80	8	$\mu A$	$V_{DS}=600V, V_{GS}=0V, T_j=25^\circ C$ $V_{DS}=600V, V_{GS}=0V, T_j=150^\circ C$
Gate-source leakage current	$I_{GSS}$	-	-	100	nA	$V_{GS}=20V, V_{DS}=0V$
Drain-source on-state resistance	$R_{DS(on)}$	-	0.009 0.022	0.010	$\Omega$	$V_{GS}=12V, I_D=50A, T_j=25^\circ C$ $V_{GS}=12V, I_D=50A, T_j=150^\circ C$
Gate resistance	$R_G$	-	0.45	-	$\Omega$	$f=1MHz, \text{open drain}$

**Table 5 Dynamic characteristics**

Parameter	Symbol	Values			Unit	Note/ Test Condition
		Min.	Typ.	Max.		
Input capacitance	$C_{iss}$	-	11986	-	pF	$V_{GS}=0V, V_{DS}=300V, f=250kHz$
Output capacitance	$C_{oss}$	-	188	-	pF	$V_{GS}=0V, V_{DS}=300V, f=250kHz$
Effective output capacitance, energy related <sup>4)</sup>	$C_{o(er)}$	-	644	-	pF	$V_{GS}=0V, V_{DS}=0 \text{ to } 300V$
Effective output capacitance, time related <sup>5)</sup>	$C_{o(tr)}$	-	5717	-	pF	$I_D=\text{constant}, V_{GS}=0V, V_{DS}=0 \text{ to } 300V$
Output charge	$Q_{oss}$	-	1714	-	nC	$V_{GS}=0V, V_{DS}=0 \text{ to } 300V$
Turn-on delay time	$t_{d(on)}$	-	50	-	ns	$V_{DD}=300V, V_{GS}=13V, I_D=50A, R_G=3\Omega$ ; see table 9
Rise time	$t_r$	-	5	-	ns	$V_{DD}=300V, V_{GS}=13V, I_D=50A, R_G=3\Omega$ ; see table 9
Turn-off delay time	$t_{d(off)}$	-	180	-	ns	$V_{DD}=300V, V_{GS}=13V, I_D=50A, R_G=3\Omega$ ; see table 9
Fall time	$t_f$	-	9	-	ns	$V_{DD}=300V, V_{GS}=13V, I_D=50A, R_G=3\Omega$ ; see table 9

<sup>4)</sup>  $C_{o(er)}$  is a fixed capacitance that gives the same stored energy as  $C_{oss}$  while  $V_{DS}$  is rising from 0 to 300V

<sup>5)</sup>  $C_{o(tr)}$  is a fixed capacitance that gives the same charging time as  $C_{oss}$  while  $V_{DS}$  is rising from 0 to 300V

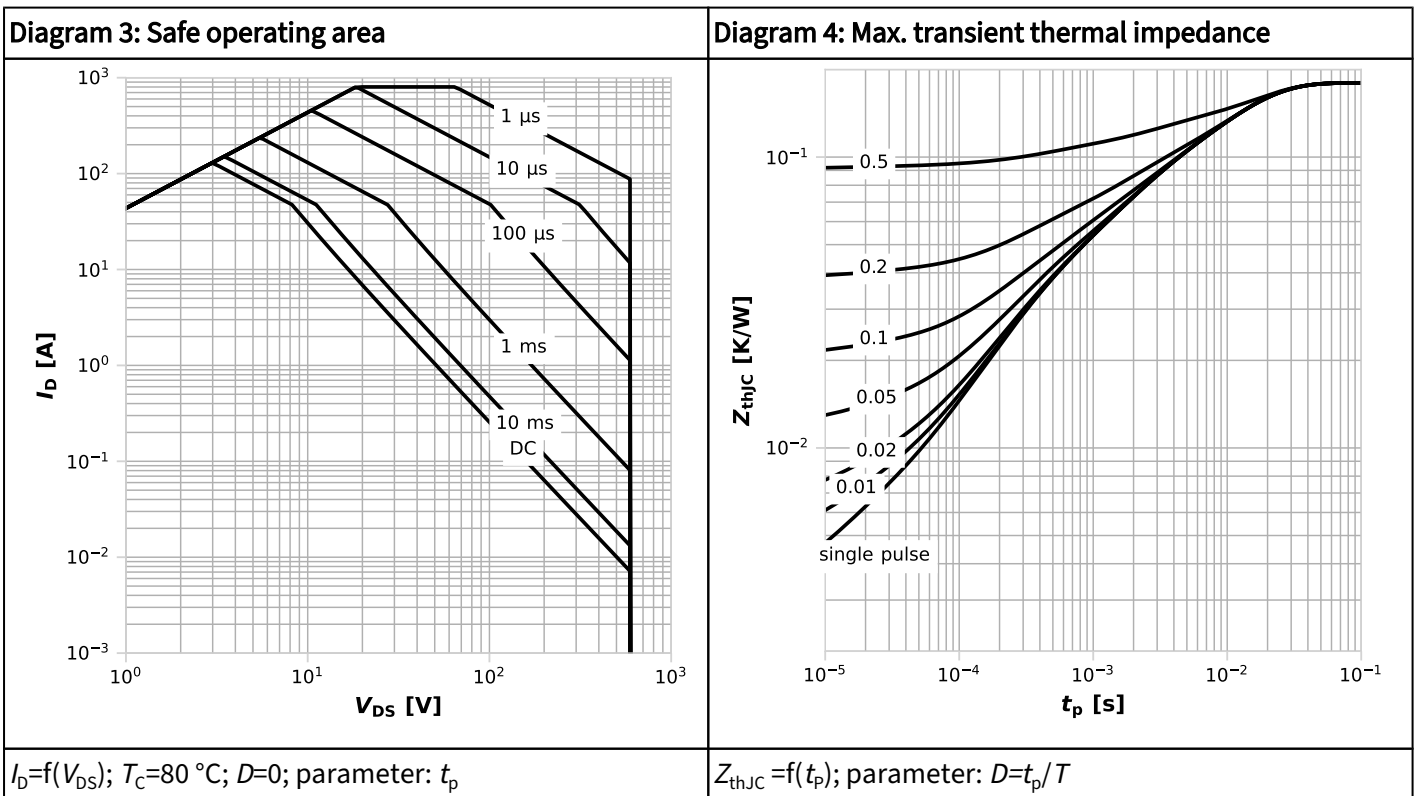
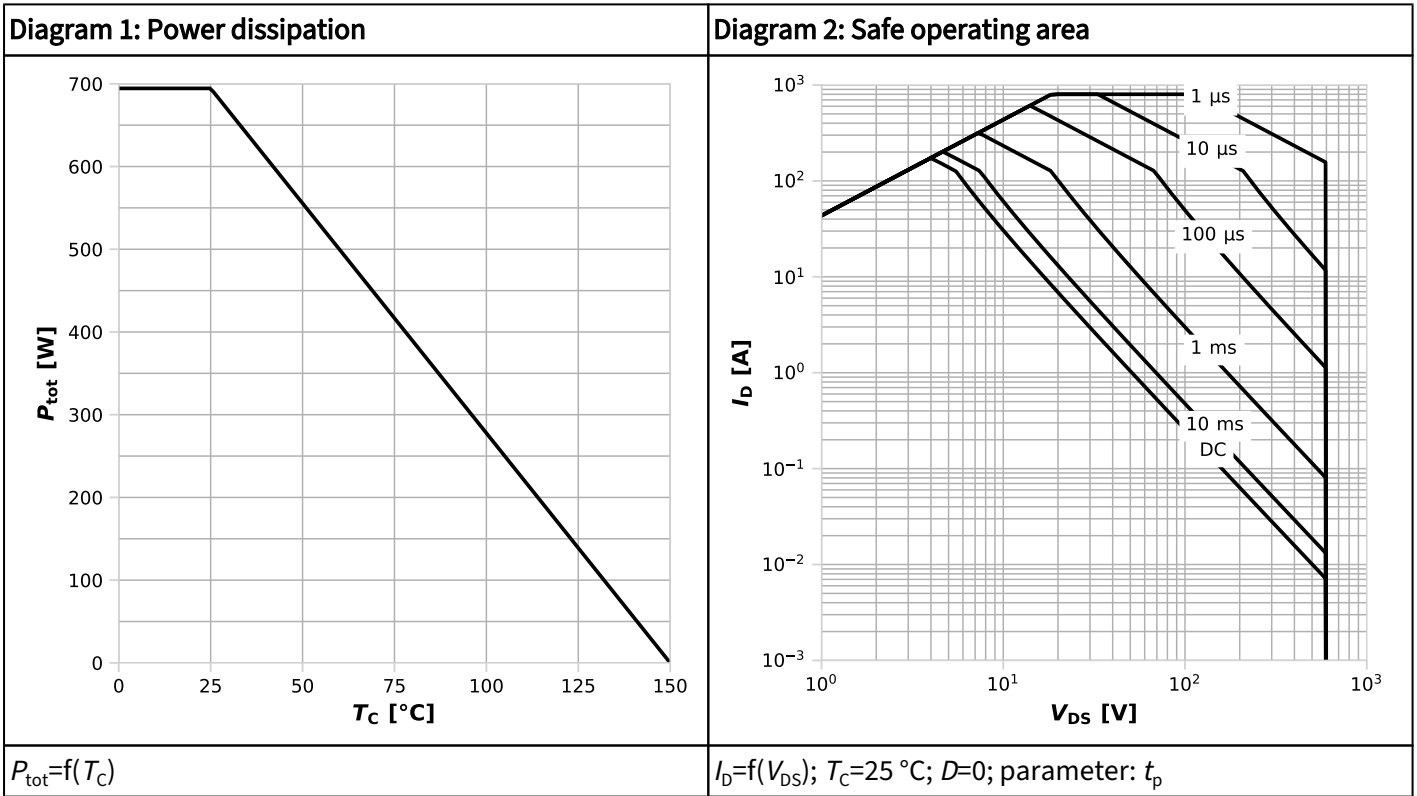
**Table 6 Gate charge characteristics**

Parameter	Symbol	Values			Unit	Note/ Test Condition
		Min.	Typ.	Max.		
Gate to source charge	$Q_{gs}$	-	69	-	nC	$V_{DD}=300V, I_D=50A, V_{GS}=0$ to 12V
Gate to drain charge	$Q_{gd}$	-	105	-	nC	$V_{DD}=300V, I_D=50A, V_{GS}=0$ to 12V
Gate charge total	$Q_g$	-	318	-	nC	$V_{DD}=300V, I_D=50A, V_{GS}=0$ to 12V
Gate plateau voltage	$V_{plateau}$	-	5.7	-	V	$V_{DD}=300V, I_D=50A, V_{GS}=0$ to 12V

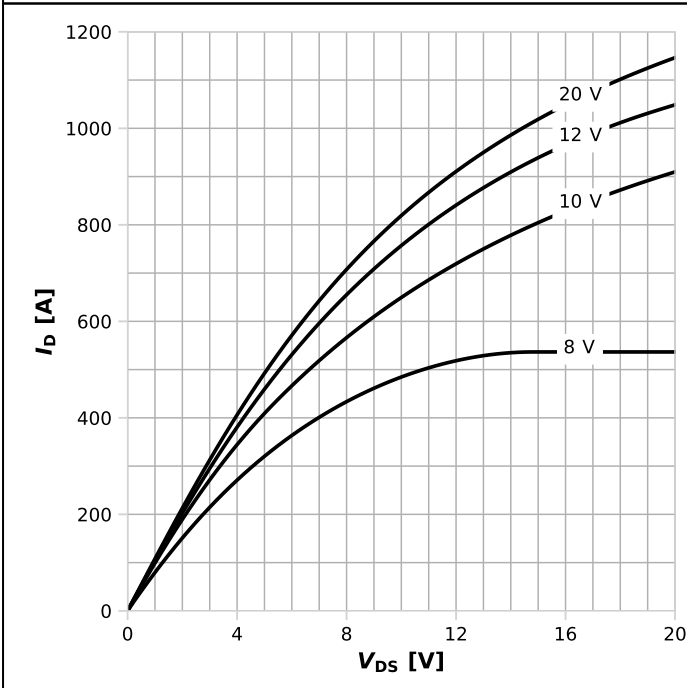
**Table 7 Reverse diode characteristics**

Parameter	Symbol	Values			Unit	Note/ Test Condition
		Min.	Typ.	Max.		
Diode forward voltage	$V_{SD}$	-	0.82	-	V	$V_{GS}=0V, I_F=50A, T_j=25^\circ C$
Reverse recovery time	$t_{rr}$	-	600	-	ns	$V_R=300V, I_F=50A, di_F/dt=100A/\mu s$ ; see table 8
Reverse recovery charge	$Q_{rr}$	-	17	-	$\mu C$	$V_R=300V, I_F=50A, di_F/dt=100A/\mu s$ ; see table 8
Peak reverse recovery current	$I_{rrm}$	-	55	-	A	$V_R=300V, I_F=50A, di_F/dt=100A/\mu s$ ; see table 8

## 4 Electrical characteristics diagrams

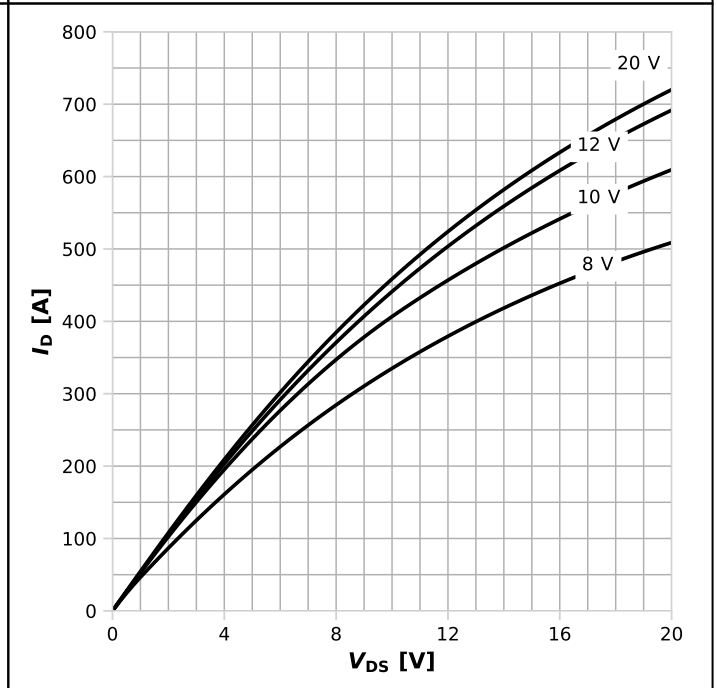


**Diagram 5: Typ. output characteristics**



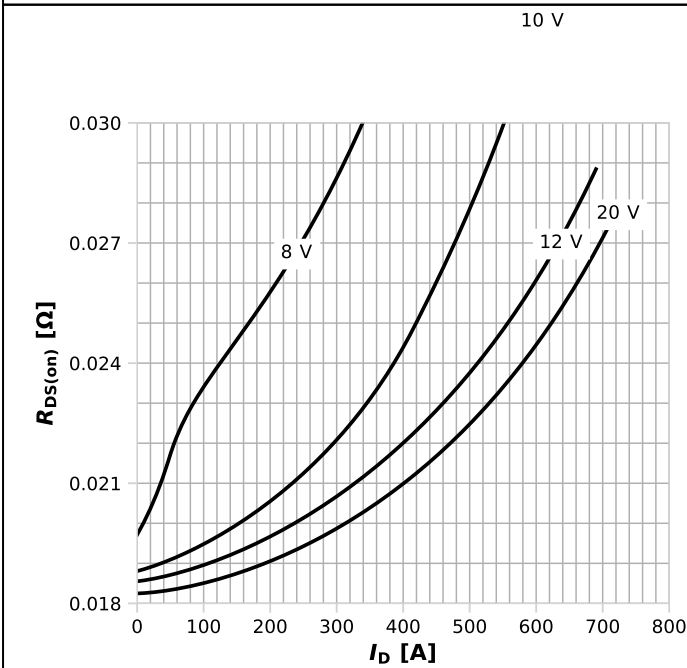
$I_D = f(V_{DS}); T_j = 25\text{ °C}; \text{parameter: } V_{GS}$

**Diagram 6: Typ. output characteristics**



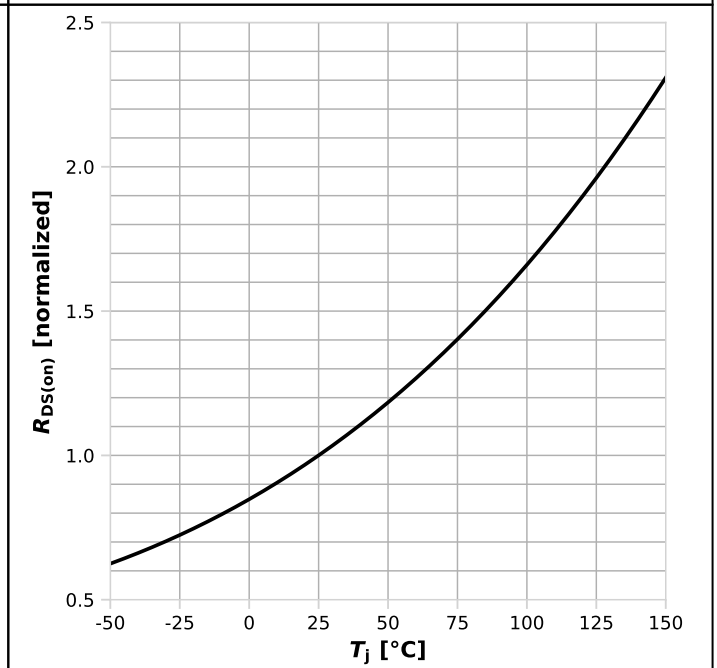
$I_D = f(V_{DS}); T_j = 125\text{ °C}; \text{parameter: } V_{GS}$

**Diagram 7: Typ. drain-source on-state resistance**



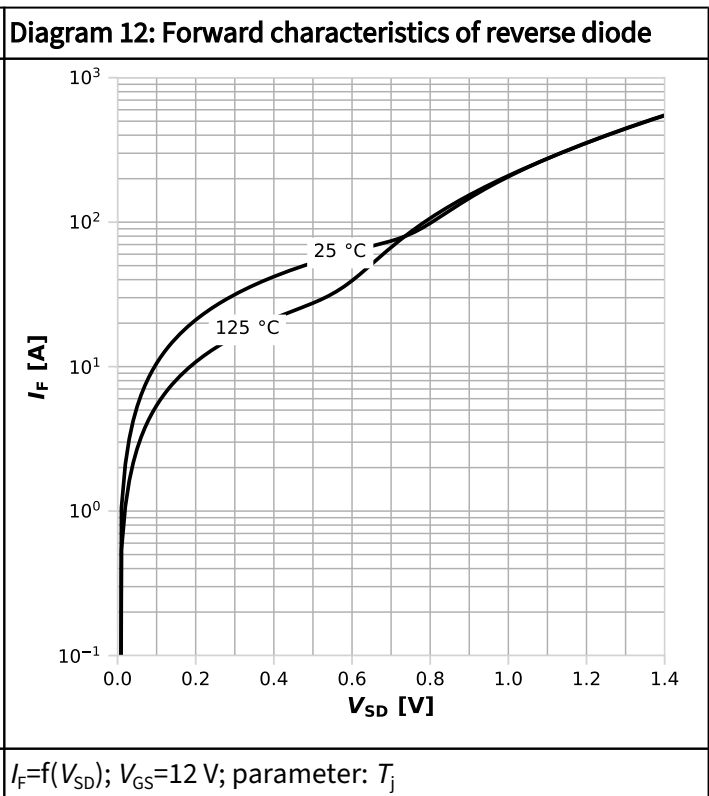
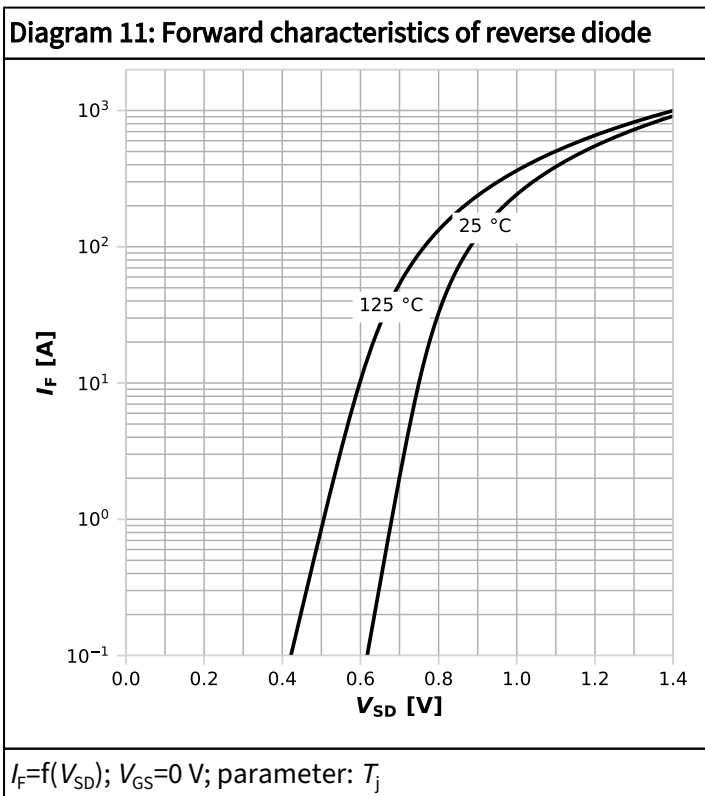
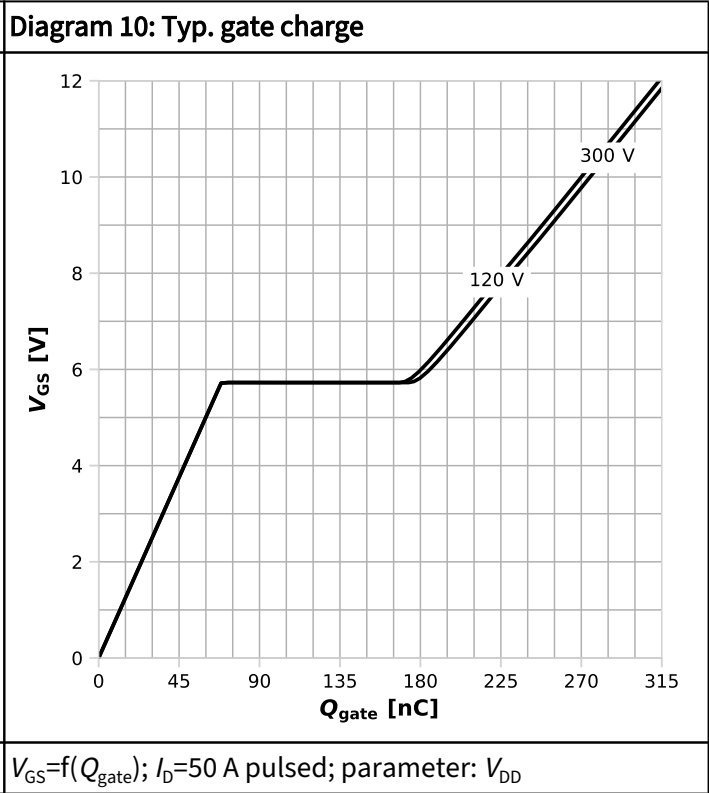
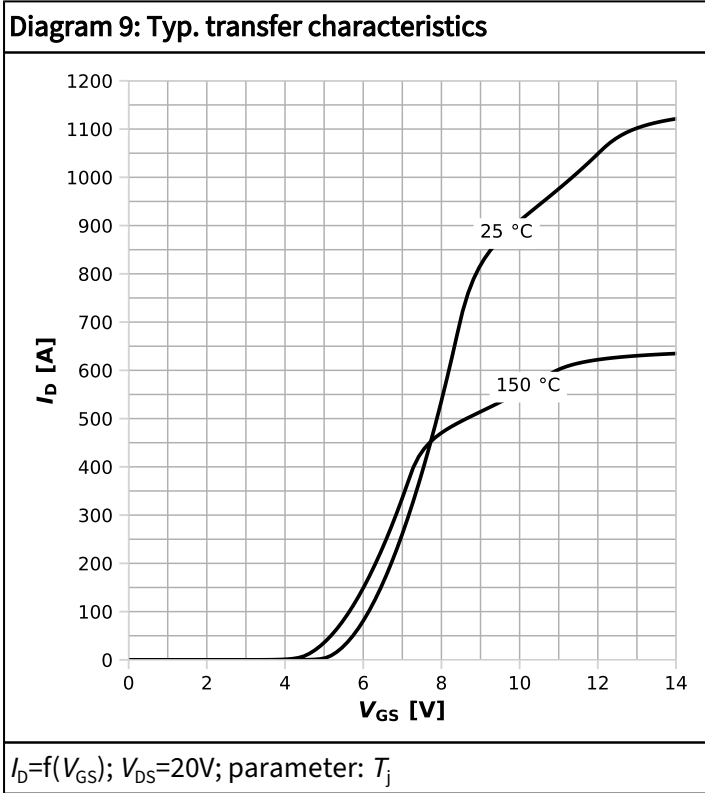
$R_{DS(on)} = f(I_D); T_j = 125\text{ °C}; \text{parameter: } V_{GS}$

**Diagram 8: Drain-source on-state resistance**

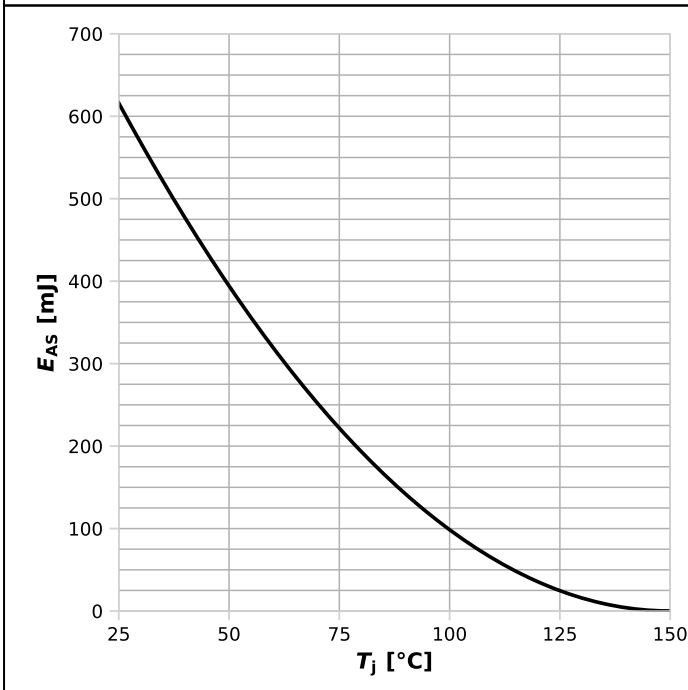


$R_{DS(on)} = f(T_j); I_D = 50\text{ A}; V_{GS} = 12\text{ V}$



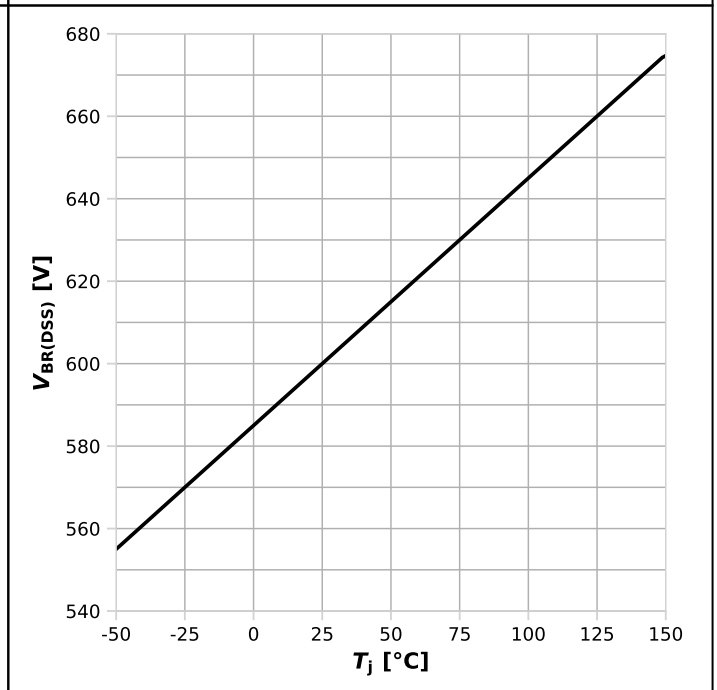


**Diagram 13: Avalanche energy**



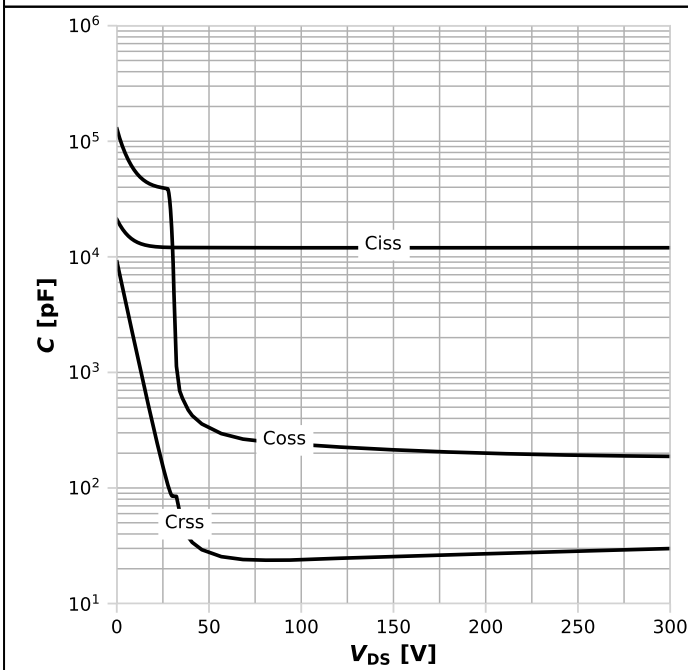
$E_{AS}=f(T_j); I_D=6.3\text{ A}; V_{DD}=50\text{ V}$

**Diagram 14: Drain-source breakdown voltage**



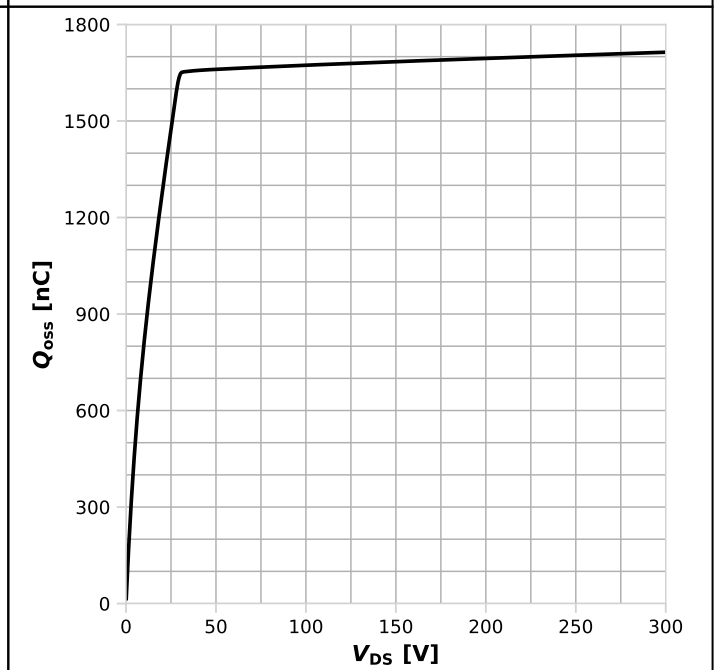
$V_{BR(DSS)}=f(T_j); I_D=1\text{ mA}$

**Diagram 15: Typ. capacitances**



$C=f(V_{DS}); V_{GS}=0\text{ V}; f=250\text{ kHz}$

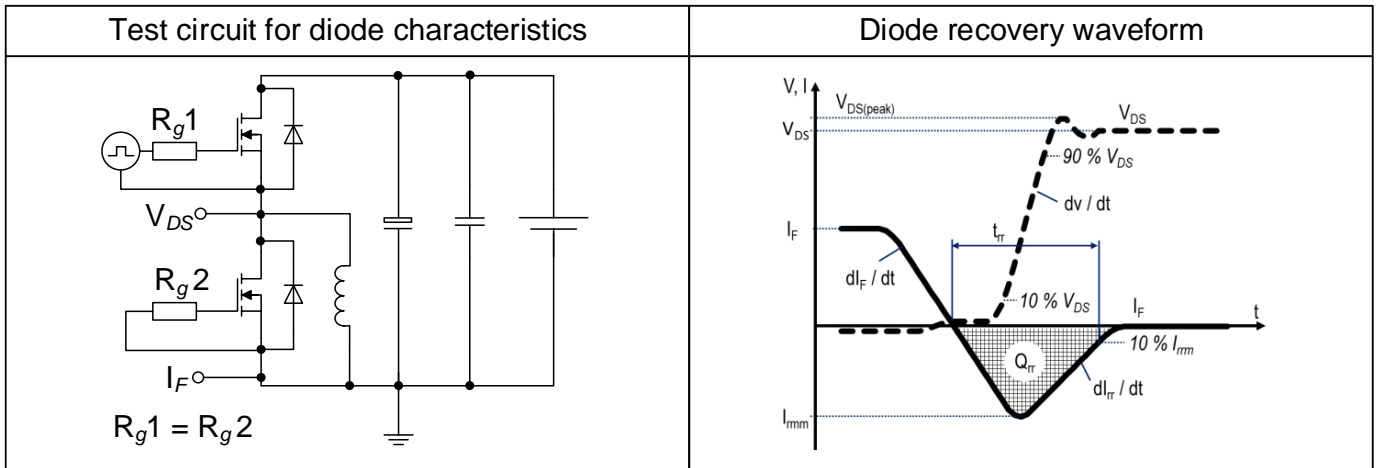
**Diagram 17: Typ. Q\_oss output charge**



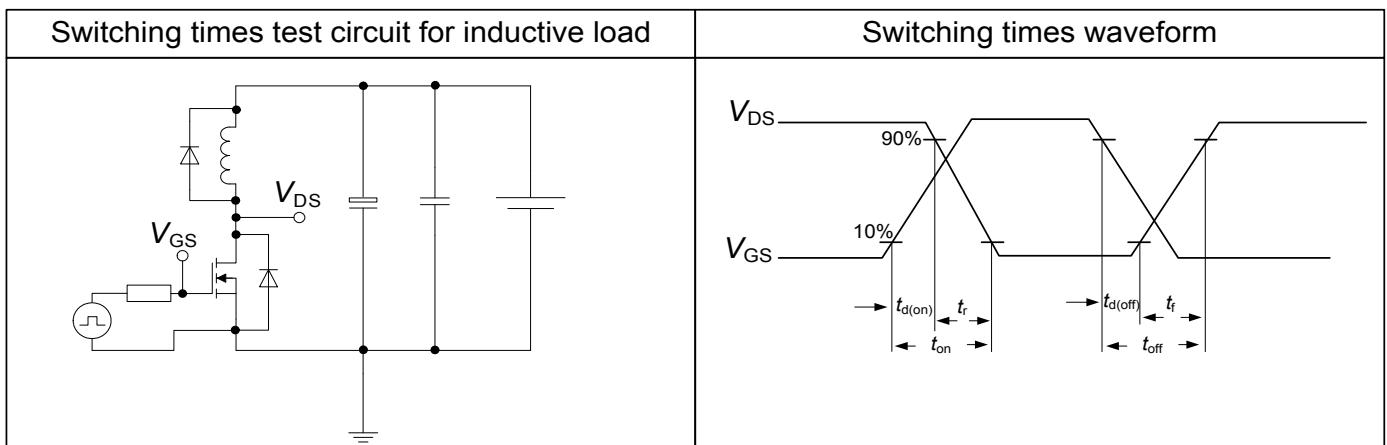
$Q_{oss}=f(V_{DS}); V_{GS}=0\text{ V}$

## 5 Test Circuits

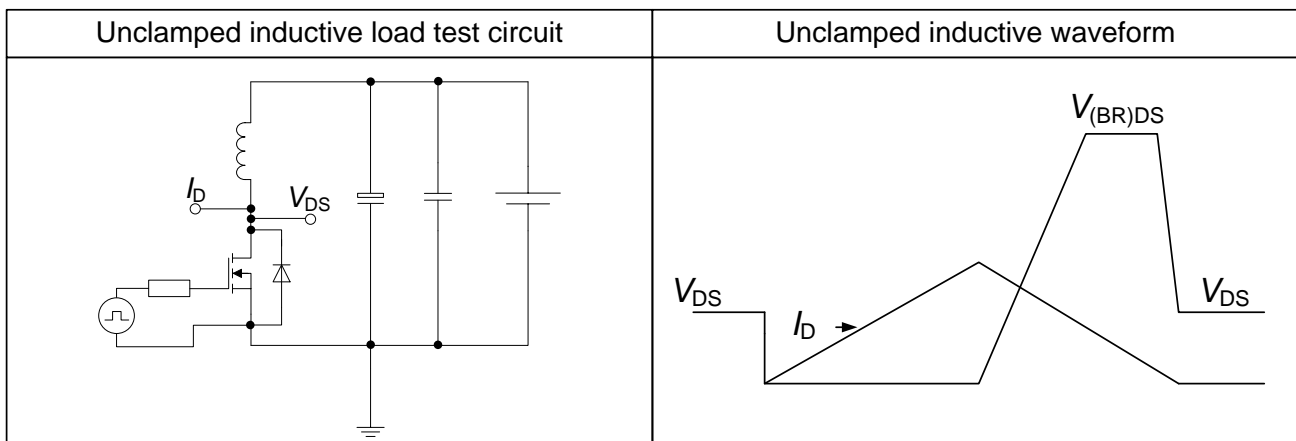
**Table 8 Diode characteristics**



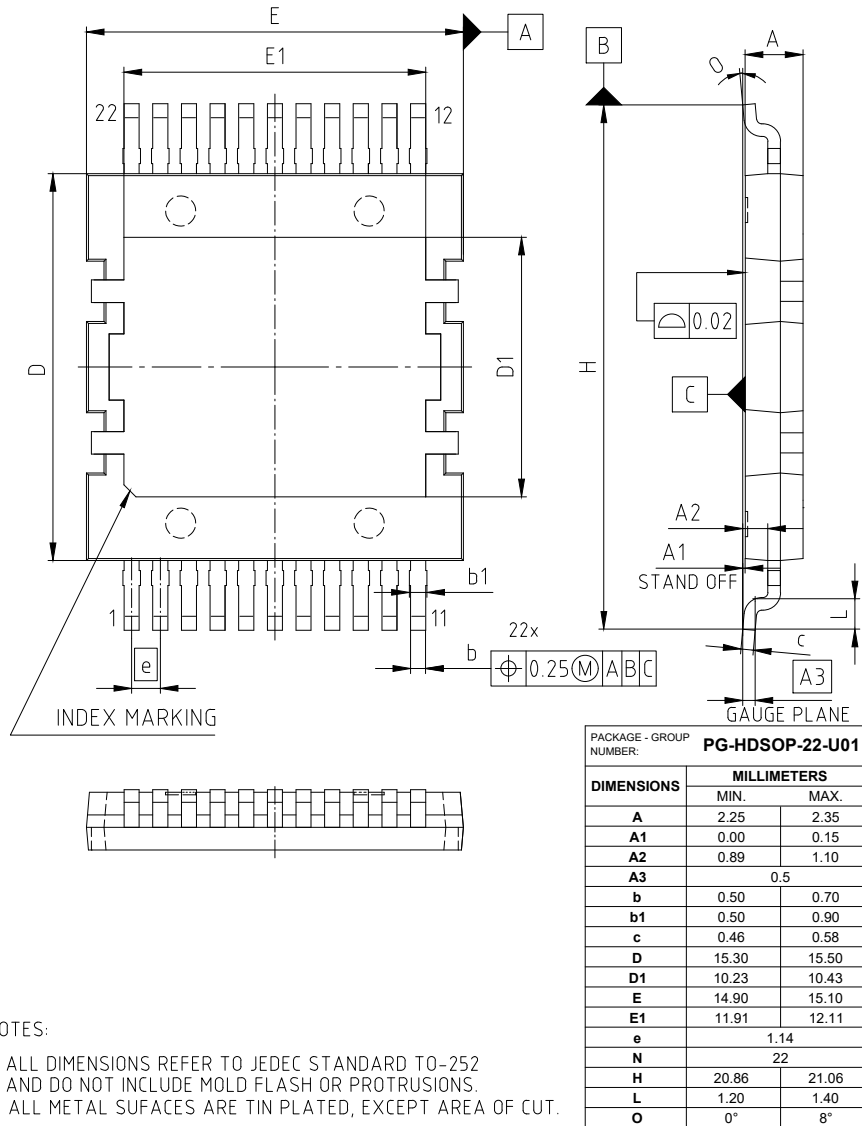
**Table 9 Switching times (ss)**



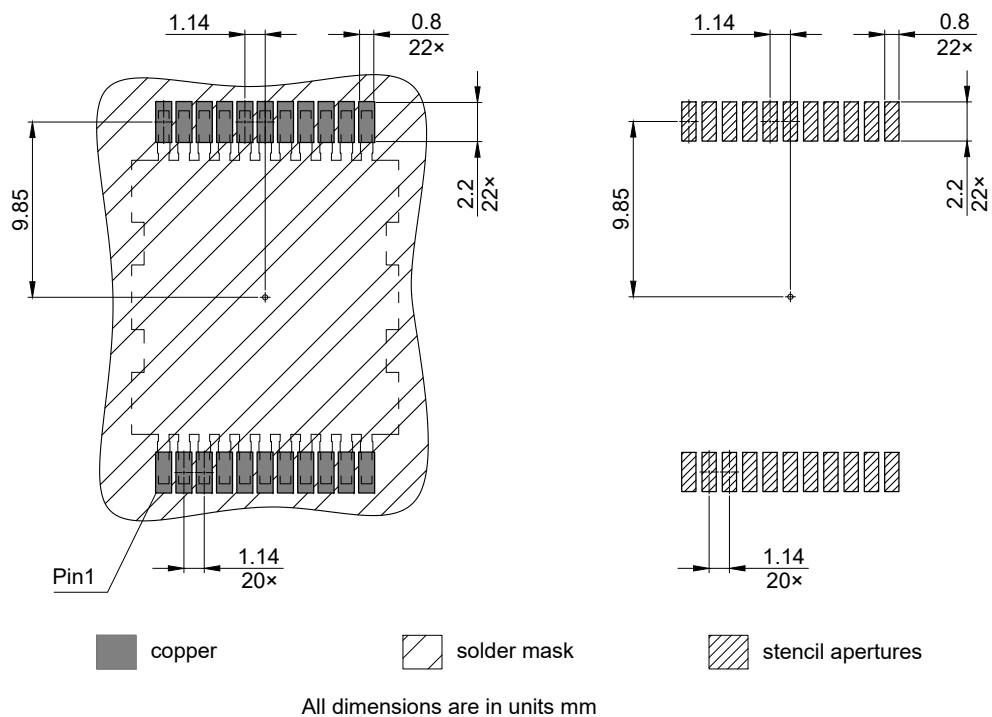
**Table 10 Unclamped inductive load (ss)**



## 6 Package Outlines



**Figure 1 Outline PG-HDSOP-22, dimensions in mm**



**Figure 2 Outline PG-HDSOP-22, dimensions in mm**

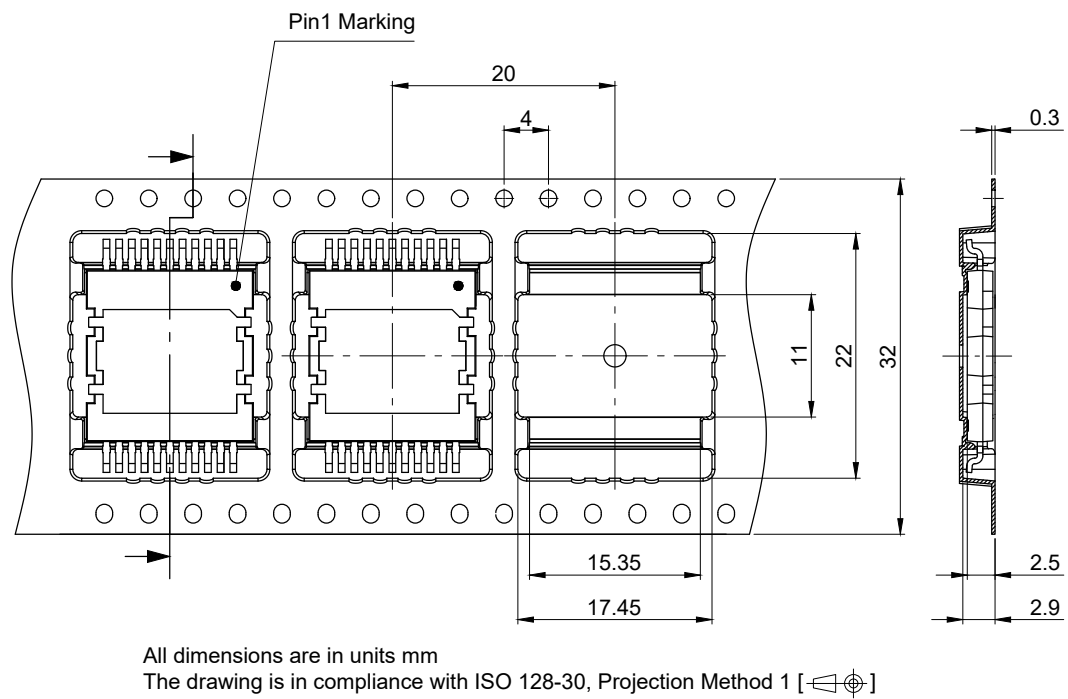


Figure 3 Outline PG-HDSOP-22, dimensions in mm

## 7 Appendix A

Table 11 Related Links

- [IFX CoolMOS S7 Webpage](#)
- [IFX CoolMOS S7 application note](#)
- [IFX CoolMOS S7 simulation model](#)
- [IFX Design tools](#)

## Revision History

IPDQ60R010S7

### Revision 2024-05-24, Rev. 2.4

Previous Revision

Revision	Date	Subjects (major changes since last revision)
2.0	2020-06-29	Release of final version
2.1	2021-10-25	Change of wording regarding breakdown voltage / cosmic ray
2.2	2023-11-06	Added footmark for pulsed drain current
2.3	2023-11-22	Additional maximum parameter for high current turn off added to datasheet for SSCB, SSR and motor start applications; Removed footmark from pulsed drain current
2.4	2024-05-24	Removed high current turn-off parameter limitation, Adaption of Transfer curve, Output characteristics and drain-source on-state resistance

#### Trademarks

All referenced product or service names and trademarks are the property of their respective owners.

**We Listen to Your Comments** Any information within this document that you feel is wrong, unclear or missing at all? Your feedback will help us to continuously improve the quality of this document. Please send your proposal (including a reference to this document) to: [erratum@infineon.com](mailto:erratum@infineon.com)

#### Published by

Infineon Technologies AG  
81726 München, Germany  
© 2024 Infineon Technologies AG  
All Rights Reserved.

#### Legal Disclaimer

The information given in this document shall in no event be regarded as a guarantee of conditions or characteristics ("Beschaffenheitsgarantie"). With respect to any examples, hints or any typical values stated herein and/or any information regarding the application of the product, Infineon Technologies hereby disclaims any and all warranties and liabilities of any kind, including without limitation warranties of non-infringement of intellectual property rights of any third party.

In addition, any information given in this document is subject to customer's compliance with its obligations stated in this document and any applicable legal requirements, norms and standards concerning customer's products and any use of the product of Infineon Technologies in customer's applications.

The data contained in this document is exclusively intended for technically trained staff. It is the responsibility of customer's technical departments to evaluate the suitability of the product for the intended application and the completeness of the product information given in this document with respect to such application.

#### Information

For further information on technology, delivery terms and conditions and prices please contact your nearest Infineon Technologies Office ([www.infineon.com](http://www.infineon.com)).

#### Warnings

Due to technical requirements, components may contain dangerous substances. For information on the types in question, please contact the nearest Infineon Technologies Office.

The Infineon Technologies component described in this Data Sheet may be used in life-support devices or systems and/or automotive, aviation and aerospace applications or systems only with the express written approval of Infineon Technologies, if a failure of such components can reasonably be expected to cause the failure of that life-support, automotive, aviation and aerospace device or system or to affect the safety or effectiveness of that device or system. Life support devices or systems are intended to be implanted in the human body or to support and/or



**Public**

# 600V CoolMOS™ SJ S7 Power Device

## IPDQ60R010S7

---



maintain and sustain and/or protect human life. If they fail, it is reasonable to assume that the health of the user or other persons may be endangered.