

**HEXFET® POWER MOSFET
SURFACE MOUNT (SMD-0.5)**

150V, P-CHANNEL

Product Summary

| Part Number | BV_{DSS} | $R_{DS(on)}$ | I_D |
|-------------|------------|--------------|-------|
| IRF5NJ6215 | -150V | 0.29Ω | -11A |

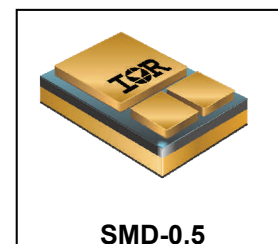

Description

Fifth Generation HEXFET® power MOSFETs from IR HiRel utilize advanced processing techniques to achieve the lowest possible on-resistance per silicon unit area. This benefit, combined with the fast switching speed and ruggedized device design that HEXFET power MOSFETs are well known for, provides the designer with an extremely efficient device for use in a wide variety of applications.

These devices are well-suited for applications such as switching power supplies, motor controls, inverters, choppers, audio amplifiers and high-energy pulse circuits.

Features

- Low $R_{DS(on)}$
- Avalanche Energy Ratings
- Dynamic dv/dt Rating
- Simple Drive Requirements
- Hermetically Sealed
- Surface Mount
- Light Weight

Absolute Maximum Ratings

Pre-Irradiation

| Symbol | Parameter | Value | Units |
|---|---|---------------|-------|
| $I_{D1} @ V_{GS} = -10V, T_C = 25^\circ C$ | Continuous Drain Current | -11 | A |
| $I_{D2} @ V_{GS} = -10V, T_C = 100^\circ C$ | Continuous Drain Current | -7.2 | |
| $I_{DM} @ T_C = 25^\circ C$ | Pulsed Drain Current ① | -44 | |
| $P_D @ T_C = 25^\circ C$ | Maximum Power Dissipation | 75 | W |
| | Linear Derating Factor | 0.6 | W/°C |
| V_{GS} | Gate-to-Source Voltage | ±20 | V |
| E_{AS} | Single Pulse Avalanche Energy ② | 130 | mJ |
| I_{AR} | Avalanche Current ① | -11 | A |
| E_{AR} | Repetitive Avalanche Energy ① | 7.5 | mJ |
| dv/dt | Peak Diode Recovery dv/dt ③ | 10 | V/ns |
| T_J T_{STG} | Operating Junction and Storage Temperature Range | -55 to + 150 | °C |
| | Package Mounting Surface Temp | 300 (for 5s) | |
| | Weight | 1.0 (Typical) | g |

For Footnotes, refer to the page 2.

Electrical Characteristics @ T_j = 25°C (Unless Otherwise Specified)

| Symbol | Parameter | Min. | Typ. | Max. | Units | Test Conditions |
|-------------------------------------|--------------------------------------|------|-------|------|-------|---|
| BV _{DSS} | Drain-to-Source Breakdown Voltage | -150 | — | — | V | V _{GS} = 0V, I _D = -250μA |
| ΔBV _{DSS} /ΔT _J | Breakdown Voltage Temp. Coefficient | — | -0.17 | — | V/°C | Reference to 25°C, I _D = -1.0mA |
| R _{DS(on)} | Static Drain-to-Source On-Resistance | — | — | 0.29 | Ω | V _{GS} = -10V, I _{D2} = -7.2A ④ |
| V _{GS(th)} | Gate Threshold Voltage | -2.0 | — | -4.0 | V | V _{DS} = V _{GS} , I _D = -250μA |
| g _{fs} | Forward Transconductance | 2.3 | — | — | S | V _{DS} = -25V, I _{D2} = -7.2A ④ |
| I _{DSS} | Zero Gate Voltage Drain Current | — | — | -25 | μA | V _{DS} = -120V, V _{GS} = 0V |
| | | — | — | -250 | | V _{DS} = -120V, V _{GS} = 0V, T _J = 125°C |
| I _{GSS} | Gate-to-Source Leakage Forward | — | — | -100 | nA | V _{GS} = -20V |
| | Gate-to-Source Leakage Reverse | — | — | 100 | | V _{GS} = 20V |
| Q _G | Total Gate Charge | — | — | 66 | nC | I _{D2} = -7.2A |
| Q _{GS} | Gate-to-Source Charge | — | — | 13 | | V _{DS} = -120V |
| Q _{GD} | Gate-to-Drain ('Miller') Charge | — | — | 40 | | V _{GS} = -10V |
| t _{d(on)} | Turn-On Delay Time | — | — | 25 | ns | V _{DD} = -75V |
| t _r | Rise Time | — | — | 65 | | I _{D2} = -7.2A |
| t _{d(off)} | Turn-Off Delay Time | — | — | 75 | | R _G = 6.8Ω |
| t _f | Fall Time | — | — | 53 | | V _{GS} = -10V |
| L _S + L _D | Total Inductance | — | 4.0 | — | nH | Measured from center of Drain pad to center of Source pad |
| C _{iss} | Input Capacitance | — | 990 | — | pF | V _{GS} = 0V |
| C _{oss} | Output Capacitance | — | 230 | — | | V _{DS} = -25V |
| C _{rss} | Reverse Transfer Capacitance | — | 120 | — | | f = 1.0MHz |

Source-Drain Diode Ratings and Characteristics

| Symbol | Parameter | Min. | Typ. | Max. | Units | Test Conditions |
|-----------------|--|---|------|------|-------|---|
| I _S | Continuous Source Current (Body Diode) | — | — | -11 | A | |
| I _{SM} | Pulsed Source Current (Body Diode) ① | — | — | -44 | | |
| V _{SD} | Diode Forward Voltage | — | — | -1.6 | V | T _J = 25°C, I _S = -7.2A, V _{GS} = 0V ④ |
| t _{rr} | Reverse Recovery Time | — | — | 240 | ns | T _J = 25°C, I _F = -7.2A, V _{DD} ≤ -25V |
| Q _{rr} | Reverse Recovery Charge | — | — | 1.7 | μC | di/dt = -100A/μs ④ |
| t _{on} | Forward Turn-On Time | Intrinsic turn-on time is negligible (turn-on is dominated by L _S + L _D) | | | | |

Thermal Resistance

| Symbol | Parameter | Min. | Typ. | Max. | Units |
|------------------|------------------|------|------|------|-------|
| R _{θJC} | Junction-to-Case | — | — | 1.67 | °C/W |

Footnotes:

- ① Repetitive Rating; Pulse width limited by maximum junction temperature.
- ② V_{DD} = -50V, starting T_J = 25°C, L = 5.0mH, Peak I_L = -7.2A, V_{GS} = -10V, R_G = 25Ω
- ③ I_{SD} ≤ -7.2A, di/dt ≤ -390A/μs, V_{DD} ≤ -150V, T_J ≤ 150°C
- ④ Pulse width ≤ 300 μs; Duty Cycle ≤ 2%

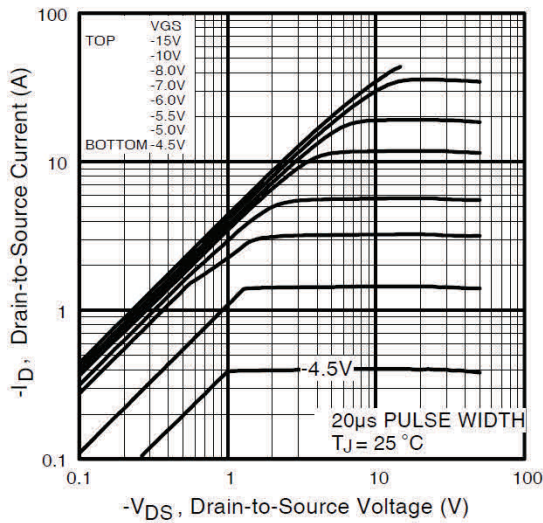

Fig 1. Typical Output Characteristics

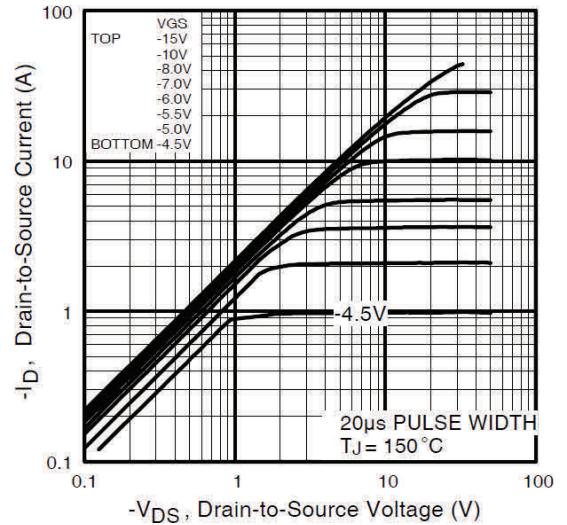

Fig 2. Typical Output Characteristics

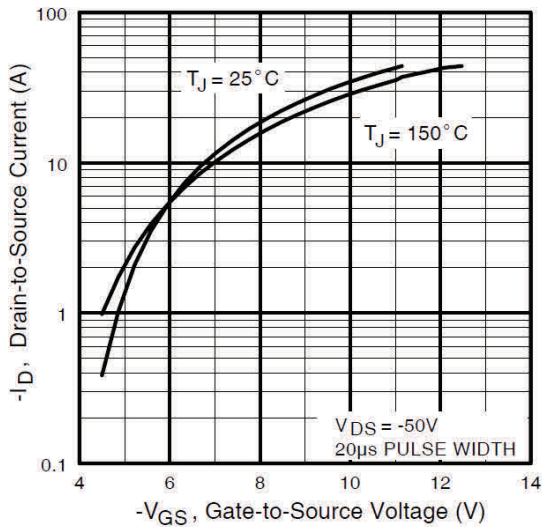

Fig 3. Typical Transfer Characteristics

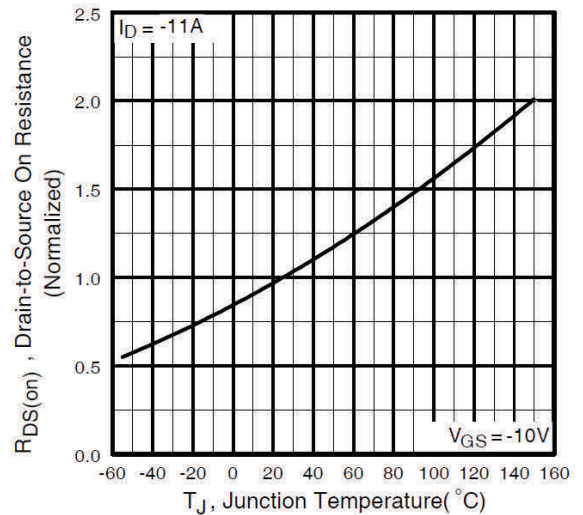

Fig 4. Normalized On-Resistance Vs. Temperature

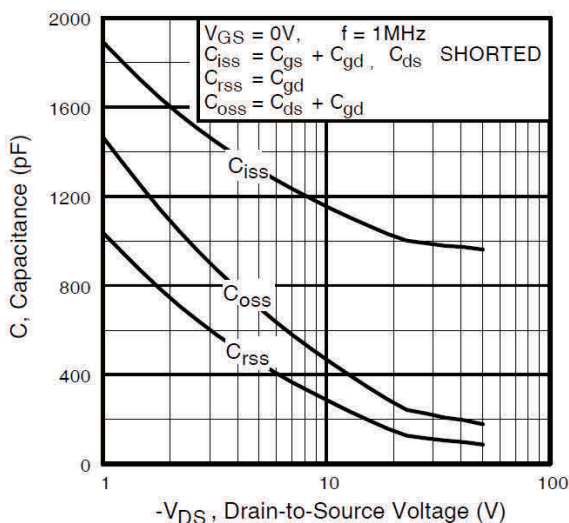

Fig 5. Typical Capacitance Vs. Drain-to-Source Voltage

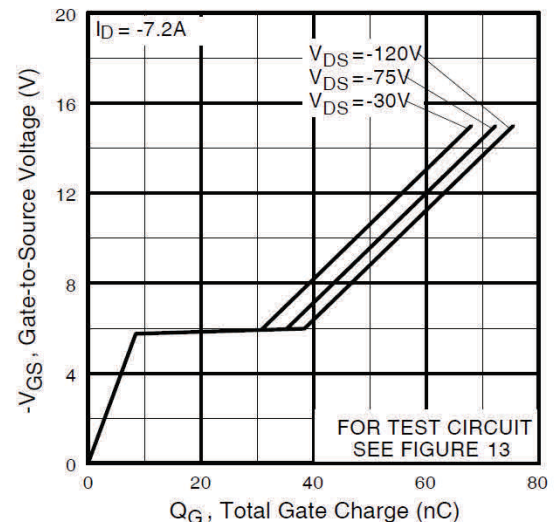

Fig 6. Typical Gate Charge Vs. Gate-to-Source Voltage

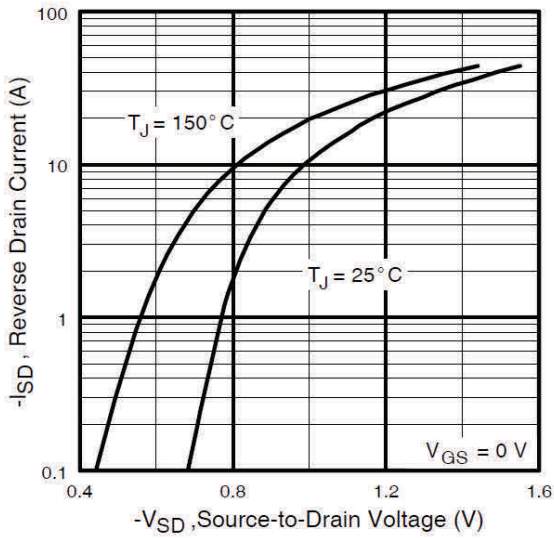

Fig 7. Typical Source-Drain Diode Forward Voltage

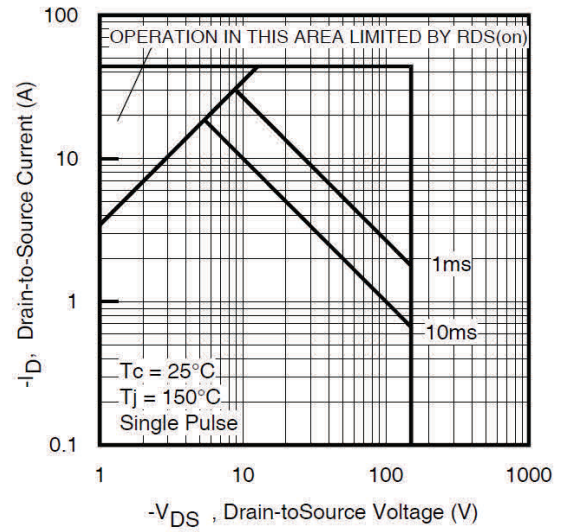

Fig 8. Maximum Safe Operating Area

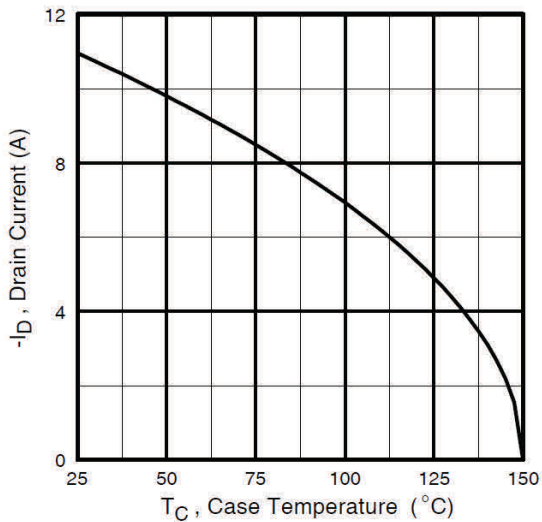

Fig 9. Maximum Drain Current Vs. Case Temperature

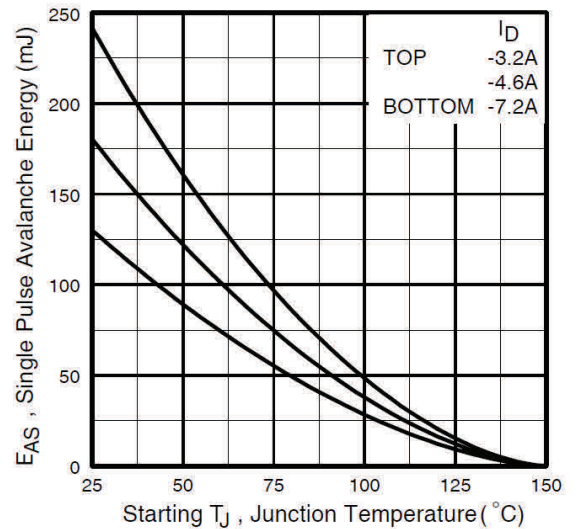

Fig 10. Maximum Avalanche Energy Vs. Drain Current

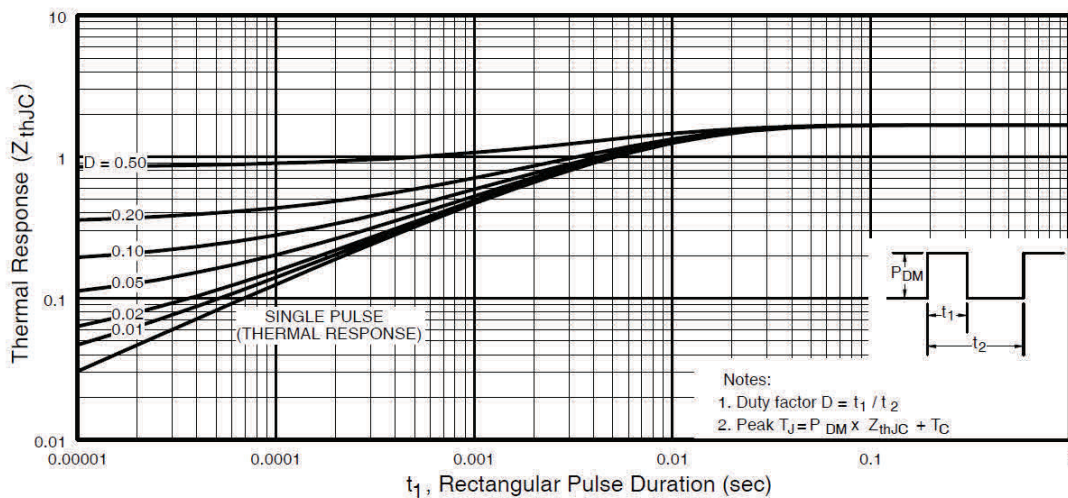

Fig 11. Maximum Effective Transient Thermal Impedance, Junction-to-Case

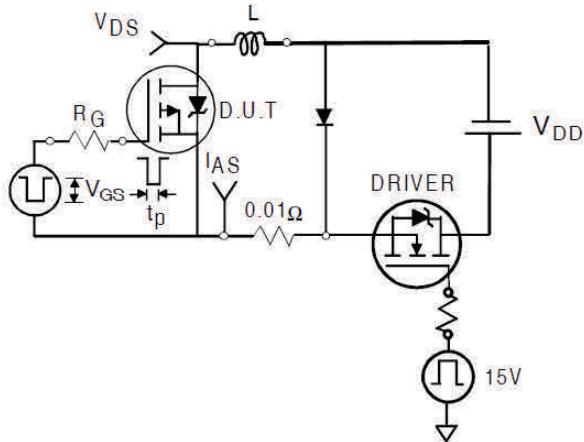

Fig 12a. Unclamped Inductive Test Circuit

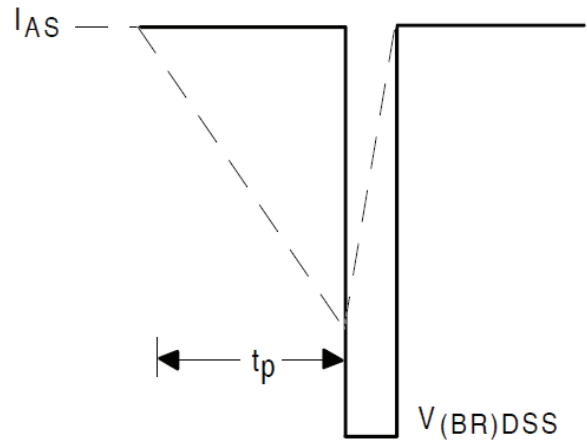

Fig 12b. Unclamped Inductive Waveforms

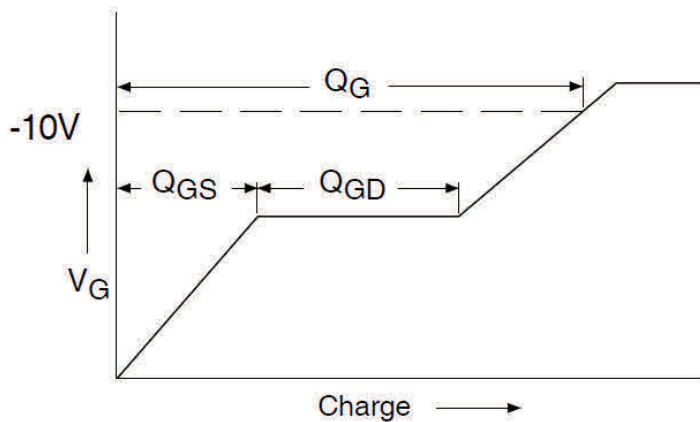

Fig 13a. Gate Charge Waveform

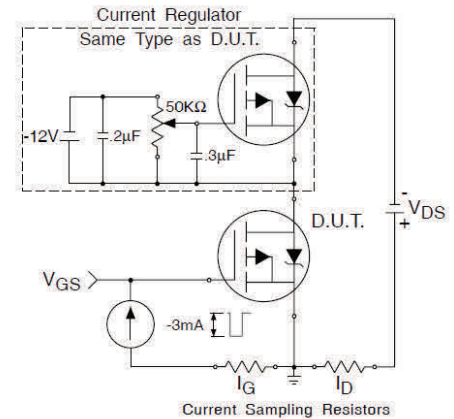

Fig 13b. Gate Charge Test Circuit

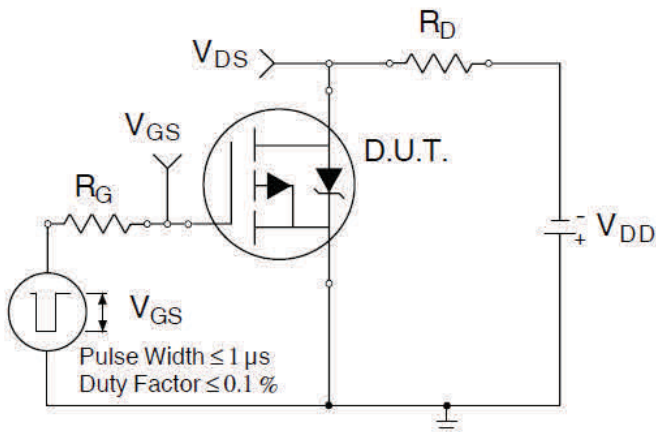

Fig 14a. Switching Time Test Circuit

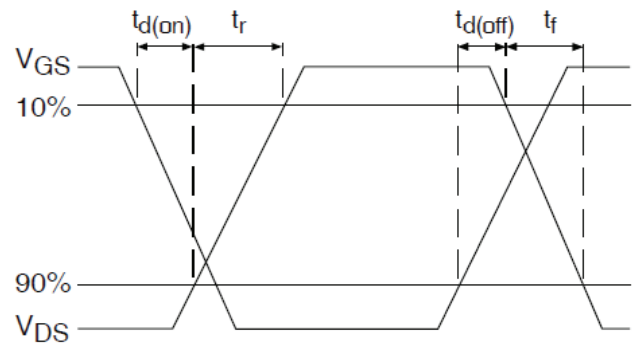
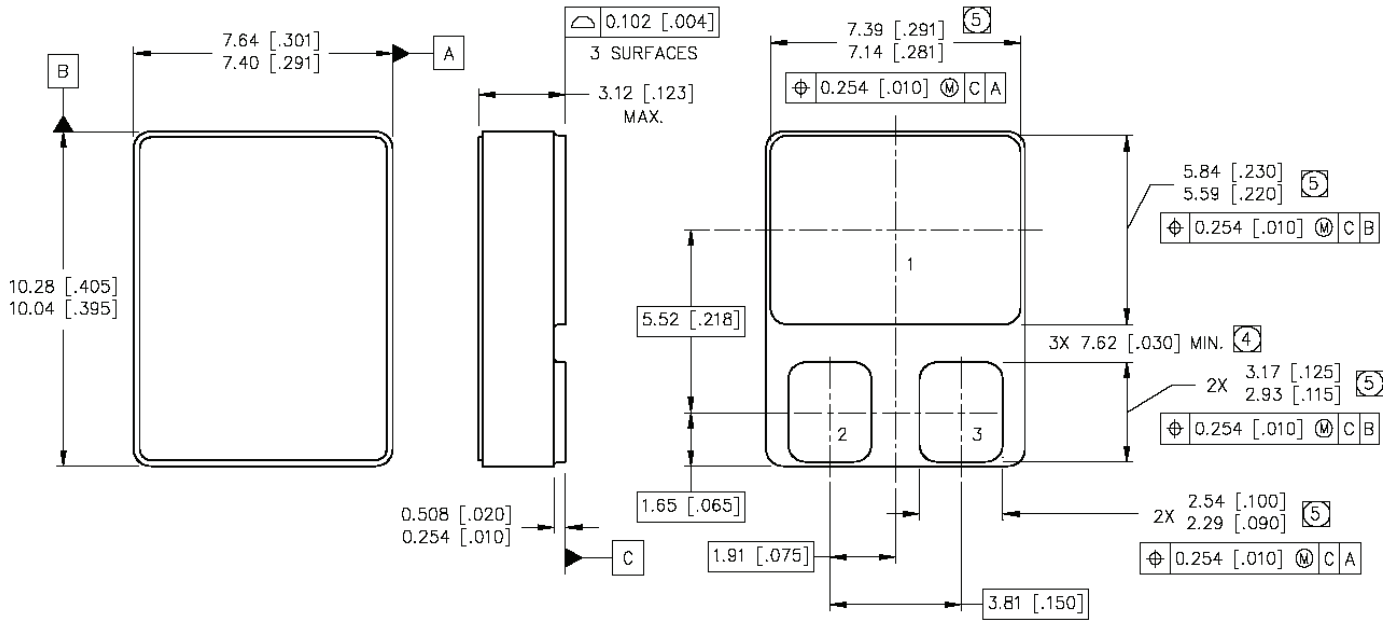

Fig 14b. Switching Time Waveforms

Case Outline and Dimensions — SMD-0.5



NOTES:

1. DIMENSIONING & TOLERANCING PER ASME Y14.5M-1994.
2. CONTROLLING DIMENSION: INCH.
3. DIMENSIONS ARE SHOWN IN MILLIMETERS [INCHES].
- ④ DIMENSION INCLUDES METALLIZATION FLASH.
- ⑤ DIMENSION DOES NOT INCLUDE METALLIZATION FLASH.

PAD ASSIGNMENTS

- 1 = DRAIN
- 2 = GATE
- 3 = SOURCE

IMPORTANT NOTICE

The information given in this document shall be in no event regarded as guarantee of conditions or characteristic. The data contained herein is a characterization of the component based on internal standards and is intended to demonstrate and provide guidance for typical part performance. It will require further evaluation, qualification and analysis to determine suitability in the application environment to confirm compliance to your system requirements.

With respect to any example hints or any typical values stated herein and/or any information regarding the application of the product, Infineon Technologies hereby disclaims any and all warranties and liabilities of any kind including without limitation warranties on non- infringement of intellectual property rights and any third party.

In addition, any information given in this document is subject to customer's compliance with its obligations stated in this document and any applicable legal requirements, norms and standards concerning customer's product and any use of the product of Infineon Technologies in customer's applications.

The data contained in this document is exclusively intended for technically trained staff. It is the responsibility of any customer's technical departments to evaluate the suitability of the product for the intended applications and the completeness of the product information given in this document with respect to applications.

For further information on the product, technology, delivery terms and conditions and prices, please contact your local sales representative or go to (www.infineon.com/hirel).

WARNING

Due to technical requirements products may contain dangerous substances. For information on the types in question, please contact your nearest Infineon Technologies office.