

OPTIREG™ linear voltage regulator TLS115B0EJ

High-precision voltage tracker



Order now



Technical documents



Simulation



Family overview



Support



Features

- 150 mA current capability
- Very high tracking accuracy
- Output voltage adjustable down to 2.0 V
- Stable with ceramic output capacitors
- Very low dropout voltage of typically 250 mV at 150 mA
- Very low current consumption of typically 0.1 μ A in standby mode
- Internally controlled soft start
- Wide input voltage range: $-16\text{ V} \leq V_{\text{IN}} \leq 45\text{ V}$
- Wide temperature range: $-40^\circ\text{C} \leq T_j \leq 150^\circ\text{C}$
- Short circuit protected output (to GND and to battery)
- Reverse polarity protected input
- Overtemperature protection
- Green Product (RoHS compliant)

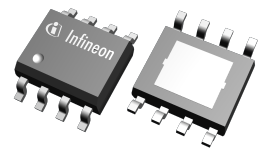

Potential applications

- Automotive sensor supply
- Protected sensor supply for off-board sensors
- Secondary voltage supply in automotive ECU
- High precision voltage tracking
- Precision voltage replication
- Power switch for off-board load

Product validation

Qualified for automotive applications. Product validation according to AEC-Q100.

Description

The OPTIREG™ linear voltage regulator TLS115B0EJ is a monolithic, integrated low-dropout voltage tracking regulator with high accuracy in a small PG-DSO-8 package. The TLS115B0EJ is designed to supply off-board systems, for example sensors in powertrain management systems under the severe conditions of automotive applications. The TLS115B0EJ provides protection functions against reverse polarity as well as against short circuit to GND and to battery. The output voltage follows the reference voltage that is applied to the ADJ input with very high accuracy up to a supply voltage of 45 V and up to an output current of 150 mA. The required minimum reference voltage at ADJ is 2.0 V.

OPTIREG™ linear voltage regulator TLS115B0EJ

High-precision voltage tracker



Description

Type	Package	Marking
TLS115B0EJ	PG-DSO-8	115B0

Table of contents

	Features	1
	Potential applications	1
	Product validation	1
	Description	1
	Table of contents	3
1	Block diagram	5
2	Pin configuration	6
2.1	Pin assignment	6
2.2	Pin definitions and functions	6
3	General product characteristics	7
3.1	Absolute maximum ratings	7
3.2	Functional range	8
3.3	Thermal resistance	8
4	Block description and electrical characteristics	10
4.1	Functional description tracking regulator	10
4.2	Electrical characteristics tracking regulator	11
4.3	Typical performance characteristics tracking regulator	13
4.4	Electrical characteristics current consumption	16
4.5	Typical performance characteristics current consumption	17
4.6	Functional description enable input	19
4.7	Electrical characteristics enable input	19
4.8	Typical performance characteristics enable input	20
4.9	Functional description adjust input	21
4.10	Electrical characteristics adjust input	21
4.11	Typical performance characteristics adjust input	22
5	Application information	23
5.1	Application diagram	23
5.2	Selection of external components	23
5.2.1	Input pin	23
5.2.2	Output pin	24
5.2.3	Adjust pin	24
5.3	Thermal considerations	24
5.4	Further application information	25
6	Package information	26
	Revision history	27

Disclaimer 28

1 Block diagram

1 Block diagram

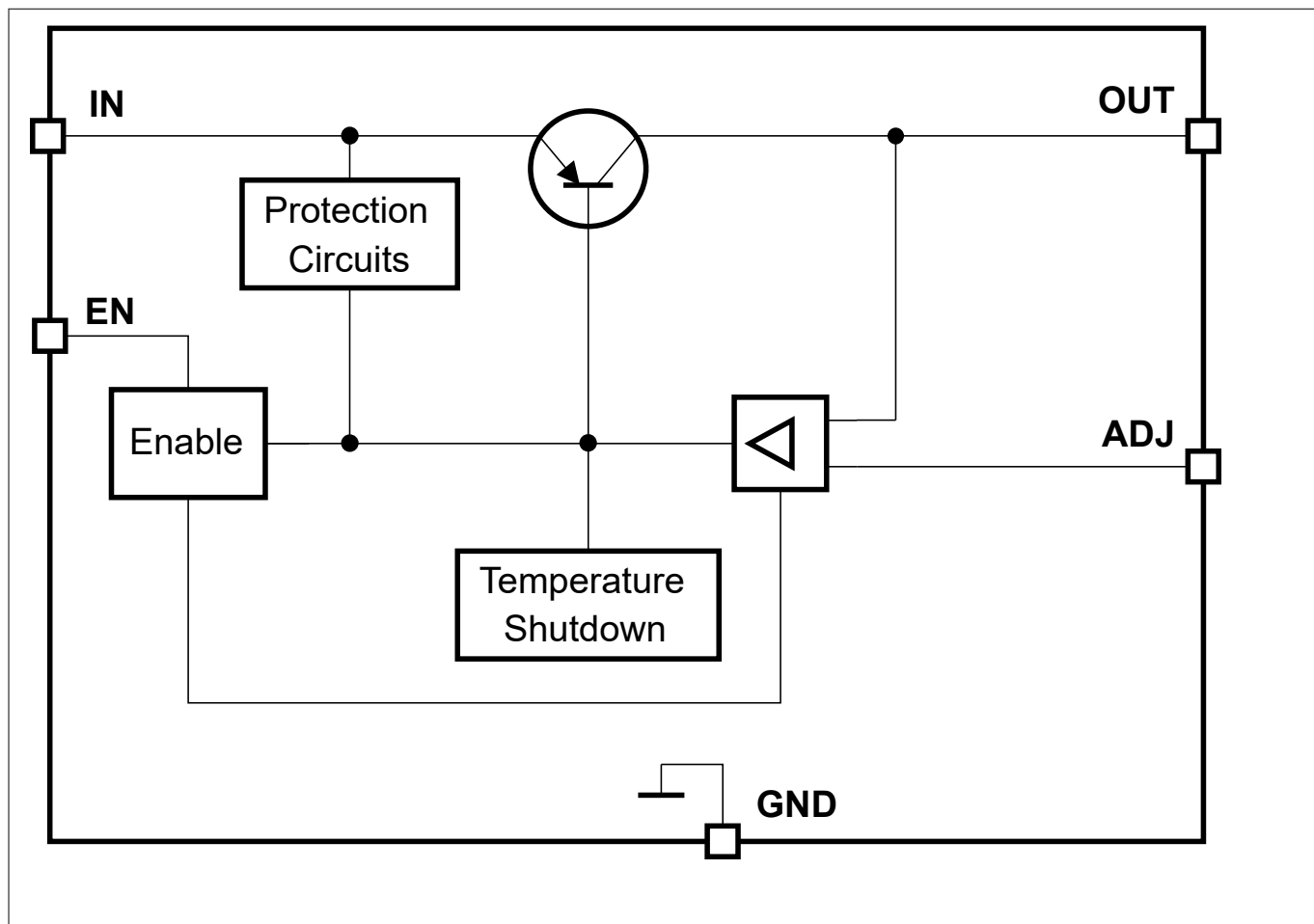

Figure 1 Block diagram

2 Pin configuration

2 Pin configuration

2.1 Pin assignment

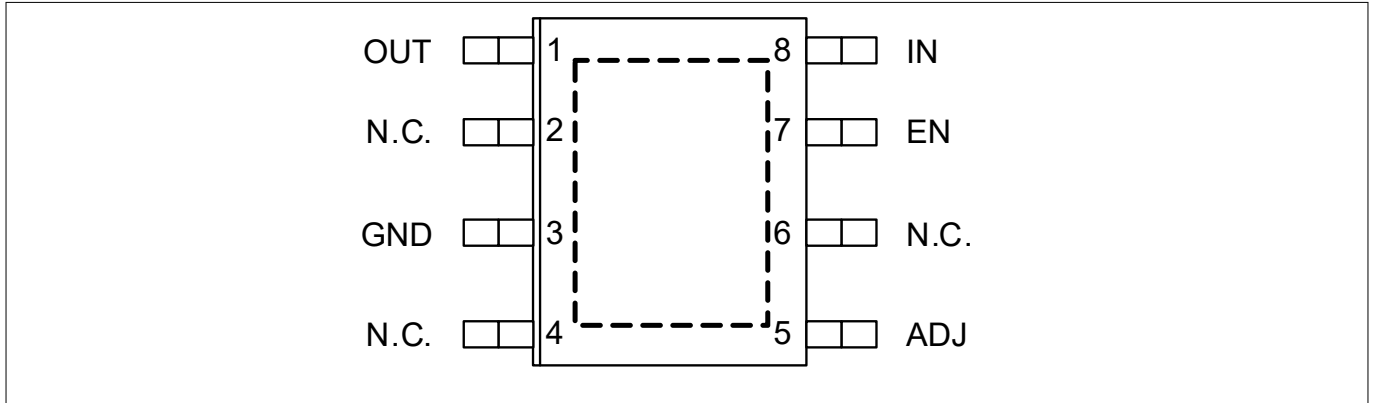

Figure 2 Pin configuration

2.2 Pin definitions and functions

Pin	Symbol	Function
1	OUT	Tracker output: 150 mA output current capability. Connect this pin to GND with a capacitor close to the pins, maintaining capacitance and ESR requirements given in Table 2 .
2	N.C.	Not connected
3	GND	Ground
4	N.C.	Not connected
5	ADJ	Adjust: Connect this pin to the reference voltage.
6	N.C.	Not connected
7	EN	Enable input: "High" signal enables the tracker. "Low" signal disables the tracker. If the enable function is not required, then connect EN to IN.
8	IN	Input: It is recommended to connect this pin to GND using a small ceramic capacitor close to the pins in order to compensate line influence.
Pad	-	Exposed pad: Connect the exposed pad to GND. It is recommended to connect the exposed pad to a heat sink.

3 General product characteristics

3 General product characteristics

3.1 Absolute maximum ratings

Table 1 Absolute maximum ratings¹⁾

$T_j = -40^\circ\text{C}$ to 150°C ; all voltages with respect to ground, positive current flowing into pin (unless otherwise specified)

Parameter	Symbol	Values			Unit	Note or condition	Number
		Min.	Typ.	Max.			
Input IN							
Voltage	V_{IN}	-16	-	45	V	-	P_3.1.1
Enable EN							
Voltage	V_{EN}	-16	-	45	V	-	P_3.1.2
Adjust ADJ							
Voltage	V_{ADJ}	-16	-	45	V	-	P_3.1.3
Output OUT							
Voltage	V_{OUT}	-5	-	45	V	-	P_3.1.4
Input output voltage difference							
Voltage	$V_{IN} - V_{OUT}$	-30	-	45	V	-	P_3.1.5
Temperatures							
Junction temperature	T_j	-40	-	150	°C	-	P_3.1.7
Storage temperature	T_{stg}	-55	-	150	°C	-	P_3.1.8
ESD Susceptibility							
ESD susceptibility to GND	$V_{ESD,HBM}$	-4	-	4	kV	²⁾ Human Body Model (HBM)	P_3.1.9
ESD susceptibility to GND	$V_{ESD,CDM}$	-1	-	1	kV	³⁾ Charged Device Model (CDM)	P_3.1.10
ESD susceptibility to GND	$V_{ESD,CDM}$	-1	-	1	kV	³⁾ Charged Device Model (CDM) at corner pins	P_3.1.11

1) Not subject to production test, specified by design.

2) Human body model (HBM) robustness according to ANSI/ESDA/JEDEC JS-001 (1.5 kΩ, 100 pF).

3) Charged device model (CDM) robustness according to JEDEC JESD22-C101.

Notes:

1. Stresses above the ones listed here may cause permanent damage to the device. Exposure to absolute maximum rating conditions for extended periods of time may affect device reliability.
2. Integrated protection functions are designed to prevent IC destruction under fault conditions described in the datasheet. Fault conditions are considered as outside the normal operating range. Protection functions are not designed for continuous repetitive operation.

3 General product characteristics

3.2 Functional range

Table 2 Functional range

Parameter	Symbol	Values			Unit	Note or condition	Number
		Min.	Typ.	Max.			
Input voltage range	V_{IN}	4	–	45	V	–	P_3.2.1
Adjust input voltage range (voltage tracking range)	V_{ADJ}	2	–	14	V	–	P_3.2.2
Capacitance of output capacitor	C_{OUT}	1	–	–	μF	1) 2)	P_3.2.3
Equivalent series resistance of output capacitor	$ESR_{C_{OUT}}$	–	–	5	Ω	2)	P_3.2.4
Junction temperature	T_j	-40	–	150	$^{\circ}\text{C}$	–	P_3.2.5

- 1) The minimum output capacitance requirement is applicable for a worst case capacitance tolerance of 30%.
 2) Not subject to production test, specified by design.

Note: Within the functional range, the IC operates as described in the circuit description. The electrical characteristics are specified within the conditions given in the electrical characteristics table.

3.3 Thermal resistance

Note: This thermal data was generated in accordance with JEDEC JESD51 standards. For more information, go to www.jedec.org.

Table 3 Thermal resistance

Parameter	Symbol	Values			Unit	Note or condition	Number
		Min.	Typ.	Max.			
Junction to case	R_{thJC}	–	18	–	K/W	1)	P_3.3.1
Junction to pin	R_{thJP}	–	85	–	K/W	–	P_3.3.2
Junction to ambient	R_{thJA}	–	50	–	K/W	2) 2s2p board	P_3.3.3
Junction to ambient	R_{thJA}	–	157	–	K/W	3) 1s0p board, footprint only	P_3.3.4
Junction to ambient	R_{thJA}	–	77	–	K/W	3) 1s0p board, 300 mm ² heatsink area on PCB	P_3.3.5
Junction to ambient	R_{thJA}	–	63	–	K/W	3) 1s0p board, 600 mm ² heatsink area on PCB	P_3.3.6

- 1) Not subject to production test, specified by design.
 2) Specified R_{thJA} value is according to JEDEC JESD51-2,-5,-7 at natural convection on FR4 2s2p board; the product (chip and package) was simulated on a 76.2 × 114.3 × 1.5 mm³ board with two inner copper layers (2 × 70 μm Cu, 2 × 35 μm Cu). Where applicable, a thermal via array next to the package contacted the first inner copper layer.
 3) Specified R_{thJA} value is according to JEDEC JESD51-3 at natural convection on FR4 1s0p board; the product (chip and package) was simulated on a 76.2 × 114.3 × 1.5 mm³ board with one copper layer (1 × 70 μm Cu).

3 General product characteristics

Note: *This thermal data was generated in accordance with JEDEC JESD51 standards. For more information visit www.jedec.org.*

4 Block description and electrical characteristics

4 Block description and electrical characteristics

4.1 Functional description tracking regulator

The regulator controls the output voltage V_{OUT} by comparing it to the voltage applied to the ADJ pin and driving a PNP pass transistor accordingly. The stability of the control loop depends on:

- The output capacitor C_{OUT}
- Load current
- Chip temperature
- The poles and zeroes in the frequency response of the circuit consisting of the TLS115B0EJ and the load

An input capacitor C_{IN} is strongly recommended for buffering the line influence.

To ensure stable operation, the output capacitor's capacitance and its equivalent series resistance *ESR* must fulfill the requirements in [Table 2](#). The output capacitor must be sized suitably to buffer load transients.

Connect each capacitor close to the pins.

The internal protection features are designed to protect the device itself as well as the application from destruction in case of catastrophic events. These safeguards contain:

- Output current limitation
- Reverse polarity protection
- Thermal shutdown

Output current limitation

In order to protect the pass element and the package from excessive power dissipation, the device limits the maximum output current at high input voltage.

Reverse polarity protection

The device allows a negative supply voltage. However, in reverse polarity condition several small currents flowing into the device increase the junction temperature. Thermal design must consider this effect, because in reverse polarity condition the overtemperature protection circuit does not operate.

Thermal shutdown

The overtemperature protection circuit is designed to prevent immediate destruction of the device in certain fault conditions (for example a permanent short circuit at output) by switching off the power stage. After the chip cools down, the regulator restarts. If the fault is not removed, then this leads to an oscillatory behavior of the output voltage. A junction temperature above 150°C is outside the maximum ratings and reduces the lifetime of the device.

4 Block description and electrical characteristics

4.2 Electrical characteristics tracking regulator

Table 4 Electrical characteristics tracking regulator

$V_{IN} = 13.5\text{ V}$; $2.0\text{ V} \leq V_{ADJ} \leq 14\text{ V}$; $V_{EN} \geq 2.0\text{ V}$; $T_j = -40^\circ\text{C}$ to 150°C ; all voltages with respect to ground, positive current flowing into pin (unless otherwise specified).

Parameter	Symbol	Values			Unit	Note or condition	Number
		Min.	Typ.	Max.			
Tracking output							
Output voltage tracking accuracy	ΔV_{OUT}	-5	-	5	mV	$\Delta V_{OUT} = V_{ADJ} - V_{OUT}$; $5.5\text{ V} \leq V_{IN} \leq 22\text{ V}$; $0.1\text{ mA} \leq I_{OUT} \leq 150\text{ mA}$; $2\text{ V} \leq V_{ADJ} \leq V_{IN} - 1\text{ V}$	P_4.1.1
Output voltage tracking accuracy	ΔV_{OUT}	-5	-	5	mV	$\Delta V_{OUT} = V_{ADJ} - V_{OUT}$; $5.5\text{ V} \leq V_{IN} \leq 32\text{ V}$; $0.1\text{ mA} \leq I_{OUT} \leq 70\text{ mA}$; $2\text{ V} \leq V_{ADJ} \leq V_{IN} - 1\text{ V}$	P_4.1.2
Load regulation steady-state	$\Delta V_{OUT,load}$	-4	-0.1	-	mV	$I_{OUT} = 0.1\text{ mA}$ to 150 mA ; $V_{ADJ} = 5\text{ V}$	P_4.1.3
Line regulation steady-state	$\Delta V_{OUT,line}$	-	0.1	4	mV	$V_{IN} = 5.5\text{ V}$ to 32 V ; $I_{OUT} = 10\text{ mA}$; $V_{ADJ} = 5\text{ V}$	P_4.1.4
Power supply ripple rejection	PSRR	-	85	-	dB	¹⁾ $f_{ripple} = 100\text{ Hz}$; $V_{ripple} = 1\text{ V}_{pp}$; $I_{OUT} = 10\text{ mA}$; $C_{OUT} = 10\text{ }\mu\text{F}$, ceramic type	P_4.1.5
Output current limitation	$I_{OUT,max}$	151	350	500	mA	$V_{OUT} = V_{ADJ} - 0.1\text{ V}$; $V_{ADJ} = 5\text{ V}$	P_4.1.6
Reverse current	$I_{OUT,rev}$	-3.5	-1.7	-	mA	$V_{IN} = 0\text{ V}$; $V_{OUT} = 16\text{ V}$; $V_{ADJ} = 5\text{ V}$	P_4.1.9
Reverse current at negative input voltage	$I_{IN,rev}$	-4	-2	-	mA	$V_{IN} = -16\text{ V}$; $V_{OUT} = 0\text{ V}$; $V_{ADJ} = 5\text{ V}$	P_4.1.10
Dropout voltage	V_{dr}	-	250	500	mV	²⁾ $V_{dr} = V_{IN} - V_{OUT}$; $I_{OUT} = 150\text{ mA}$; $V_{ADJ} = 5\text{ V}$	P_4.1.11

(table continues...)

4 Block description and electrical characteristics

Table 4 (continued) Electrical characteristics tracking regulator

$V_{IN} = 13.5\text{ V}$; $2.0\text{ V} \leq V_{ADJ} \leq 14\text{ V}$; $V_{EN} \geq 2.0\text{ V}$; $T_j = -40^\circ\text{C}$ to 150°C ; all voltages with respect to ground, positive current flowing into pin (unless otherwise specified).

Parameter	Symbol	Values			Unit	Note or condition	Number
		Min.	Typ.	Max.			
Overtemperature protection							
Overtemperature shutdown threshold	$T_{j,sd}$	–	175	–	$^\circ\text{C}$	T_j increasing due to power dissipation generated by the device	P_4.1.15
Overtemperature shutdown threshold hysteresis	$\Delta T_{j,sdh}$	–	15	–	K	–	P_4.1.16

1) Not subject to production test, specified by design.

2) Measured when the output voltage V_{OUT} has dropped 100 mV from the nominal value obtained at $V_{IN} = 13.5\text{ V}$.

4 Block description and electrical characteristics

4.3 Typical performance characteristics tracking regulator

Tracking accuracy ΔV_{OUT} versus junction temperature T_j

Output current limitation $I_{OUT,max}$ versus input voltage V_{IN}

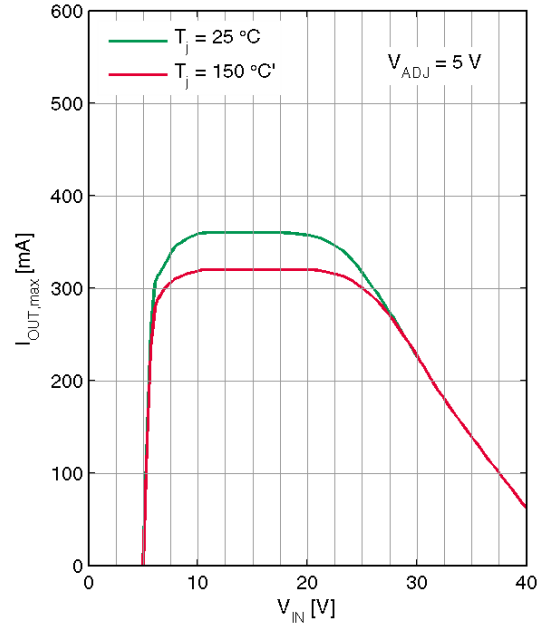
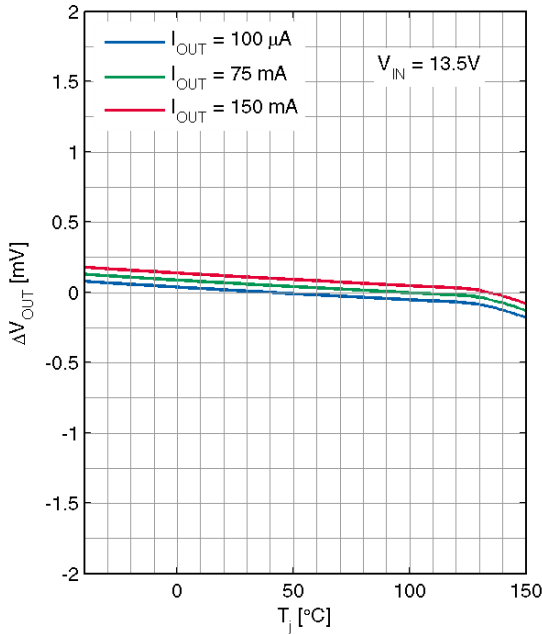

Output voltage V_{OUT} versus adjust voltage V_{ADJ}

Output voltage V_{OUT} versus input voltage V_{IN}

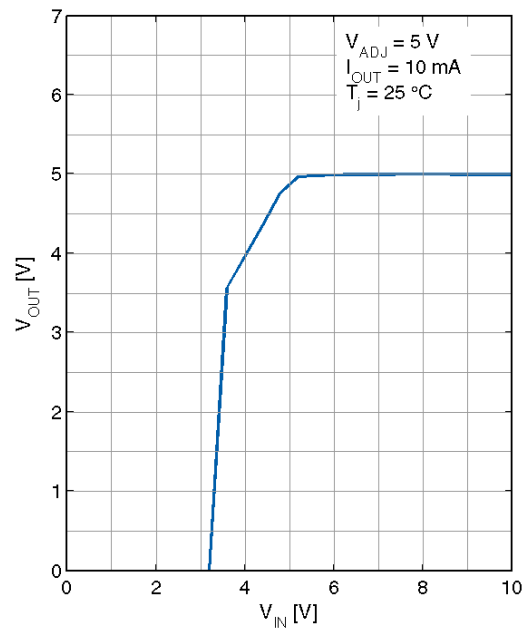
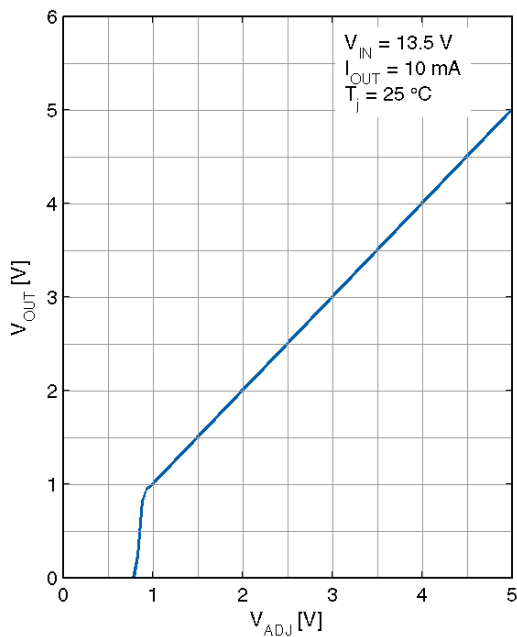

4 Block description and electrical characteristics

Load regulation $\Delta V_{OUT,load}$ versus output current I_{OUT}

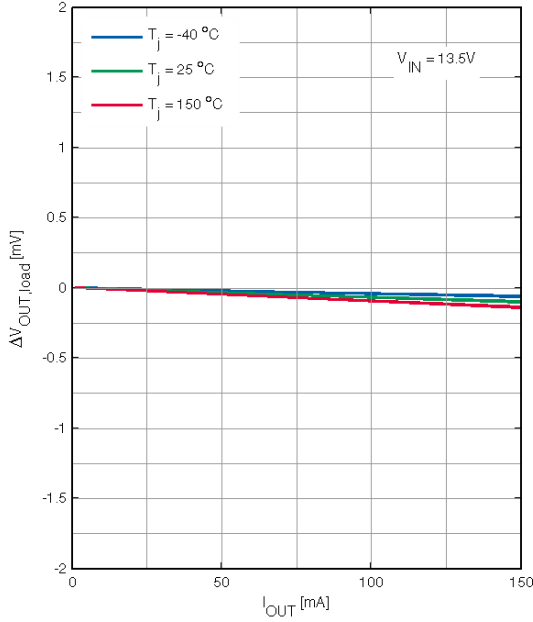

Line regulation $\Delta V_{OUT,line}$ versus input voltage V_{IN}

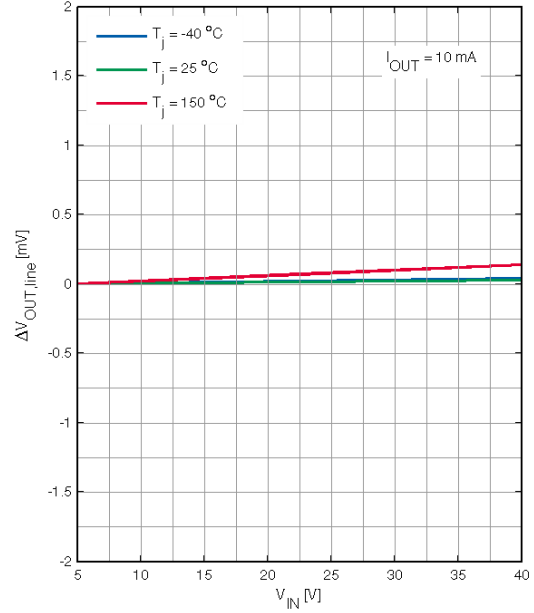

Dropout voltage V_{dr} versus junction temperature T_j

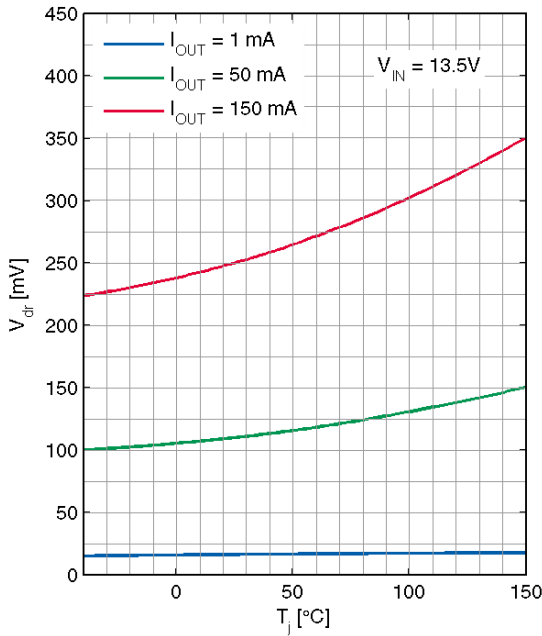

Dropout voltage V_{dr} versus output current I_{OUT}

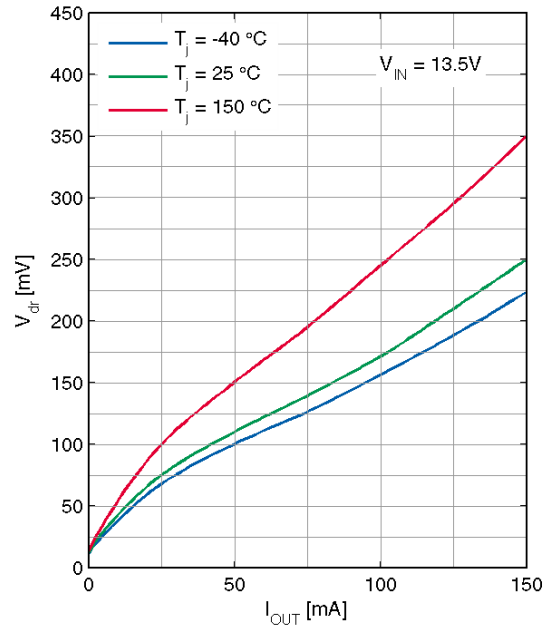

4 Block description and electrical characteristics

Reverse current $I_{IN,rev}$ versus input voltage V_{IN}

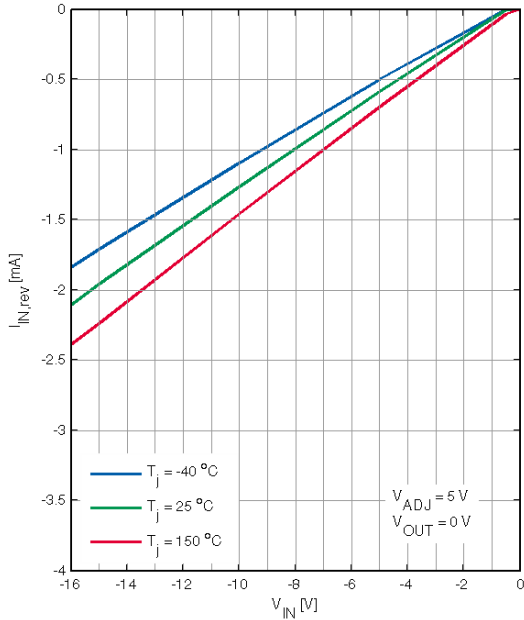

Reverse current $I_{OUT,rev}$ versus output voltage V_{OUT}

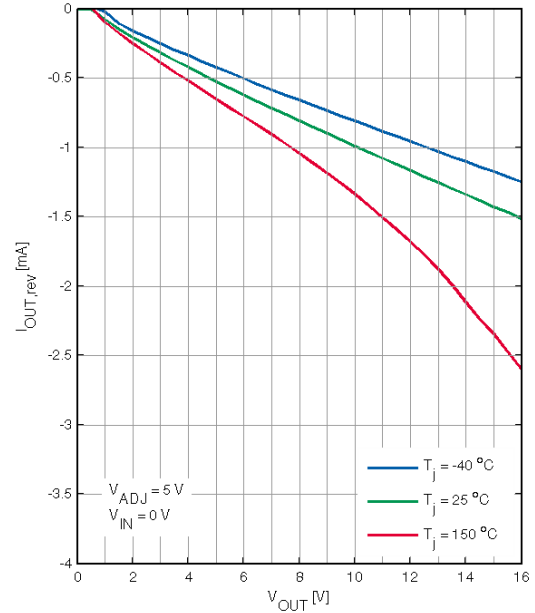

Power supply ripple rejection $PSRR$ versus ripple frequency f_r

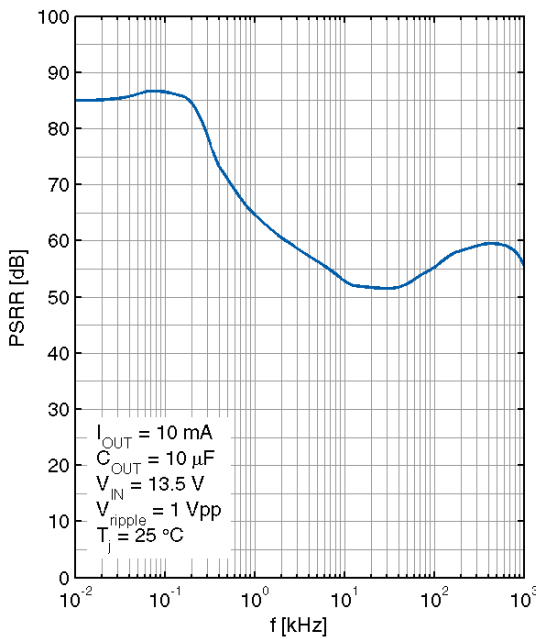

Output capacitor $ESR_{C_{OUT}}$ versus output current I_{OUT}

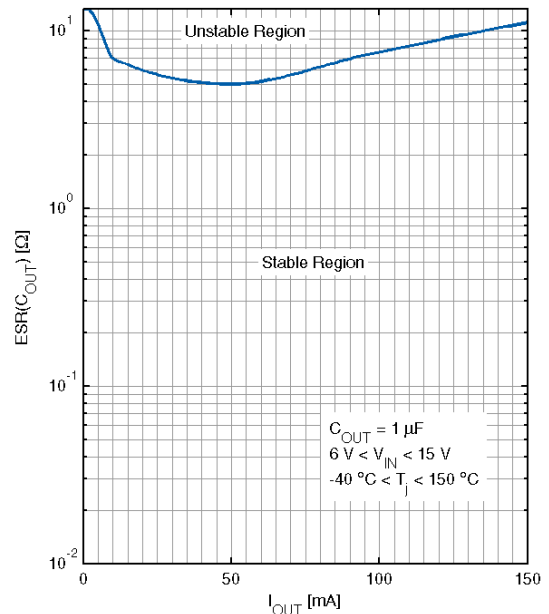

4 Block description and electrical characteristics

4.4 Electrical characteristics current consumption

Table 5 Electrical characteristics current consumption

$V_{IN} = 13.5\text{ V}$; $2.0\text{ V} \leq V_{ADJ} \leq 14\text{ V}$; $V_{EN} \geq 2.0\text{ V}$; $T_j = -40^\circ\text{C}$ to 150°C ; all voltages with respect to ground, positive current flowing into pin (unless otherwise specified).

Parameter	Symbol	Values			Unit	Note or condition	Number
		Min.	Typ.	Max.			
Current consumption stand-by mode	$I_{q,off}$	–	0.1	5	μA	$I_{q,off} = I_{IN}$; $V_{EN} \leq 0.4\text{ V}$; $T_j \leq 125^\circ\text{C}$	P_4.3.1
Current consumption	I_q	–	55	90	μA	$I_q = I_{IN} - I_{OUT}$; $I_{OUT} \leq 0.1\text{ mA}$; $V_{ADJ} = 5\text{ V}$; $T_j \leq 125^\circ\text{C}$	P_4.3.2
Current consumption	I_q	–	7	14	mA	$I_q = I_{IN} - I_{OUT}$; $I_{OUT} \leq 150\text{ mA}$; $V_{ADJ} = 5\text{ V}$	P_4.3.3

4 Block description and electrical characteristics

4.5 Typical performance characteristics current consumption

Current consumption I_q versus output current I_{OUT}

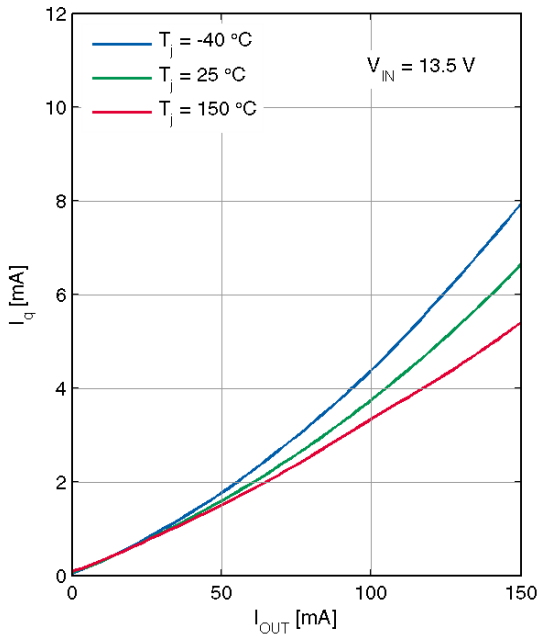

Current consumption I_q versus input voltage V_{IN}

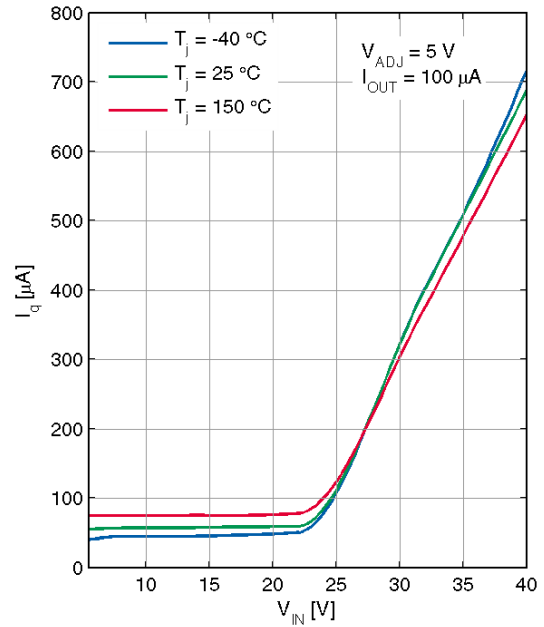

Current consumption I_q versus junction temperature T_j

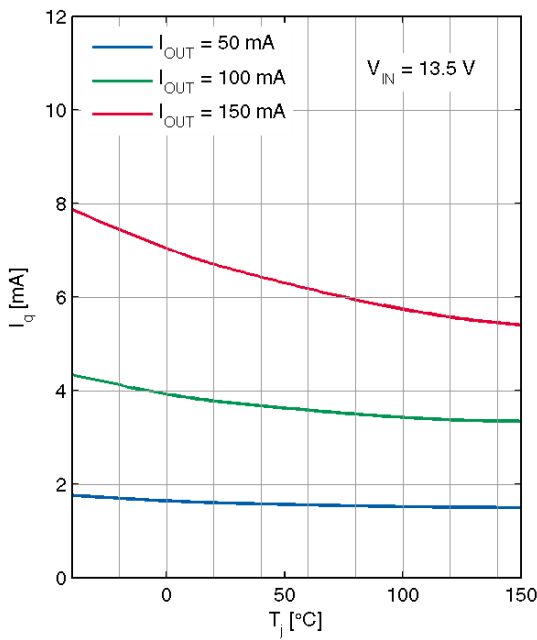

Current consumption I_q versus junction temperature T_j (I_{OUT} low)

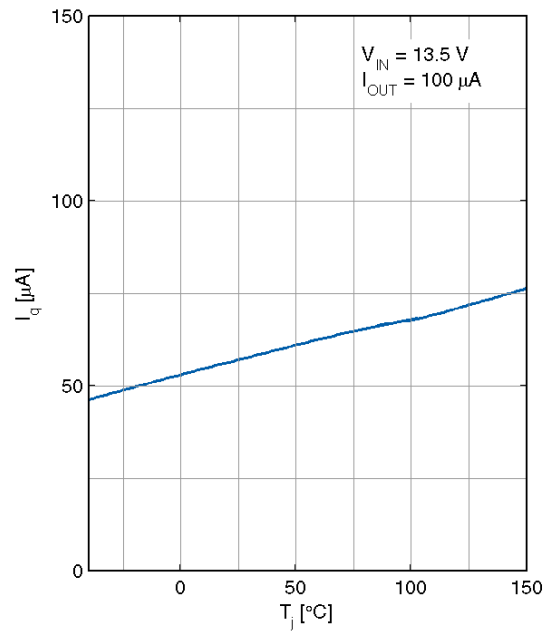

4 Block description and electrical characteristics

Current consumption in off-mode $I_{q,off}$ versus junction temperature T_j

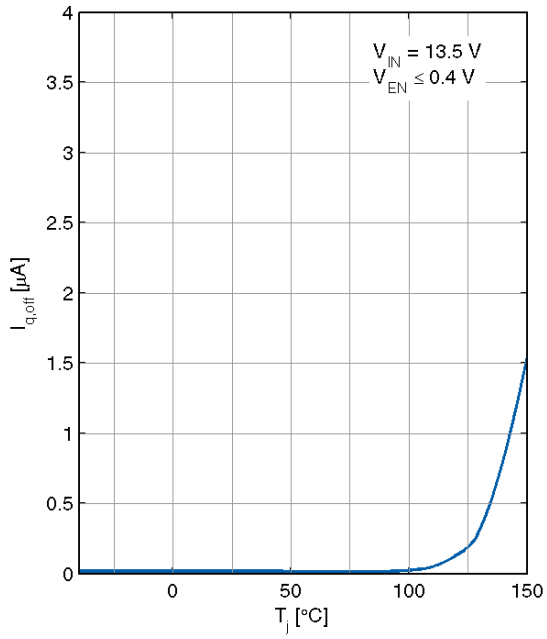

4 Block description and electrical characteristics

4.6 Functional description enable input

On a "low" signal at the enable input EN the device switches to standby mode in order to minimize the quiescent current.

If the EN pin is not connected, then the "low" level from the internal pull-down resistor switches off the regulator.

4.7 Electrical characteristics enable input

Table 6 Electrical characteristics enable input

$V_{IN} = 13.5\text{ V}$; $2.0\text{ V} \leq V_{ADJ} \leq 14\text{ V}$; $T_j = -40^\circ\text{C}$ to 150°C ; all voltages with respect to ground, positive current flowing into pin (unless otherwise specified).

Parameter	Symbol	Values			Unit	Note or condition	Number
		Min.	Typ.	Max.			
Enable off voltage range	$V_{EN,off}$	–	–	0.8	V	$V_{OUT} = 0\text{ V}$; $I_{OUT} \leq 5\ \mu\text{A}$; $T_j \leq 125^\circ\text{C}$	P_4.5.1
Enable on voltage range	$V_{EN,on}$	2	–	–	V	V_{OUT} settled	P_4.5.2
Enable input current	I_{EN}	–	2	4	μA	$V_{EN} = 5\text{ V}$	P_4.5.3

4 Block description and electrical characteristics

4.8 Typical performance characteristics enable input

Enable input current I_{EN} versus
enable input voltage V_{EN}

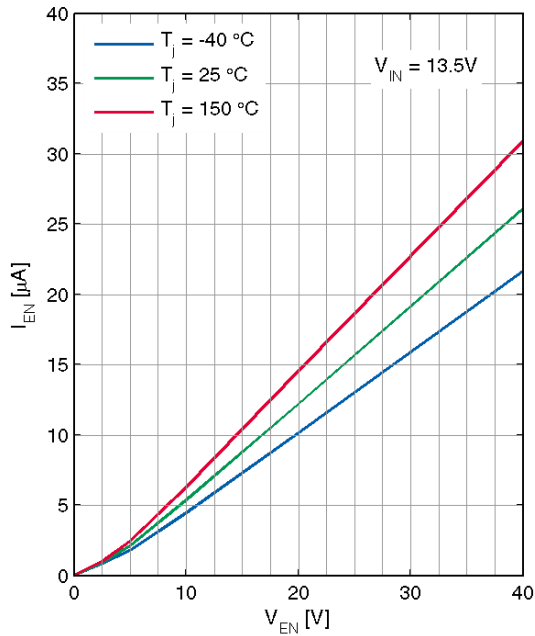

4 Block description and electrical characteristics

4.9 Functional description adjust input

The adjust input must be connected to the reference voltage that the device tracks.

4.10 Electrical characteristics adjust input

Table 7 Electrical characteristics adjust input

$V_{IN} = 13.5\text{ V}$; $2.0\text{ V} \leq V_{ADJ} \leq 14\text{ V}$; $V_{EN} \geq 2.0\text{ V}$; $T_j = -40^\circ\text{C}$ to 150°C ; all voltages with respect to ground, positive current flowing into pin (unless otherwise specified).

Parameter	Symbol	Values			Unit	Note or condition	Number
		Min.	Typ.	Max.			
Adjust input current	I_{ADJ}	–	0.03	1	μA	$V_{ADJ} = 5\text{ V}$	P_4.7.1

4 Block description and electrical characteristics

4.11 Typical performance characteristics adjust input

Adjust input current I_{ADJ} versus
 adjust input voltage V_{ADJ}

Adjust input current I_{ADJ} versus
 junction temperature T_j

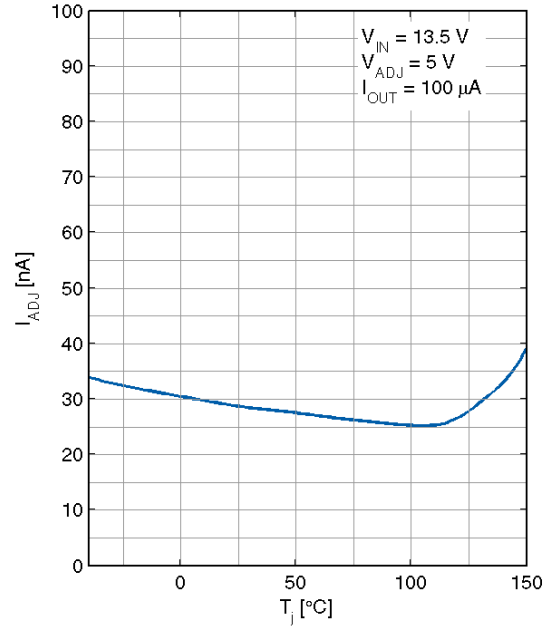
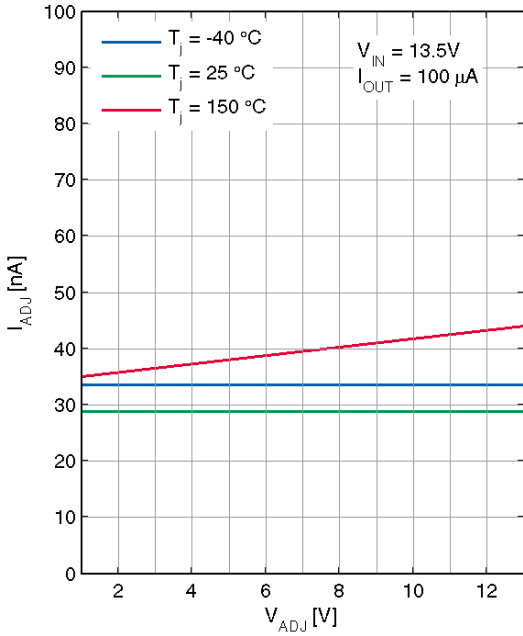

5 Application information

5 Application information

Note: *The following information is given as an example for the implementation of the device only and shall not be regarded as a description or warranty of a certain functionality, condition or quality of the device.*

5.1 Application diagram

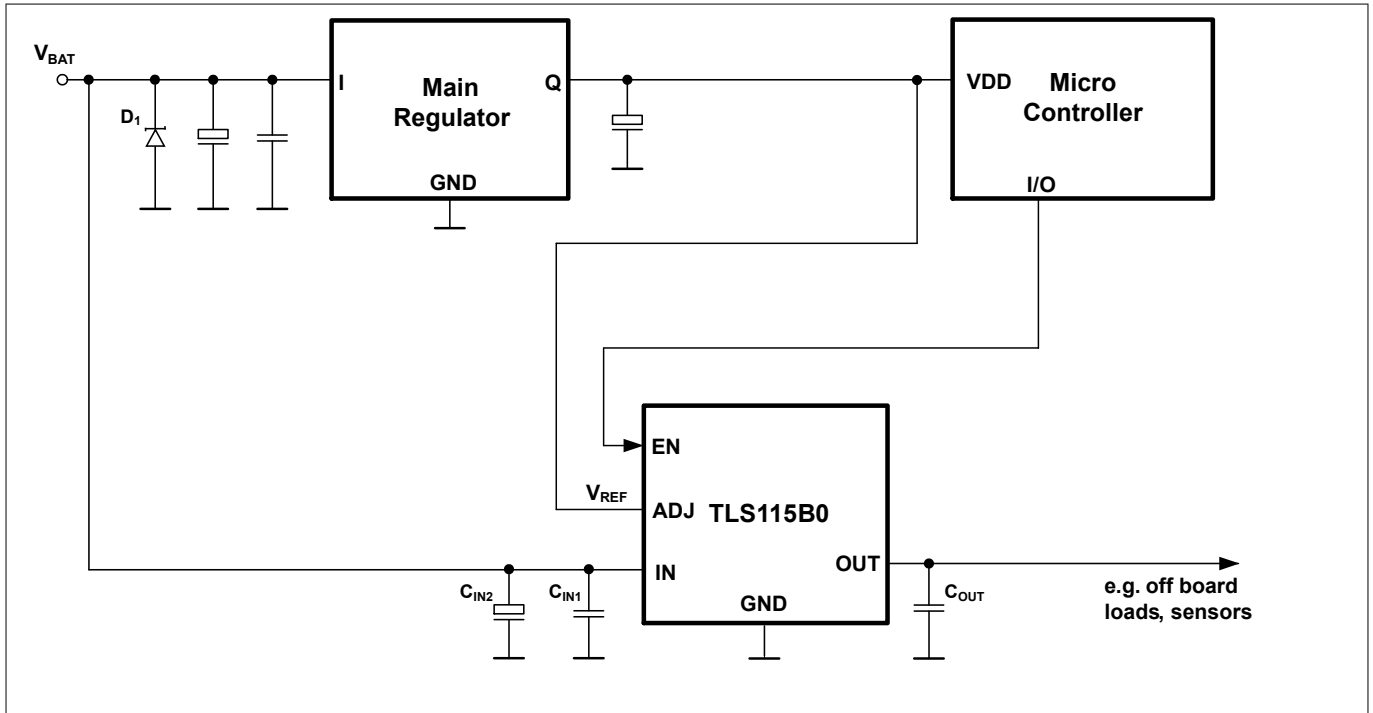

Figure 3 Application diagram

Note: *This figure is a simplified example of an application circuit. The function must be verified in the application.*

5.2 Selection of external components

5.2.1 Input pin

Figure 3 shows the typical input circuitry for a voltage tracking regulator. The following external components at the input are recommended in case of possible external disturbance.

Ceramic capacitor

A ceramic capacitor C_{IN1} (100 nF to 470 nF) at the input filters high frequency disturbance imposed by the line, such as ISO pulses 3a/b. Place C_{IN1} as close as possible to the input pin of the voltage tracking regulator on the PCB.

Aluminum electrolytic capacitor

An aluminum electrolytic capacitor C_{IN2} (10 μ F to 470 μ F) at the input smoothens high energy pulses, such as ISO pulse 2a. Place C_{IN2} close to the input pin of the voltage tracking regulator on the PCB.

5 Application information

Overvoltage suppression diode

A suitably sized diode D_1 suppresses high voltage beyond the maximum ratings of the circuit components and protects the device from damage due to overvoltage.

5.2.2 Output pin

An output capacitor C_{OUT} is necessary for the stability of the voltage tracking regulator, see Functional range. The typical performance graph [Output capacitor ESR \$C_{OUT}\$ versus output current \$I_{OUT}\$](#) shows the stable operation range of the device.

In an automotive environment, ceramic capacitors with X5R or X7R dielectrics are recommended.

Place C_{OUT} on the same side of the PCB as the device and as close as possible to both the OUTpin and the GND pin.

In case of rapid transients of input voltage or load current, C_{OUT} must be dimensioned accordingly to ensure the output stability in the application.

5.2.3 Adjust pin

[Figure 3](#) shows a typical adjust circuitry for a voltage tracking regulator. Typically the adjust pin is connected to a fixed voltage reference that the regulator tracks. In the example of the application diagram ADJ is connected to the supply voltage of a microcontroller. Alternatively, the voltage reference can also be adjusted by a voltage divider.

5.3 Thermal considerations

From the known input voltage, the output voltage and the load profile of the application, the total power dissipation can be calculated:

$$P_D = (V_{IN} - V_{OUT}) \times I_{OUT} + V_{IN} \times I_q$$

Equation 1

with

- P_D : continuous power dissipation
- V_{IN} : input voltage
- V_{OUT} : output voltage
- I_{OUT} : output current
- I_q : quiescent current

The maximum acceptable thermal resistance R_{thJA} can then be calculated:

$$R_{thJA, max} = \frac{T_{j, max} - T_a}{P_D}$$

Equation 2

with

- $T_{j, max}$: maximum allowed junction temperature
- T_a : ambient temperature

Based on the above calculation the proper PCB type and the necessary heat sink area can be determined with reference to the specification in [Thermal resistance](#).

5 Application information

Example

Application conditions:

$$V_{IN} = 13.5 \text{ V}$$

$$V_{OUT} = V_{ADJ} = 5 \text{ V}$$

$$I_{OUT} = 100 \text{ mA}$$

$$T_a = 75^\circ\text{C}$$

Calculation of $R_{thJA,max}$:

$$P_D = (V_{IN} - V_{OUT}) \times I_{OUT} + V_{IN} \times I_q$$

$$= (13.5\text{V} - 5\text{V}) \times 100 \text{ mA} + 13.5 \text{ V} \times 3.5 \text{ mA}$$

$$= 0.897 \text{ W}$$

$$R_{thJA,max} = (T_{j,max} - T_a) / P_D$$

$$= (150^\circ\text{C} - 75^\circ\text{C}) / 0.897 \text{ W}$$

$$= 83.6 \text{ K/W}$$

As a result, the PCB design must ensure a thermal resistance R_{thJA} lower than 83.6 K/W. According to [Thermal resistance](#), at least 300 mm² heat sink area is required on the FR4 1s0p PCB, or the FR4 2s2p board can be used.

5.4 Further application information

- For further information you may contact <http://www.infineon.com/>

6 Package information

6 Package information

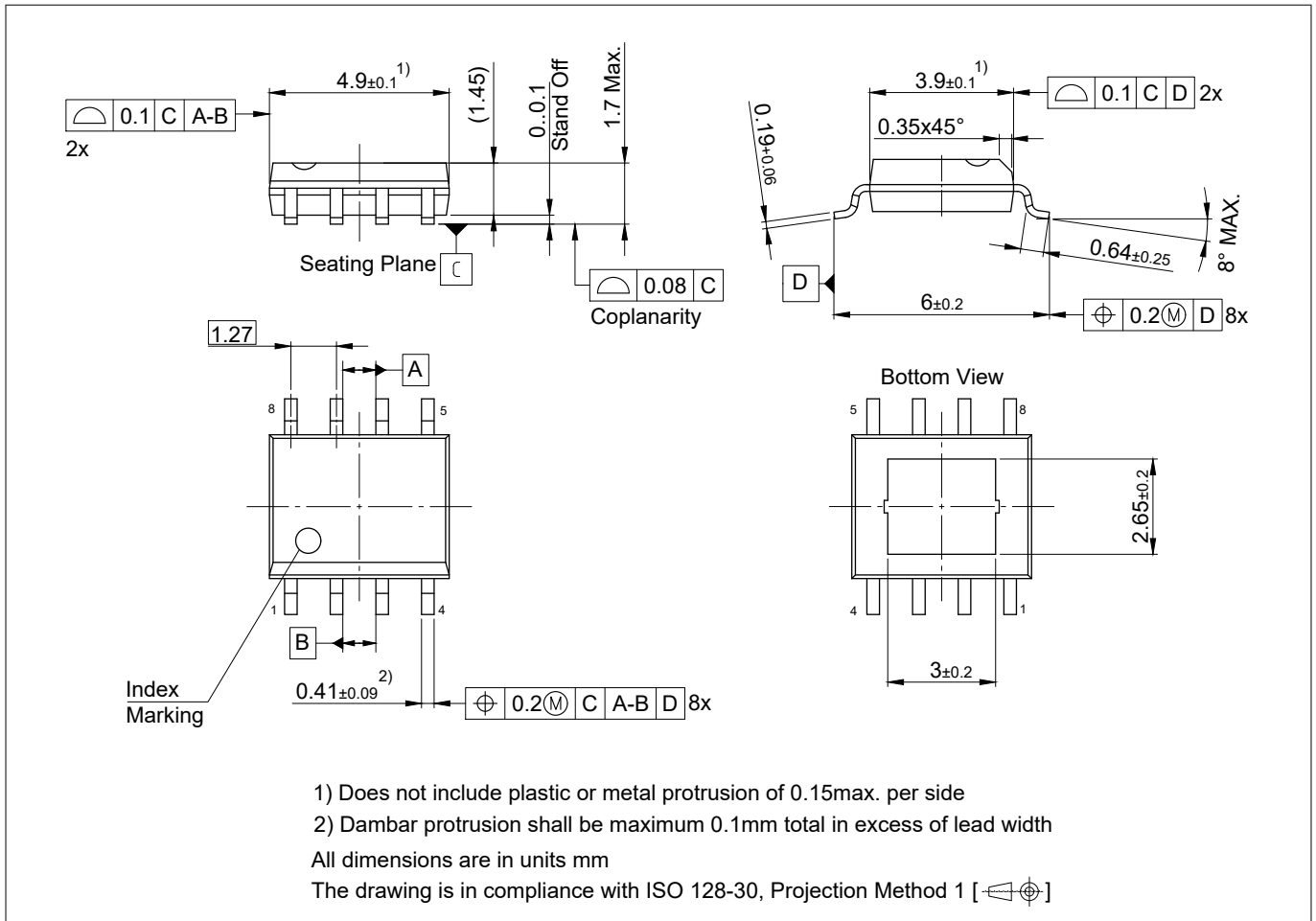

Figure 4 PG-DSO-8

Green Product (RoHS compliant)

To meet the world-wide customer requirements for environmentally friendly products and to be compliant with government regulations the device is available as a Green Product. Green Products are RoHS compliant (Pb-free finish on leads and suitable for Pb-free soldering according to IPC/JEDEC J-STD-020).

Information on alternative packages

Please visit www.infineon.com/packages.

Revision history

Revision history

Revision	Date	Changes
1.13	2024-03-20	Datasheet updated: <ul style="list-style-type: none">• Marking corrected
1.12	2022-11-10	Datasheet updated: <ul style="list-style-type: none">• Editorial changes
1.11	2021-05-28	Datasheet updated: <ul style="list-style-type: none">• Editorial changes
1.1	2020-03-19	Datasheet updated: <ul style="list-style-type: none">• P_3.1.5 maximum value for input output voltage difference added• Editorial changes
1.0	2016-10-13	Datasheet created

Trademarks

All referenced product or service names and trademarks are the property of their respective owners.

Edition 2024-03-20

Published by

Infineon Technologies AG

81726 Munich, Germany

© 2024 Infineon Technologies AG

All Rights Reserved.

Do you have a question about any aspect of this document?

Email: erratum@infineon.com

Document reference

IFX-mdd1636994113371

Z8F55515725

Important notice

The information given in this document shall in no event be regarded as a guarantee of conditions or characteristics ("Beschaffheitsgarantie").

With respect to any examples, hints or any typical values stated herein and/or any information regarding the application of the product, Infineon Technologies hereby disclaims any and all warranties and liabilities of any kind, including without limitation warranties of non-infringement of intellectual property rights of any third party.

In addition, any information given in this document is subject to customer's compliance with its obligations stated in this document and any applicable legal requirements, norms and standards concerning customer's products and any use of the product of Infineon Technologies in customer's applications.

The data contained in this document is exclusively intended for technically trained staff. It is the responsibility of customer's technical departments to evaluate the suitability of the product for the intended application and the completeness of the product information given in this document with respect to such application.

Warnings

Due to technical requirements products may contain dangerous substances. For information on the types in question please contact your nearest Infineon Technologies office.

Except as otherwise explicitly approved by Infineon Technologies in a written document signed by authorized representatives of Infineon Technologies, Infineon Technologies' products may not be used in any applications where a failure of the product or any consequences of the use thereof can reasonably be expected to result in personal injury.